

10 13 20 25 30 40 45 50 55 60 65 70 75 80 85 90



# PERFORMANCE

## 2018

MOVING INTO THE FUTURE



# COMPANY



Da oltre 45 anni Sirman produce le migliori attrezzature per i Professionisti della Cucina e della distribuzione organizzata.

Dalla prima idea imprenditoriale del fondatore Nereo Marzaro ad oggi, l'azienda si è evoluta costantemente grazie ad una moderna ed efficiente organizzazione interna e ad un team d'eccellenza che opera affinché i prodotti Sirman, interamente progettati e realizzati in Italia, siano presenti in oltre 500 punti vendita nel mercato nazionale e in 125 paesi nel resto del mondo.

Oggi l'azienda è riconosciuta come leader nel settore grazie ad un'ampia gamma di attrezzature, caratterizzate dalla perfetta combinazione di tecnologia e affidabilità, design innovativo e funzionalità, destinate a soddisfare nel migliore dei modi le esigenze di ristoranti, bar, pizzerie, macellerie, salumerie, supermercati, laboratori e industrie alimentari. Un ottimo risultato ottenuto grazie alle brillanti intuizioni dei tecnici e progettisti che, nei laboratori attrezzati con le più avanzate tecnologie, sono impegnati ogni giorno nella ricerca e sviluppo di soluzioni efficaci e innovative per arricchire la gamma già molto ampia dei prodotti Sirman.

Un ufficio tecnico R&D di 12 persone, con 8 stazioni di modellazione solida tridimensionale, gestisce tutte le fasi di studio e progettazione di ogni macchina che esce dai propri stabilimenti produttivi. In contemporanea la forza vendita opera un incessante lavoro di indagine del mercato per individuare i nuovi trend e rimanere sempre sintonizzati sulle reali esigenze dei clienti. Una sinergia di collaborazioni ad altissima professionalità che ha portato Sirman ad affermarsi come l'unico vero partner globale nel mercato italiano e significativa realtà a livello internazionale.

*For more than 45 years Sirman has been manufacturing the finest food processing machines for the professional kitchen and retail industry.*

*From the entrepreneurial idea of the Founder Nereo Marzaro to the present time, Sirman has constantly committed with a high level of organization and teamwork to fulfill the needs of over 500 dealers nationally and 125 countries worldwide with products entirely designed and made in Italy.*

*Today Sirman is a leader in the industry thanks to the most comprehensive range of food processing machines, designed with a perfect combination of technology and dependability, innovations and solutions to meet and exceed the demands of restaurants, bars, pizzerias, butcheries, supermarkets, laboratories, collectivities and plants. This is the outstanding result of Engineers working every day in high tech departments for the research and development of effective solutions to further expand the line.*

*The research & development department boasting 12 Engineers with 8 3D modeling stations to manage all stages of the product development process in conjunction to the Sales Force focused on understanding and addressing the rising and ever changing needs of the Customers to create a high-level strategy to be the only global partner in the Italian marketplace and internationally well-recognized.*





**Sirman ITALIA**  
Headquarter

**Sirman**  
Fattorie



#### SIRMAN ASSEMBLY

Un modernissimo impianto di assemblaggio che precorre i tempi, dotato di magazzino automatizzato da 2.650 posti pallet a servizio dei reparti di assemblaggio che offre flessibilità e velocità ai lanci di produzione orientati sia a ricaricare il magazzino prodotti finiti che alla gestione di produzioni OEM. Il sistema di assemblaggio ad isole specializzate responsabilizza il singolo che segue l'intera fase di assemblaggio. L'esperienza e la perizia del personale permettono di contare su di uno standard qualitativo degno della miglior tradizione meccanica italiana, indispensabile per le affettatrici più prestigiose, piccoli gioielli di raffinata meccanica. L'attenzione alle persone e all'ambiente che contraddistingue da sempre la filosofia di Sirman ha portato a completare questo stabile di 3.200 mq con una installazione fotovoltaica da 50 Kw e un innovativo impianto di riscaldamento a pavimento, che permette alle oltre 40 persone impiegate di lavorare nel massimo comfort anche nei mesi invernali.

*An ultra-modern assembly plant of 3.200 m<sup>2</sup> provided with an automatic storage and retrieval system, capable of 2.650 pallets to ensure availability of material at each stage of the production process, enhance flexibility and production flow for both stock replenishment and OEM custom made product. The assembly system split into dedicated areas for each product raises Sirman Workers' responsibility and confidence during the whole assembly process. At the same time Sirman Workers' skills and expertise qualify for the highest degree of quality, worthy of the finest tradition of Italian mechanics, necessary when it comes to the assembly heavy-duty slicers, genuine masterpieces of refined mechanics. The social responsibility to Employees and the responsibility to the environment and natural resources are vital codes of Sirman mission sustained by the installation of a 50 Kw photovoltaic system and an innovative floor heating system for a safe and comfortable working environment.*



#### SIRMAN TECHNICS

Struttura di 2.700 mq dedicata alle lavorazioni meccaniche su tutte le tipologie dei prodotti Sirman. Orgoglio dell'azienda per organizzazione ed efficienza, il reparto gestisce ben 5 centri di lavoro doppia tavola organizzati in 3 turni di lavoro. Il nuovo reparto pulitura robotizzata che gestisce due bracci Kawasaki e 10 cosiddette "torrette intelligenti" è oggi tra i più avanzati al mondo in grado di offrire risultati perfetti anche senza l'intervento umano. Un lavoro storicamente duro e difficile oggi è diventato agevole e dignitoso grazie agli investimenti operati dall'azienda in automazione e grazie ad un superbo impianto di aspirazione e smaltimento delle polveri.

*Sirman takes pride of a highly-efficient 2700 m<sup>2</sup> metal machining and tooling infrastructure, featuring 5 automatic work centers operating with 3 shifts a day. The new robotic polishing system provided with two Kawasaki robots and 10 different matrix styles is today one of the most advanced worldwide able to achieve perfect results without human interaction. Metal polishing is notoriously a hard and unhealthy work, made easy and secure by Sirman thanks to the investments in automation and a state of the art powder and residues extraction and disposal system.*



#### ITAL CENTRO

6.000 mq divisi in 3 reparti produttivi separati che gestiscono: il primo la produzione di vetrinette, piastre ad induzione e vari altri apparecchi per la cottura, il secondo tutte le macchine bar e i frullatori ad immersione, il terzo piastre grill, tostiere e forni pizza. Quest'ultimo autosufficiente anche per la produzione e finitura dei lamierati in acciaio inox.

*6.000 m<sup>2</sup> split into 3 production areas. One area has been dedicated to the production of food displays, induction hobs and other modern cooking products, the second one to the production of all bar and beverage machines and immersion blenders, finally the third one is provided with a machining center for stainless steel for the production of panini contact grills, toasters and pizza ovens.*



**Sirman USA**  
Chicago



**Sirman China**  
Shanghai



**Sirman Brasil**  
Balneario Camboriú

Oggi Sirman vanta 8 unità produttive in terra Veneta all'insegna del miglior 'Made in Italy' e due sedi commerciali estere con magazzino e assistenza, di cui una a Chicago dal 1999 e una a Shanghai dal 2005. A queste si è aggiunto nel 2016 un investimento dedicato esclusivamente al mercato Brasiliano, con una struttura sia a servizio della distribuzione del prodotto SIRMAN, ma anche produttiva, per seguire al meglio un mercato chiuso, molto difficile, ma ancora in forte espansione.

Nella sede centrale si trovano il magazzino spedizioni, il controllo qualità, gli uffici e il reparto ricerca e sviluppo che conta su 8 stazioni di modellazione solida tridimensionale per seguire lo sviluppo e la messa in produzione di tutti i prodotti dell'azienda.

*Today Sirman boasts eight manufacturing facilities, proudly located in the Veneto area for the best Made in Italy products, a Chicago branch office since 1999 and a Shanghai one since 2005, both provided with a stocking warehouse and service to better serve the US and Chinese market. Since 2016 a further investment has taken place in Brazil both for the distribution of the "Sirman Made in Italy" products and for the production of slicers dedicated to the internal market, still very difficult and closed, but still incredibly dynamic. The Headquarter hosts all offices, the logistics department and the R&D, where 8 3D modeling stations manage all stages of the product development process with CAD, CAM and 3d printing facilities.*



### SIRMAN 3

Ultimo nato tra i reparti produttivi di Sirman, quello dedicato alla produzione delle macchine sottovuoto. Prodotto in forte crescita numerica e sviluppo di gamma nel pacchetto Sirman che sta dando ottime soddisfazioni e risposte dal mercato.

*The newest production facility of Sirman, dedicated to the production of vacuum pack machines. This product further expands Sirman line achieving outstanding results in customer satisfaction.*



### PIAZZOLA 1

Dedicato alla produzione di macchine per la preparazione dinamica in cucina, quali pelapatate, tagliaverdure e pulisciozze. Un reparto di soli 1.000 mq che sforna grandi numeri grazie alla sua focalizzazione sui prodotti che hanno introdotto Sirman nelle cucine di tutto il mondo.

*Dedicated to the production of food preparation machines such as potato peelers and continuous-feed food processors. An area of just 1.000 m<sup>2</sup> with an extremely high production yield focusing on products which have made Sirman a renowned name inside the professional kitchens all over the world.*



### PIAZZOLA 2

Ben strutturato ed efficiente il reparto di produzione macchine lavorazione carni conta su 2.200 mq di spazio, dove 5 isole di assemblaggio sfornano macchine dalle grandi prestazioni, ponendo particolare attenzione alle esigenze dei singoli mercati e, spesso, anche dei singoli clienti. Una struttura dove i numeri lasciano lo spazio ad una maggiore attenzione alle specificità richieste per questa tipologia di prodotto, dove affidabilità, performance e resistenza agli ambienti più duri, sono diventate le linee guida per lo sviluppo di sempre nuovi prodotti e soluzioni.

*The highly efficient facility of 2.200 m<sup>2</sup> destined to the production of meat processing machines features 5 assembly areas capable of producing high-performance machines in accordance to the particular needs of a marketplace or even a single account. Accuracy and care prevail over yield for the development and implementation of dependable, performing and durable products and solutions.*

Showroom



Corsi di aggiornamento - Seminars



Fiere - Exhibitions



Sirman è sempre al passo con i tempi, con le nuove tendenze ristorative, con le più innovative tecnologie e, soprattutto, con le esigenze dei migliori professionisti della cucina. Per essere sempre aggiornata e offrire soluzioni in piena sintonia con un mercato in continua evoluzione, l'azienda investe ogni anno molte risorse nella formazione del suo team e nella comunicazione a 360° del mondo Sirman, per raccontarne tutte le sue numerose e importanti sfaccettature. L'azienda, infatti, crede fortemente nell'importanza di far conoscere la qualità dei propri prodotti perché solo in questo modo i suoi clienti possono comprendere i vantaggi che i nuovi sistemi portano al lavoro di tutti i giorni per sfruttarne al massimo le potenzialità ed esprimere al meglio la qualità del loro lavoro. Perché è proprio la qualità del lavoro di chi opera in cucina da professionista che Sirman vuole valorizzare e promuovere con tutti i mezzi a sua disposizione: con la sponsorizzazione di eventi di successo che vedono come protagonista la Nazionale Italiana Cuochi e brillanti rappresentanti del mondo del 'cooking and beverage', con un ampio ventaglio di corsi e seminari di formazione tenuti da tecnici del settore, con importanti opere nell'ambito dell'editoria come la pubblicazione di ricettari di chef rinomati, materiali multimediali e con la rivista Zafferano magazine, dedicata interamente ai Professionisti della ristorazione e della gastronomia con articoli e approfondimenti curati dai maggiori esperti del settore.

*Sirman stays updated with the new food service trends, the most innovative technologies and the demands of the finest Chefs. To do so and provide solutions to an ever changing market place, Sirman values training and development of the Workforce and a comprehensive corporate communication to emphasize a considerable amount of important activities. It is extremely important indeed to acknowledge the quality of the products as it is the only way for Customers to understand the daily advantages of new solutions and fully express skills and abilities. Sirman intends to promote the quality work of Professionals by means of event sponsorships for the Italian culinary team and famous personalities of the culinary world, classes and seminars conducted by industry Experts, publications of recipe books from world-renowned Master Chefs, multimedia and the Zafferano magazine, entirely dedicated to the food service and culinary Professionals with insights from the finest culinary experts.*



Web Site



Magazine di ristorazione e gastronomia  
Magazine of catering and gastronomy



Pubblicazioni specializzate - Literature

Sponsor ufficiale di:



Materiale multimediale - Multimedia support

# TECHNOLOGY

## SIRMANTRACK [www.sirmantrack.com](http://www.sirmantrack.com)

E' una piattaforma integrata tra ambiente web e mobile che permette di gestire il post vendita di un parco macchine installato.

Velocizza le chiamate di servizio, tramite invio automatici di SMS ai tecnici, agevola la stesura dei rapportini di riparazione, traccia tutti gli interventi e i relativi costi di ogni macchina sottoposta a controllo. Un grande aiuto per chi, come Sirman, fa dell'assistenza il suo punto di forza.

*Sirman takes the after-sale service to the next level of customer satisfaction thanks to the innovative Sirmantrack, a web-based platform integrated with web and mobile.*

*Easier management of service calls through SMS text messages and service bulletin-filling process, keeping track of all calls and costs for each unit.*

*A great help for those, like Sirman, who make the after-sale service their strength.*

## SIRMANRCS Remote Control System

Il telecontrollo, tecnologia dedicata normalmente agli impianti industriali o a situazioni che devono gestire contenuti di grandi valore, entra grazie a Sirman, anche negli apparecchi per il food processing.

Il software proprietario e la tecnologia hardware adottata in esclusiva da Sirman permettono, con costi decisamente contenuti, di avere sotto controllo sempre e in ogni momento un parco macchine installato, con evidenti vantaggi nella gestione economica ed energetica.

*Usually employed for industrial equipment and critical business activities, the remote control technology now enters the food processing equipment industry as well thanks to Sirman. With a proprietary software, an exclusive hardware and minimum costs, SirmanRCS allows for the complete control of a installed set of equipment with significant management and energy-saving advantages.*







# ONLY FOR PROFESSIONALS





# FACTORY





Tutto il processo produttivo avviene all'interno dell'azienda. Anche gli ultimi investimenti realizzati dimostrano quanto Sirman punti sulla produzione interna più che sulla dislocazione della produzione nel Far East. Già nel 2008 sono entrati in funzione il nuovo magazzino spedizioni con 9 baie di carico e il reparto di controllo qualità con 7 nastri trasportatori dove vengono preparate e testate le macchine prima dell'imballaggio e spedizione. Il 2017 ha visto partire l'ottavo centro di lavoro automatico doppia tavola e il nuovo sistema di pulitura robotizzata con 2 antropomorfi che assorbono il 98% di un lavoro duro e impegnativo. Ma, ulteriore passo in avanti dell'azienda verso una migliore organizzazione del lavoro e una maggiore efficienza, è il nuovo magazzino robotizzato, a servizio della produzione e con capienza di 2650 pallet, totalmente integrato con il sistema ERP aziendale e che distribuisce i componenti alle varie isole di assemblaggio: un sistema unico nel settore per velocizzare e rendere ancora più flessibile la produzione interna. Tutti investimenti importanti, questi, destinati a strutturare e ottimizzare il sistema produttivo.

*The entire manufacturing process is developed in our factories. The latest investment activities indeed contribute to a lean and effective production system and do not give rise to outsourcing of production to the Far East.*

*Since 2008 a new shipping and receiving department has been fully operative with 9 loading docks and 7 power and QC test stations powered by conveyor belts to better coordinate and speed up the equipment packaging process.*

*In 2017 it was the turn of the 8th automatic work center and the new robotic polishing system for polishing off the parting lines of components without the labor intensive efforts required with manual systems.*

*A further step ahead of Sirman has been the automatic storage and retrieval system integrated with the company ERP and capable of 2650 pallets to ensure availability of material at each stage of the production process, thus avoiding bottlenecks and enhancing efficiency.*





Grazie alla sua brillante équipe tecnica, alle dieci unità produttive supportate da un'affidabile rete di subfornitori e ad un rigoroso sistema di collaudo, l'azienda controlla direttamente ogni fase, dalla progettazione alla realizzazione, dalla lavorazione della lamiera per passare alla modellazione dei singoli pezzi e al montaggio degli stessi, fino ai test di controllo di validità del prodotto e alla consegna del prodotto finito. Un processo complesso che mette in gioco forza lavorativa, conoscenze specialistiche di settore, grande precisione nel portare a termine ogni step dell'intera catena produttiva e un lavoro di team molto articolato e strutturato per garantire la massima organizzazione ed elevati standard di qualità su tutti i suoi prodotti marchiati Sirman.

*A talented engineering department, ten production facilities backed by a reliable supply chain and a rigorous test system enable Sirman to control each production stage from planning to implementation: from material machining to the assembly process up to the quality control and delivery of the end product to the Customer. That's a challenging process involving a specialized workforce, skills and accuracy in conjunction with an interdependent teamwork to ensure the highest quality standards and gain the necessary competitive advantage.*





# INDICE

## 16 AFFETTATRICI

*slicing machines*

- 24 Anniversario 300
- 26 Anniversario LX 350
- 26 Canova
- 33 Canova Automec
- 41 Galileo Evo
- 44 Galileo Evo Power
- 46 Giotto
- 52 Leonardo Evo
- 48 Mantegna
- 31 Mirra
- 45 Mirra Verticale
- 34 Palladio
- 36 Palladio Automec
- 37 Palladio Evo Usa
- 40 Palladio/Galileo Stonehenge
- 38 Raffaello Evo
- 28 Smart
- 50 Tiziano Evo
- 30 Topaz

## 56 RISTORAZIONE

*food processors*

- 78 Athos
- 73 Blitz
- 80 Ciclone
- 101 Caneva
- 68 Como
- 59 Concerto 5
- 74 Cutter
- 98 Dolomiti
- 76 C-Tronic
- 89 GF Dakota
- 90 GFX - GF
- 88 GF Vegas - GF Denver
- 87 GP-GF
- 67 i2Pasta
- 84 PPJ - LCJ
- 62 Orchestra 10
- 84 PPJ - LCJ SC
- 69 Sansone
- 66 Raviomatic
- 58 Sinfonia 2
- 64 Sirpasta Maxi
- 60 Sirpasta XP
- 79 Storm
- 97 TC 12-22 Dakota
- 95 TC 12E-22E
- 92 TC 8 Vegas - TC 12 Denver
- 91 TCG 12-22 Dakota

- 93 TCG 12E-22E
- 96 TCG 8 Vegas - TCG 12 Denver
- 70 TM2
- 72 TM-TG
- 80 Vortex

## 102 lavorazione CARNE

*meat processors*

- 145 Ceppi-Tavoli-Piani
- 140 Drake
- 141 Drake Man
- 121 Format
- 122 Katana 6-12-20
- 118 Master
- 132 IDRA 15-25-35-50
- 124 IP 10-20 M
- 125 IP 30-50 M Y14
- 127 IP 50-80-120-180 XP BA
- 129 IS 8-16 X - IS 12 VX
- 130 IS 8-16 Aries
- 131 IS 16-30-50 Idr. Oriz.
- 144 SA
- 134 SO Alluminio
- 135 SO Bremen
- 136 SO Inox
- 138 Sterilizzatori elettrico e a liquido
- 139 Sterilizzatori UV
- 108 TC 22-32 Barcellona
- 109 TC 22-32 Barcellona ICE
- 106 TC 22-32 Colorado
- 111 TC 22-32 Nevada
- 112 TC 22-32 Nevada ICE
- 107 TC 32 California
- 114 TC 32 Buffalo
- 116 TC 32-42 Montana
- 142 T-Rex / T-Rex Automec

## 146 macchine IMBALLAGGIO

*packaging machines*

- 149 Dispenser
- 150 Easyvac
- 148 Sigix M20
- 157 Vacuex
- 152 W8 30-40-50-70

## 158 macchine COTTURA

*cooking machines*

- 169 Aliseo
- 170 Basic - Pro
- 160 Easysoft
- 171 P.I. 2,5 - 3,5
- 162 Softcooker S
- 166 Softcooker Wi-Food
- 164 Softcooker SR Wi-Food
- 165 Softcooker SR BI Wi-Food
- 168 Softcooker Y09

## 172 SNACK e PIZZA

*snack and pizza*

- 182 4Q - 6Q - 12Q
- 175 Cort
- 180 Cort V. - PD V. - Top V.
- 179 Crepiera Tonda
- 174 Elio
- 189 Cube
- 204 Forno pizza
- 193 GW
- 196 Hercules 5-10-15
- 198 Hercules 20-30-40-50
- 194 Hot dog - Roberto
- 191 Night & Day
- 176 PD
- 177 PD Power
- 177 PD VC
- 202 Piastre scaldapizza
- 213 Pizza
- 200 P-Roll
- 185 Roller
- 205 Stromboli
- 178 TOP
- 184 Tosti
- 183 Tostone
- 195 TW
- 207 Vesuvio
- 203 Vetrinette D. 38-42
- 186 Vista
- 187 Vista Bold
- 192 Vista Easycold
- 188 Vista Tower
- 206 Vulcano

## 214 linea BAR

*bar line*

- 224 Apollo
- 222 Barmaster
- 218 Dragone
- 231 Ice spaghetti/Spremiagrumi manuale
- 225 Mercurio
- 228 Modulo
- 230 Multiplo
- 227 Nordkapp
- 220 Orione
- 219 Saturno
- 216 Sirio
- 226 Triton

## 232 distribuzione ESCLUSIVA

*exclusive distribution*

- 251 45K
- 270 BBQ X3 - X4
- 268 Carrelli / Trolley
- 264 Ektor 37
- 258 Eldorado
- 263 Forcella
- 252 HW 45
- 240 IH 27 - IH 35 - IH 35 Wok - PI 5.0 Kw
- 260 Klondike
- 262 Minicooker - Mycook
- 237 Minneapolis 5
- 236 Minneapolis 10-20-30-40
- 254 Ortolina
- 241 PB 1/1 Inox
- 238 Pacojet
- 261 Pastì
- 256 Plutone 7-10-20-30
- 253 S 300/2 - S 400/2 - S 400/2T
- 266 Salento-Soave-Monferrato-Colli Orientali
- 271 SAR-C 447E
- 234 Scharfen
- 255 SmokerBag - Tegi

### **Panasonic**

- 245 1/1 Gastronorm
- 246 1/2 Gastronorm
- 244 NE 1027-1037-1037 Self
- 248 NE C1475
- 243 NN CF771 S
- 242 SR-UH36N

### **Minneapolis**

- 250 WDB 900 COMBI - WP 1000PF - CM1039A

### **Samsung**

- 273 DV 431 AEP
- 272 WF 431 ABP

## AFFETTATRICI

Da sempre prodotto di punta della proposta Sirman, le affettatrici, progettate dalla professionalità e competenza di un Ufficio Tecnico all'avanguardia, sono disponibili in una gamma di rara completezza.

A caratterizzare gli innumerevoli e differenti modelli lanciati sul mercato sono i materiali altamente selezionati usati per realizzarli, una funzionalità ad altissima tecnologia, una totale affidabilità in fatto di pulizia e sicurezza - garantita dalla piena fedeltà alle più rigorose norme di sicurezza elettromeccanica e alimentari - e, non da ultimo, un design capace di unire classico e moderno in un'inimitabile armonia di linee e forme.

In continua evoluzione per soddisfare le specifiche esigenze di tutti i settori, le affettatrici firmate Sirman costituiscono oramai un fondamentale punto di riferimento nel mercato internazionale del food processing.

## SLICING MACHINES

*Slicing machines have always been one of Sirman's front-line products, fine-adjusted by the professional expertise and competence of an avant-garde Technical Office, and available in a remarkably varied range.*

*The great variety of different models launched on the market is characterized by the carefully-selected materials used in their making, by a practicality stemming from a very high technological content, and from a total reliability as regards cleaning and safety - guaranteed by full compliance with the strictest standards relating to food processing - and, last but not least, a design capable of combining classic and modern in an inimitable harmony of lines and forms.*

*In constant evolution to satisfy the specific needs of all sectors, the Sirman slicing machines have become a fundamental reference on the international food processing market.*





# CARATTERISTICHE COMUNI A TUTTE LE AFFETTATRICI

## SPECIFICHE AFFETTATRICI COMMON FEATURES IN ALL SLICERS

### 1. Finitura di lucidatura e anodizzazione

Igienica e duratura nel tempo

### 2. Lame forgiate e temprate a forte spessore

Massima tenuta del filo e facile affilatura

### 3. Affilatoio incorporato dalla 220 A.I. in sù in fusione, con doppio smeriglio.

Praticità e precisione nell'affilatura.

### 4. Trasmissione con robusta cinghia poliV

Massima affidabilità, silenziosità e facile manutenzione

### 5. Motori asincroni a sei poli

Forza, robustezza e silenziosità

### 1. Fine polishing an anodizing treatment

Hygienic and long lasting

### 2. Forged, hardened large thickness blades

Long lasting and easy to sharpen cutting edge

### 3. Cast-in sharpener assembly is standard for all slicers bigger than 220 A.I.

Easy and precise sharpening

### 4. Reliable poliV belt drive

Great reliability, silent running and easy servicing

### 5. Asynchronous 6 poles motors

Strong, reliable and silent running

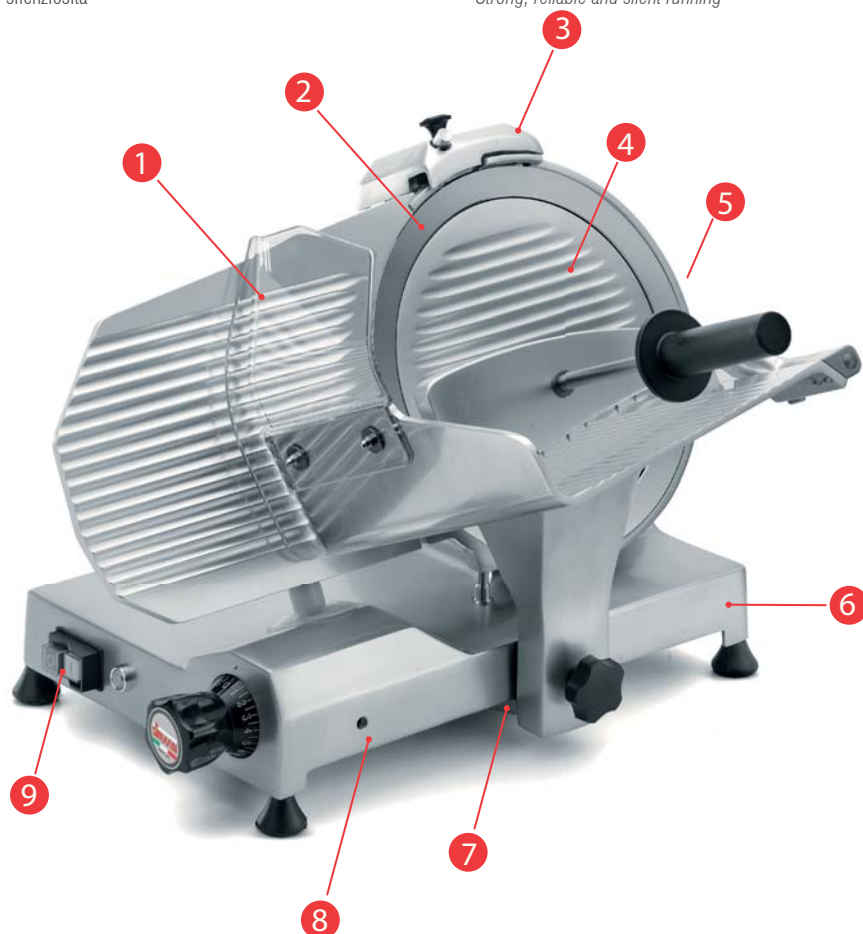

### 6. Realizzate in fusione di lega di alluminio PERALUMAN

Robustezza elasticità ed insonorizzazione

### 7. Scorrimento carrello su boccole autolubrificanti

Garanzia di massima scorrevolezza nel tempo

### 8. Versioni CE professionale

Carro rimovibile con interblocco vela

Sicurezza e praticità in fase di pulizia

### 9. Versioni CE professionale

Comandi IP 44 (o 54 o 67) con dispositivo NVR (No Volt Release)

Sicurezza in caso di mancanza di tensione

### 6. Made of PERALUMAN cast aluminium alloy

Strong, reliable and silent running

### 7. Carriage running on self-lubricating bushes

Long lasting sliding performances

### 8. CE Professional slicers

Removable carriage and thickness gauge blocking device

Easy and safe to clean

### 9. CE Professional slicers

IP 44 (54, 67) switches and NVR (No Volt Release) device

Safety device against accidental switching on

AMBIENTE DI UTILIZZO														
SMART - TOPAZ	Green	Green	Green	Grey	Grey	Grey	Grey	Grey	Grey	Grey	Grey	Grey	Grey	Grey
MIRRA	Green	Green	Green	Green	Green	Green	Grey	Grey	Grey	Grey	Grey	Grey	Grey	Grey
CANOVA	Grey	Green	Green	Green	Green	Green	Green	Grey	Grey	Grey	Grey	Grey	Grey	Grey
PALLADIO/RAFFAELLO	Grey	Grey	Grey	Grey	Grey	Green	Green	Green	Green	Green	Grey	Grey	Grey	Grey
GALILEO	Grey	Grey	Grey	Grey	Grey	Green	Green	Green	Green	Green	Green	Green	Green	Green
GALILEO INGRANAGGI	Grey	Grey	Grey	Grey	Grey	Green	Green	Green	Green	Green	Green	Green	Green	Green
GALILEO AUT	Grey	Grey	Grey	Grey	Grey	Green	Green	Green	Green	Green	Green	Green	Green	Green
MIRRA VERTICALE	Green	Green	Green	Grey	Green	Green	Green	Grey	Grey	Grey	Grey	Grey	Grey	Grey
GIOTTO	Green	Green	Green	Green	Green	Green	Green	Grey	Grey	Grey	Grey	Grey	Grey	Grey
MANTEGNA/TIZIANO	Grey	Grey	Grey	Green	Green	Green	Green	Green	Green	Green	Green	Green	Green	Green
LEONARDO	Grey	Grey	Grey	Green	Green	Green	Green	Green	Green	Green	Green	Green	Green	Green

PRODOTTO												
SMART - TOPAZ	Yellow	Yellow	Green	Green	Green	Yellow	Red	Yellow	Green	Red	Yellow	Yellow
MIRRA	Yellow	Yellow	Green	Green	Green	Yellow	Yellow	Yellow	Green	Red	Yellow	Yellow
MIRRA 300	Yellow	Yellow	Green	Green	Green	Yellow	Yellow	Yellow	Green	Red	Yellow	Yellow
CANOVA	Yellow	Yellow	Green	Green	Green	Yellow	Yellow	Yellow	Green	Green	Yellow	Yellow
PALLADIO / RAFFAELLO EVO	Yellow	Yellow	Green	Green	Green	Yellow	Yellow	Yellow	Green	Green	Yellow	Yellow
GALILEO EVO / INGR.	Yellow	Yellow	Green	Green	Green	Yellow	Yellow	Yellow	Green	Green	Yellow	Yellow
GALILEO EVO AUT	Yellow	Yellow	Green	Green	Green	Yellow	Yellow	Yellow	Green	Green	Yellow	Yellow
MIRRA VERTICALE	Yellow	Yellow	Green	Green	Green	Yellow	Yellow	Yellow	Green	Red	Yellow	Yellow
GIOTTO BS	Yellow	Yellow	Green	Green	Green	Yellow	Yellow	Yellow	Green	Red	Yellow	Yellow
GIOTTO VCS	Yellow	Yellow	Green	Green	Green	Yellow	Red	Yellow	Green	Red	Yellow	Yellow
MANTEGNA - TIZIANO EVO BS	Yellow	Yellow	Green	Green	Green	Yellow	Yellow	Yellow	Green	Green	Yellow	Yellow
MANTEGNA - TIZIANO EVO VCS	Yellow	Yellow	Green	Green	Green	Yellow	Red	Yellow	Green	Green	Yellow	Yellow
LEONARDO EVO BS	Yellow	Yellow	Green	Green	Green	Yellow	Yellow	Yellow	Green	Green	Yellow	Yellow
LEONARDO EVO VCS	Yellow	Yellow	Green	Green	Green	Yellow	Red	Yellow	Green	Green	Yellow	Yellow

TIPO DI LAMA												
Standard cromata	Yellow	Yellow	Green	Green	Green	Green	Green	Green	Green	Green	Green	Green
Standard teflonata	Yellow	Green	Yellow	Yellow	Yellow	Yellow	Yellow	Yellow	Yellow	Yellow	Yellow	Green
Dentata cromata	Green	Green	Red	Yellow	Red	Red	Red	Red	Yellow	Green	Yellow	Yellow

- Consigliata per l'uso  
*Suggested for this use*
- Utilizzabile ma non ideale  
*Usable for this food but not ideal*
- Sconsigliata  
*Not recommended for this use*

# VERSIONI AFFETTATRICI

## SLICERS VERSIONS

### AFFETTATRICI BASIC



1. Protezione inferiore  
*Bottom shield*

### AFFETTATRICI € DOMESTICO



1. Paramano piatto in plexiglass  
*Plexiglass hand guard*  
2. Elsa su manopola pressamerce  
*Hilt on product pusher handle*  
3. Microinterruttore su paralama  
*Microswitch on blade cover*  
4. Protezione inferiore  
*Bottom shield*

### AFFETTATRICI € PROFESSIONALE



1. Paramano piatto in plexiglass  
*Plexiglass hand guard*  
2. Elsa su manopola pressamerce  
*Hilt on product pusher handle*

3. Microinterruttore su paralama (escluso affettatrice Ingranaggi)  
*Microswitch on blade cover (Not available on Ingranaggi series slicers)*  
4. Comandi con NVR  
*NVR controls*

5. Anello protezione lama  
*Blade protection ring*  
6. Estrattore per lama  
*Blade Removal Tool (BRT)*

7. Meccanismo sgancio piatto affettatrice  
*Carriage interlock on open gauge*  
8. Protezione inferiore  
*Bottom shield*

## COMANDI CONTROLS



**Interruttore standard - isolato IP44**  
Affettatrici Basic e affettatrici UL

*Standard switch - protection class IP44*  
*Slicers Basic and slicers UL*



**Interruttore rotativo UL - isolato IP42**  
Affettatrici Basic con lama 300 o maggiore

*Rotative switch UL - protection class IP42*  
*Slicers Basic with blade 300 or bigger*



**Interruttore CE professionale - isolato IP44**  
Affettatrici Smart, Mirra 220-300, Mirra Vert. 275-300, Canova e Giotto

*CE Professional switch - protection class IP44*  
*Slicers Smart, Mirra 220-300, Mirra Vert. 275-300, Canova and Giotto*



**Pulsantiera Opera - isolata IP54 (pulsanti IP67)**  
Affettatrici CE Palladio, Raffaello Evo, Galileo Evo, Mantegna, Tiziano Evo e Leonardo Evo

*Opera electronic switch - protection class IP54*  
*(push-buttons IP67)*  
*CE slicers Palladio, Raffaello Evo, Galileo Evo, Mantegna, Tiziano Evo e Leonardo Evo*



**Pulsantiera Sidney -isolata IP54 (pulsanti IP67)**  
Affettatrice CE Canova Top e Giotto Top

*Sidney electronic switch - protection class IP54*  
*(push-buttons IP67)*  
*Slicer CE Canova Top and Giotto Top*



**Comandi su carcassa (pulsanti IP67)**  
Affettatrici CE Palladio Top, Raffaello Evo Top, Galileo Evo Top, Mantegna Top, Tiziano Evo Top e Leonardo Evo Top

*Controls on body (push-buttons IP67)*  
*CE slicers Palladio Top, Raffaello Evo Top, Galileo Evo Top, Mantegna Top, Tiziano Evo Top e Leonardo Evo Top*



**Pulsantiera Sirman - isolata IP54**  
su richiesta

*Sirman push-button panel - protection class IP54*  
*on request*

## VERSIONI SPECIALI SPECIAL VERSIONS



Paramano piatto in plexiglass  
*Plexiglass hand guard*



Interruttore rotativo  
*Rotative switch*



Protezione inferiore  
*Bottom shield*

# BS1 - BS2 - BS3 PER AFFETTATRICI VERTICALI SALUMI

## BS1 - BS2 - BS3 COLD CUT VERTICAL SLICERS



### BS

- Leva sblocco standard
- Braccio stringisalumi con staffa fissa in alluminio e chiodi inox
- Mirra 250 - 275 - 300 Vert. BS
- *Quick release mechanism*
- *Clamping arm features a fixed aluminum product pusher with s/steel nails*
- *Mirra 250 - 275 - 300 Vert. BS*



### BS1

- Leva sblocco standard
- Braccio stringisalumi con staffa chiodata in acciaio inox, facilmente smontabile
- Giotto - Mantegna - Tiziano Evo - Leonardo Evo
- *Quick release mechanism*
- *Clamping arm features a s/steel spiked product pusher that easily removes*
- *Giotto - Mantegna - Tiziano Evo - Leonardo Evo*



### BS2

- Leva sblocco ergonomica
- Braccio stringisalumi con staffa chiodata di grandi dimensioni in acciaio inox, basculante, facilmente smontabile
- Sistema integrato che allontana automaticamente la staffa dalla vela, quando viene alzata
- Leonardo Evo Top
- *Improved, ergonomic quick release mechanism*
- *Clamping arm features a full-size, shape-adaptive, s/steel spiked product pusher that easily removes*
- *During product loading/unloading, clamping arm outer motion securely away from gauge sharpener and blade ring*
- *Leonardo Evo Top*



### BS3

- Leva sblocco ergonomica
- Braccio stringisalumi con staffa chiodata di grandi dimensioni in acciaio inox, basculante, facilmente smontabile
- Sistema integrato che allontana automaticamente la staffa dalla vela, quando viene alzata
- Braccio stagno anche per lavaggio con acqua (escluso lavastoviglie, idropulitrice, immersione)
- Leonardo Evo GDO
- *Improved, ergonomic quick release mechanism*
- *Clamping arm features a full-size, shape-adaptive, s/steel spiked product pusher that easily removes*
- *During product loading/unloading, clamping arm outer motion securely away from gauge sharpener and blade ring*
- *Water-resistant, double-sealed clamping arm (except dishwasher, pressure washer, immersion)*
- *Leonardo Evo GDO*







## ANNIVERSARIO 300



- Fusione in alluminio smaltata.
- Particolari in acciaio inox e alluminio anodizzato argento.
- Lama 300.
- Sistema brevettato di movimentazione (senza componenti meccanici in vista).
- Braccio blocca salumi BS1.
- Pressamerce smontabile in acciaio inox.
- Facile posizionamento del piatto scorrevole.
- Ergonomia, scorrevolezza e praticità di pulizia.
- Carro completamente smontabile per la pulizia.

- Polished and painted aluminum construction.
- Featuring stainless steel and silver anodized aluminum details.
- 300 mm (12") blade Flywheel slicer.
- Patented motion system with no visible mechanical parts.
- Table featuring a lateral movement with a double articulating arm BS1 to firmly hold and smoothly slide the produce through.
- Stainless steel removable remnant holder.
- Simple, yet stylish Italian design, rounded for ease of cleaning.
- Easy to clean and disassemble without tools.
- Easy to clean and disassemble without tools.



Facile da smontare e pulire  
Easy to disassemble and clean



## XL 300



Piedistallo opzionale - disponibile nero o rosso  
Optional stand - red or black available

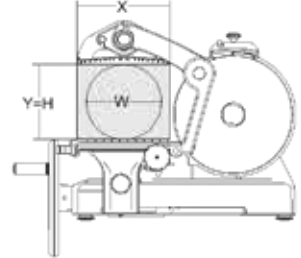
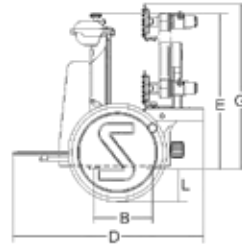
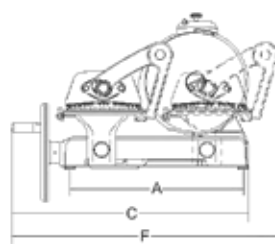

					A	B	C	D	E	F	G	L	X	Y	H	W			
	mm-inch	mm	mm	mm	mm	mm	mm	mm	mm	mm	mm	mm	mm	mm	mm	mm	kg	mm	kg
<b>Anniversario 300</b>	300x12"	3	255	270x295	520	150	770	625	510	855	580	90	270	200	200	200	60	900x620x650	78
<b>XL 300</b>	300x12"	3	255	270x295	520	150	770	625	510	855	580	90	270	200	200	200	60	900x620x650	78



# ANNIVERSARIO LX 350



- Un connubio di eleganza classica e funzionalità moderna.
- Sapiente fusione di stile ed ergonomia, praticità e buon gusto, funzionalità ed esclusività.
- Una poesia di linee, luci, colori e meccanica, la più pura, semplice, funzionale.
- Costruzione in fusione di ghisa sferoidale.
- Particolari in alluminio anodizzato argento.
- Braccio speciale stringisalumi BS2.
- Pressamerce smontabile in acciaio inox.
- Carro smontabile per la pulizia.

- *A perfect mix of classical elegance with modern functionality.*
- *Fusion of style and ergonomics, easy use and good taste, practical and exclusive.*
- *A poem of lines, lights, colours and technics, pure, simple and durable technics.*
- *Solid cast iron construction eposidic painted.*
- *Carriage and other details made of anodized aluminium alloy.*
- *BS2 self adjusting blocking arm.*
- *Stainless steel removable remnant holder.*
- *Carriage easy to remove.*



Colori opzionali:  
Optional colors:

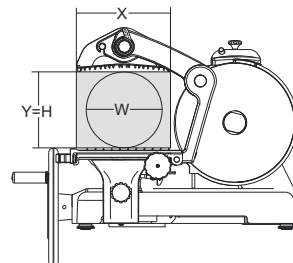
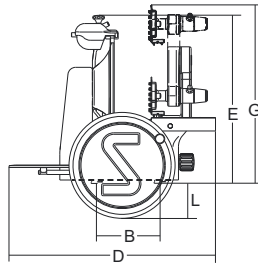
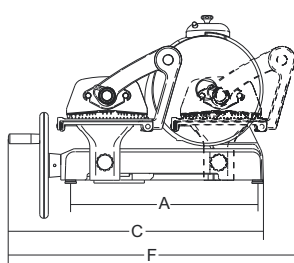

	mm-inch	mm	mm	mm	mm	mm	mm	mm	mm	mm	mm	mm	mm	mm	mm	kg	mm	kg	
<b>LX 350</b>	350/14"	3	345	320x350	592	180	820	780	560	910	615	120	330	255	255	255	72	960x920x860	90



Braccio speciale stringisalumi BS2  
BS2 self adjusting blocking arm



Ampio spazio tra lama e corpo  
More space between blade and body machine



Protezione lama rimovibile  
Removable blade protection

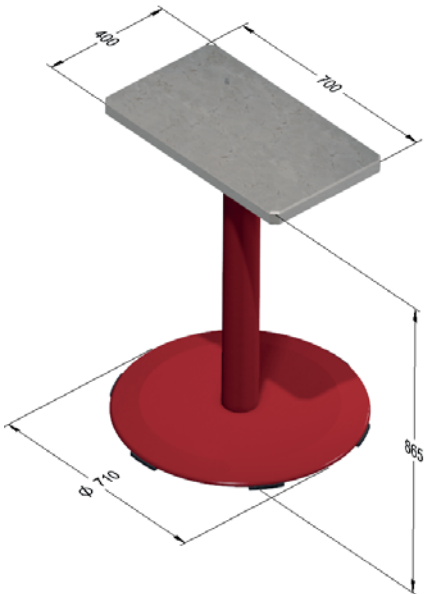

Piedistallo opzionale con piano in marmo  
Optional stand with marble surface



Piano in vetro di serie  
Standard glass surface

Opzionali  
Optionals



Piano bianco White 2141  
White 2141 surface



Piano sabbia Sand. V. 2300  
Sand-Coloured V. 2300 surface



Piano in marmo di Carrara  
White marble surface Carrara



Piano Starlight White  
White Starlight surface



# SMART

- Basamento in pressofusione con finitura in smalto alimentare.
- Vela, piatto e coprilama in alluminio anodizzato.
- Pressamerce ergonomico in alluminio pressofuso, con denti conformati per bloccare perfettamente il prodotto da tagliare.
- Ampio spazio tra motore e lama per un'agevole pulizia.
- Motore ventilato a servizio continuo.
- Scorrimento carrello su boccole autolubrificanti e perni lappati.
- Affilatoio incorporato con corpo in fusione e doppio smeriglio di serie.
- Dimensioni compatte ma con grande capacità di taglio.
- Versione CE Professionale con sblocco su carro.
- Inclinazione lama 25°

- *Painted aluminium body.*
- *Anodized aluminium components.*
- *Ergonomic food-presser made of die-cast aluminium with teeth shaped to best block the product to cut.*
- *Great distance between blade and motor for easy cleaning.*
- *Ventilated motor for continuous work.*
- *Carriage running on self-lubricating bushes and lapped pins.*
- *Cast-in body sharpener assembly with 2 standard emery-wheels.*
- *Compact dimensions but great cutting capacity.*
- *Device for releasing the carriage on CE version.*
- *25° blade inclination*



Colori opzionali:  
Optional colors:

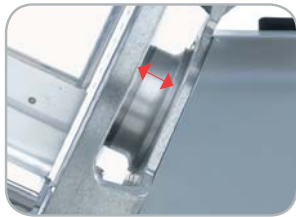
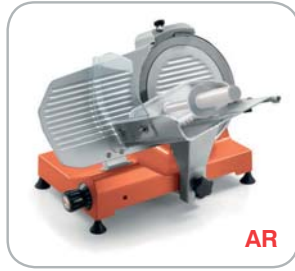

Ampio spazio tra lama e corpo macchina  
More space between blade and body machine



Spazioso piano per appoggio prodotto  
Large tray

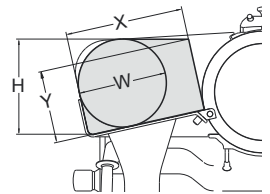
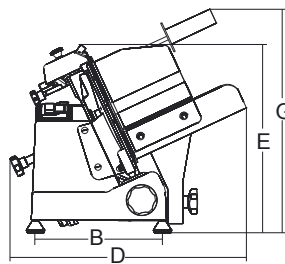
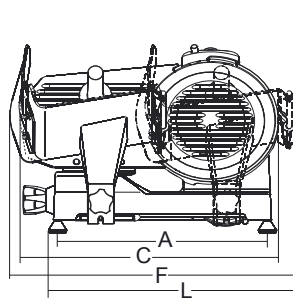

						<b>A</b>	<b>B</b>	<b>C</b>	<b>D</b>	<b>E</b>	<b>F</b>	<b>G</b>	<b>L</b>	<b>X</b>	<b>Y</b>	<b>H</b>	<b>W</b>			
	mm-inch	watt-Hp	mm	mm	mm	mm	mm	mm	mm	mm	mm	mm	mm	mm	mm	mm	mm	kg	mm	kg
<b>Smart 220</b>	220/9"	132/0,18	13	247	225x240	405	245	480	460	365	555	466	495	220	135	170	160	15	600x500x420	17
<b>Smart 250</b>	250/10"	132/0,18	13	247	225x240	405	245	500	460	365	555	460	480	215	150	185	175	15,5	600x500x420	18



# TOPAZ

- Fusione in lega di alluminio anodizzato.
  - Basamento piano per una facile pulizia.
  - Silenzioso e robusto motore asincrono.
  - Trasmissione con robusta cinghia poliV.
  - Lama forgiata e temprata a forte spessore.
  - Scorrimento carrello su boccole autolubrificanti.
  - Affilatoio incorporato in fusione con doppio smeriglio di serie dal modello 220 A.I. in su.
  - Disponibili lame teflonate o dentate.
  - Inclinazione lama 25°.
- Anodized cast aluminum alloy.
  - Flat base for easy cleaning.
  - Strong and silent-running asynchronous motor.
  - Reliable poliV belt drive.
  - Forged, hardened large thickness blades.
  - Carriage running on self-lubricating bushes.
  - Cast-in sharpener is standard for all models bigger than 220 A.I.
  - Teflon coated or toothed blades are available on demand.
  - 25° blade inclination.



TOPAZ 250-275



Paramano  
Hand guard



Protezione inferiore  
Bottom shield



Affilatoio incorporato 195-220  
Without built-in sharpener 195-220

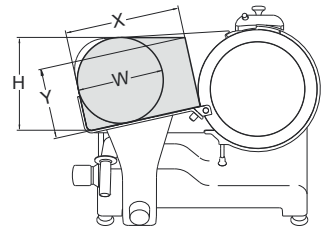
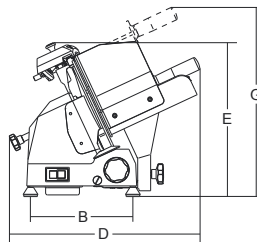
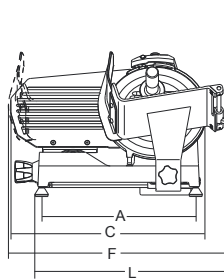

						A	B	C	D	E	F	G	L	X	Y	H	W			
	mm-inch	watt-Hp	mm	mm	mm	mm	mm	mm	mm	mm	mm	mm	mm	mm	mm	mm	mm	kg	mm	kg
<b>Topaz 195</b>	195/8"	110/0,15	13	162	185x165	310	220	375	355	300	385	360	370	140	110	135	120	10,5	430x400x370	12
<b>Topaz 220</b>	220/9"	145/0,20	13	245	200x220	380	250	440	410	330	550	400	450	200	130	145	140	13	600x500x420	15
<b>Topaz 220 A.I.</b>	220/9"	145/0,20	13	245	200x220	380	250	440	410	350	550	400	450	200	140	160	155	13,5	600x500x420	15,5
<b>Topaz 250C</b>	250/10"	145/0,20	13	240	230x230	380	250	480	410	360	500	410	475	185	165	180	180	14	600x500x420	16
<b>Topaz 250</b>	250/10"	145/0,20	13	235	220x225	412	255	480	410	360	515	455	505	210	170	190	180	15,5	600x500x420	17,5
<b>Topaz 275</b>	275/11"	145/0,20	13	235	220x225	412	255	520	410	370	525	455	505	200	190	205	205	16,5	600x500x500	19



Topaz 195 - 220



Topaz 220 A.I. - 250

# MIRRA



MIRRA 300 Y09

- Fusione in lega di alluminio anodizzato.
- Ampio spazio tra motore e lama per un'agevole pulizia.
- Motore ventilato.
- Lama forgiata e temprata a forte spessore.
- Scorrimento carrello su boccole autolubrificanti e perni lappati.
- Viteria e parafetta in acciaio inox.
- Robusto supporto vela.
- Affilatoio incorporato con corpo in fusione e doppio smeriglio di serie.
- Dimensioni compatte ma con grande capacità di taglio.
- Versione CE Professionale con sblocco su carro.
- Disponibili lame teflonate o dentate.
- Inclinazione lama 25°.

- Anodized cast aluminum alloy.
- Great distance between blade and motor for easy cleaning.
- Ventilated motor.
- Forged, hardened large thickness blades.
- Carriage running on self-lubricating bushes and lapped pins.
- Stainless steel screws and slice deflector.
- Strong thickness gauge support.
- Cast-in body sharpener assembly with 2 standard emery-wheels.
- Compact dimensions but great cutting capacity.
- Device for releasing the carriage on CE version.
- Teflon coated or toothed blades are available on demand.
- 25° blade inclination.



Parafetta tondo rimovibile su mod. 250 opzionale  
Removable round slicer deflector on mod. 250 optional



Ampio spazio tra lama e corpo macchina  
More space between blade and body machine



Protezione paracqua su puleggia di serie  
Enclosed and sealed belt pulley standard

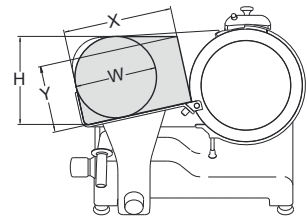
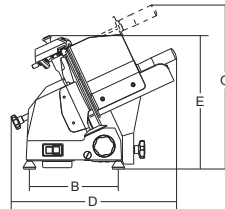
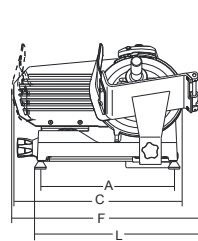

						<b>A</b>	<b>B</b>	<b>C</b>	<b>D</b>	<b>E</b>	<b>F</b>	<b>G</b>	<b>L</b>	<b>X</b>	<b>Y</b>	<b>H</b>	<b>W</b>			
	mm-inch	watt-Hp	mm	mm	mm	mm	mm	mm	mm	mm	mm	mm	mm	mm	mm	mm	mm	kg	mm	kg
<b>Mirra 220 C</b>	220/9"	147/0,20	13	245	230x240	395	245	500	560	370	570	475	505	220	125	160	160	15	600x500x420	17
<b>Mirra 250 C</b>	250/10"	147/0,20	13	245	230x240	395	245	500	560	370	570	475	490	220	145	180	170	16	600x500x420	18
<b>Mirra 275 C</b>	275/11"	147/0,20	13	245	230x240	395	245	535	560	370	570	475	475	215	160	200	190	17	600x500x420	20
<b>Mirra 300 Y09</b>	300/12"	210/0,29	13	285	250x275	435	295	600	610	420	640	510	535	250	185	225	210	20.5	800x600x520	23.5



MIRRA 220 C



MIRRA 250 C



MIRRA 275 C



# CANOVA



- Linea arrotondata priva di spigoli e viti a vista.
- Perno di scorrimento, cromato rettificato e lappato.
- Boccole di scorrimento autolubrificanti.
- Paracolpi su carrello in gomma vulcanizzata.
- Coperchio supporto vela smontabile.
- Parafetta in acciaio inox con incastro a baionetta.
- Tutte le minuterie acciaio inox.
- Sistema di tenuta stagna su puleggia.
- 41 mm di distanza fra lama e corpo macchina.
- Copertura inferiore.
- Scheda elettronica commutabile 110-220V monofase o 220-380V trifase.
- Affilatoio con vaschetta inferiore di protezione.
- Estrattore lama di serie versione 300.
- Inclinazione lama 38°.

- *Rounded design and no sharp edges and visible screws.*
- *Chrome plated ground and lapped slide rod.*
- *Self lubricating slide rod bushings.*
- *Vulcanized rubber stops on carriage.*
- *Removable support cover for thickness gauge plate.*
- *Stainless steel slice deflector with bayonet fitting*
- *Stainless steel screws and fittings.*
- *Enclosed and sealed belt pulley.*
- *41 mm distance between blade and motor.*
- *Bottom cover.*
- *Changeover electronic circuit 110-220V single or 220-280V three phase.*
- *Built in sharpening tool with bottom protection.*
- *Standard Blade Removal Tool (BRT) for 300 ver.*
- *38° blade inclination.*

## CANOVA

- Manopole plastica / Piedini in gomma / Interruttore isolato IP 44

## CANOVA TOP

- Manopola alluminio / Piedini in alluminio telescopici con base in gomma / Pulsanti IP 67 in acciaio inox.

## CANOVA

- Plastic knob. / Rubber feet. / Switch with IP44 protection rating.

## CANOVA TOP

- Aluminium knob. / Aluminium telescopic feet with rubber base / Stainless steel pushbuttons with IP67 protection rating.



CANOVA 300 TOP



Ampio spazio tra lama e corpo macchina  
*More space between blade and body machine*



Spazioso piano per appoggio prodotto  
*Large tray*

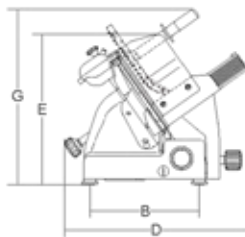
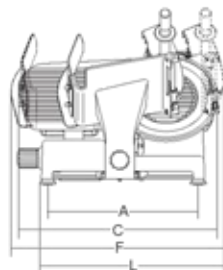

	A	B	C	D	E	F	G	L	X	Y	H	W	kg	mm	kg								
<b>Canova 250</b>	250/10"	147/0.20	19	275	240x230	428	290	580	495	365	680	500	550	230	140	190	175	24.5	800x600x520	27			
<b>Canova 275</b>	275/11"	210/0.29	19	275	240x230	428	290	580	495	360	650	495	530	230	155	208	185	25.5	800x600x520	28			
<b>Canova 300</b>	300/12"	210/0.29	19	275	250x275	428	290	590	495	355	640	495	515	260	175	223	207	26.5	800x600x520	29			

TOP



CANOVA 250



CANOVA 250 TOP



CANOVA 300



# CANOVA AUTOMEK



- Caratteristiche affettatrice come Canova 250-275-300.
- Struttura automatismo in acciaio inox saldato e arrotondato.
- Trascinamento carrello con sistema meccanico a biella.
- Motore trascinamento ventilato a comando separato con riduttore a bagno d'olio.
- Comandi separati per lama e automatismo.
- Possibilità di sblocco automatismo per un funzionamento manuale.
- 2 sistemi di controllo:
  - Standard on/off,
  - VV: on/off con variatore di velocità.
- *The Canova Automec series offers the same outstanding features of the Canova series adding:*
- *Welded and rounded stainless steel automatism structure.*
- *Piston/rod system carriage motion*
- *Fan-cooled carriage motion motor with commercial-grade oil bath reduction*
- *Blade and carriage motion powered by separate controls*
- *An easily accessible switch arm can convert the unit from automatic to manual operation*
- *Two control systems:*
  - *Standard on/off*
  - *Variable speed available (VV versions).*

CANOVA 300 AUTOMEK VV

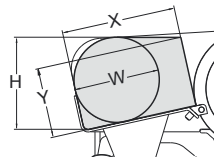
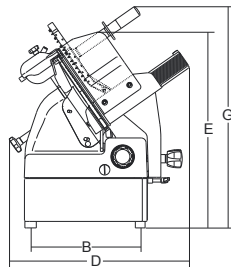
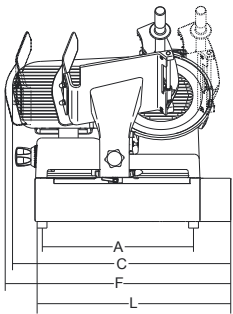

	mm-inch	watt-Hp	mm	mm	mm	mm	mm	mm	mm	mm	mm	mm	mm	mm	mm	mm	mm	kg	mm	kg
<b>Canova 300 Automec</b>	300/12"	210+180 0,29+0,24	19	275	250x275	428	290	590	495	573	640	650	515	260	175	223	207	42.6	870x840x750	57
<b>W</b>																				



Leva sollevamento, opzionale  
Lifting lever, optional





# PALLADIO



- Linea arrotondata priva di spigoli e viti a vista.
- Perno di scorrimento, cromato rettificato e lappato.
- Boccole di scorrimento autolubrificanti.
- Paracolpi su carrello in gomma vulcanizzata.
- Copercchio supporto vela smontabile.
- Parafetta in acciaio inox con incastro a baionetta.
- Tutte le minuterie acciaio inox.
- Sistema di tenuta stagna su puleggia.
- 49,5 mm di distanza fra lama e corpo macchina.
- Copertura inferiore.
- Scheda elettronica commutabile 110-220V.
- Affilatoio con vaschetta inferiore di protezione.
- Estrattore lama di serie.
- Inclinazione lama 35°.

- *Rounded design and no sharp edges and visible screws.*
- *Chrome plated ground and lapped slide rod.*
- *Self lubricating slide rod bushings.*
- *Vulcanized rubber stops on carriage.*
- *Removable support cover for thickness gauge plate.*
- *Stainless steel slice deflector with bayonet fitting*
- *Stainless steel screws and fittings.*
- *Enclosed and sealed belt pulley.*
- *49,5 mm distance between blade and motor.*
- *Bottom cover.*
- *Changeover electronic circuit 110-220V.*
- *Built in sharpening tool with bottom protection.*
- *Standard Blade Removal Tool (BRT).*
- *35° blade inclination.*

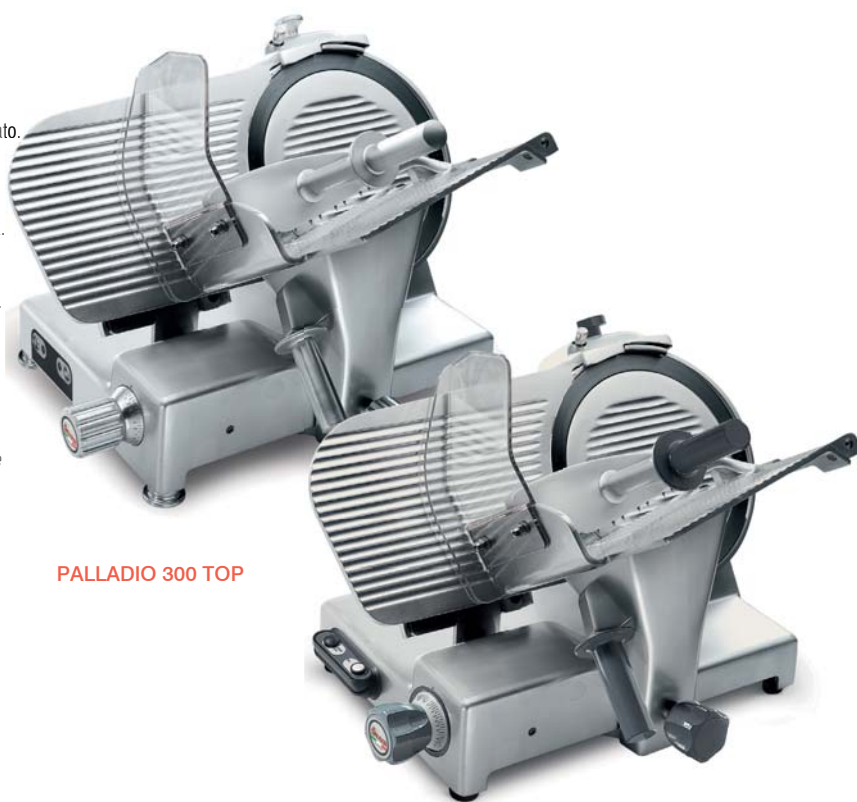

PALLADIO 300 TOP

PALLADIO 300

## PALLADIO

- Manopole plastica. Piedini in gomma.
- Pulsanti IP 67 in plastica.

## PALLADIO TOP

- Manopole alluminio.
- Piedini in alluminio telescopici con base in gomma.
- Pulsanti IP 67 in acciaio inox.
- Fornitura valigetta utensili.

## PALLADIO INGRANAGGI

- Trasmissione con riduttore ermetico a vite senza fine.
- Lubrificazione a bagno d'olio.
- Non disponibile versione automatica.

## PALLADIO AUT

- Pulsantiera ergonomica con pulsanti IP 67.
- 3 regolazioni della velocità.
- 3 regolazioni della corsa del carrello
- Conteggio delle fette effettuate.
- Impostazione delle fette da tagliare con stop automatico della macchina.
- Motore di trasmissione completamente stagno.
- Trasmissione del moto con cinghia dentata.
- Sistema di sgancio carrello per taglio manuale.
- Produzione fette al minuto: 37 - 70.

Accessori opzionali:  
Spondina per piatto.

## PALLADIO

- *Plastic knob. Rubber feet.*
- *Plastic pushbuttons with IP67 protection rating.*

## PALLADIO TOP

- *Knobs aluminum.*
- *Aluminium telescopic feet with rubber base.*
- *Stainless steel pushbuttons with IP67 protection rating.*
- *Maintenance tool kit.*

## PALLADIO INGRANAGGI

- *Enclosed and sealed worm gear reduction unit.*
- *Oil bath lubrication.*
- *Automatic model unavailable*

## PALLADIO AUT

- *Ergomic controls - push buttons with IP67 protection rating.*
- *3 speed selection.*
- *3 different adjustments for carriage travel.*
- *Slice counter.*
- *Slice number setting with automatic stop feature.*
- *Enclosed and sealed drive motor.*
- *Positive drive belt.*
- *Carriage release system for manual slicing.*
- *Output slices per minute: 37 - 70.*

Optional accessories:  
Food fence.



PALLADIO 330 TOP AUT.

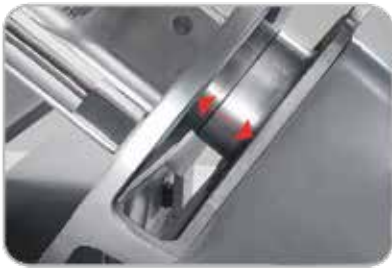

Ampio spazio tra lama e corpo macchina  
More space between blade and body machine



Spazioso piano per appoggio prodotto  
Large tray



Comandi Palladio AUT  
Palladio AUT controls



Leva sollevamento, opzionale  
Lifting lever, optional



Estrattore lama  
Blade Removal Tool (BRT)



Valigetta con kit di manutenzione di serie su versioni Top  
Small suitcase with maintenance kit standard on Top versions



Palladio AUT. Piatto Uniko opzionale  
Palladio AUT. with optional Uniko hopper

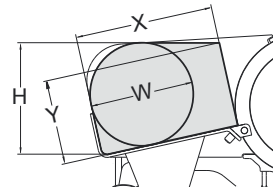
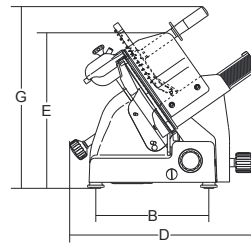
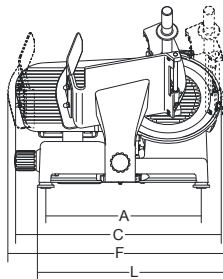

	mm-inch	watt-Hp	mm	mm	mm	A	B	C	D	E	F	G	L	X	Y	H	W	kg	mm	kg
Palladio 300	300/12"	275/0,37	23	310	305x270	465	340	615	547	465	710	545	600	270	190	240	220	35	760x640x700	44
Palladio 300 Ingr.	300/12"	400/0,54	23	310	305x270	465	340	615	547	465	710	545	600	270	190	240	220	36	760x640x700	45
Palladio 300 Aut.	300/12"	275+200/ 0,37+0,27	23	310	365x270	465	340	615	660	465	730	650	600	240/270	190	240	220	38	870x840x750	53
Palladio 330	330/13"	275/0,37	23	310	305x270	465	340	645	570	455	710	535	586	270	210	260	240	36	760x640x700	45
Palladio 330 Ingr.	330/13"	400/0,54	23	310	305x270	465	340	645	570	455	710	535	586	270	210	260	240	37	760x640x700	46
Palladio 330 Aut.	330/13"	275+200/ 0,37+0,27	23	310	365x270	465	340	645	660	455	730	650	586	240/270	210	260	240	39	870x840x750	54
Palladio 350	350/14"	370/0,50	23	310	305x270	465	340	660	575	455	710	530	580	270	225	275	250	37	760x640x700	46
Palladio 350 Ingr.	350/14"	400/0,54	23	310	305x270	465	340	660	575	455	710	530	580	270	225	275	250	38	760x640x700	47
Palladio 350 Aut.	350/14"	370+200/ 0,50+0,27	23	310	365x270	465	340	660	660	455	730	650	580	240/270	225	275	250	40	870x840x750	55

TOP



# PALLADIO AUTOMECC

- Caratteristiche affettatrice come Palladio 300-330-350.
- Struttura automatismo in acciaio inox saldato e arrotondato.
- Trascinamento carrello con sistema meccanico a biella.
- Motore trascinamento ventilato a comando separato con riduttore a bagno d'olio.
- Comandi separati per lama e automatismo.
- Possibilità di sblocco automatismo per un funzionamento manuale.
- Piatto Nettuno con sistema di guida prodotto regolabile.
- 2 sistemi di controllo:
  - Standard on/off,
  - VV: on/off con variatore di velocità.
- Produzione fette al minuto:
  - Palladio Automec: 37
  - Palladio Automec VV: 40 - 50



- *The Palladio Automec series offers the same outstanding features of the Palladio series adding:*
- *Welded and rounded stainless steel automatism structure.*
- *Piston/rod system carriage motion*
- *Fan-cooled carriage motion motor with commercial-grade oil bath reduction*
- *Blade and carriage motion powered by separate controls*
- *An easily accessible switch arm can convert the unit from automatic to manual operation*
- *The exclusive designed carriage "Nettuno" is available with a special end weight and an adjustable vertical product fence to provide stability and advance products evenly.*
- *Two control systems:*
  - Standard on/off
  - Variable speed available (VV versions).
- *Output slicer per minute:*
  - Palladio Automec: 37
  - Palladio Automec VV: 40 - 50



Contafette opzionale  
Optional slice counter

## PALLADIO 350 AUTOMECC FROZEN

- Appositamente studiata per il taglio di carni congelate fino a -12°C.

## PALLADIO 350 AUTOMECC FROZEN

- *Especially designed for slicing frozen meat up to -12°C.*

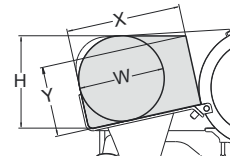
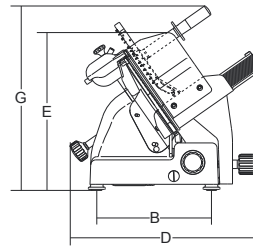
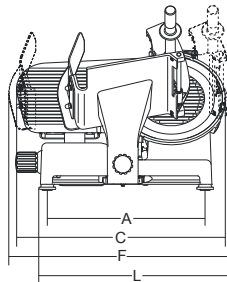

	mm-inch	watt-Hp	mm	mm	mm	A	B	C	D	E	F	G	L	X	Y	H	W	kg	mm	kg
Palladio 300 Automec	300/12"	275/180/ 0.37/0.24	23	310	365x270	465	340	667	660	670	685	750	615	240/270	190	240	220	55	840x840x750	70
Palladio 330 Automec	330/13"	275+180/ 0.37+0.24	23	310	365x270	465	340	684	660	670	700	750	-	240/270	210	260	240	56	870x840x750	71
Palladio 350 Automec	350/14"	370+180/ 0.50+0.24	23	310	365x270	465	340	685	660	670	700	750	-	240/270	225	275	250	57	870x840x750	72
- Palladio 350 Automec Frozen	350/14"	370+180/ 0.50+0.24	23	310	365x270	465	340	685	660	670	700	750	-	240/270	225	275	250	57	870x840x750	72



# PALLADIO EVO USA



- Particolare configurazione del basamento e della vela per impedire che sfridi e liquidi vadano nei dispositivi critici della macchina (pulsanti, manopola movimento, ecc.).
- Innovativo sistema di ribaltamento e smontaggio del piatto.
- Puleggia lama senza foro centrale per facilitare la pulizia.
- Movimento vela progressivo dei primi 3 mm di apertura, garantisce una maggiore precisione di regolazione taglio delle fette sottili.
- Anello di tenuta sull'albero vela per impedire che i liquidi percolino all'interno della macchina.
- Pulsanti in acciaio inox IP 67 in cassa.

- *Special configuration of the base and slicer table to prevent chips and liquids from entering the critical devices of the machine (buttons, turn knob, etc.).*
- *Hi-tech tipping system and feeding pan disassembly.*
- *Blade pulley without centre hole to facilitate cleaning.*
- *Adjustable slicer table movement in the first 3 mm of opening, guarantees higher cutting precision.*
- *Safety ring on table shaft to prevent liquids from seeping inside the machine.*
- *Buttons in insulated stainless steel (IP 67) in housing.*



1.



2.



3.



4.

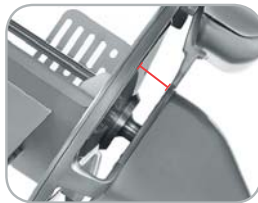

5.



6.

1. Leva sollevamento, opzionale  
*Lifting lever, optional*

2. Apertura carro per pulizia  
*Carriage tilting for easy cleaning*

3. Pratico smontaggio del coprilama  
*Easily removable blade cover*

4. Mozzo lama chiuso, senza tirante paralama  
*Closed blade hub, without tie rod for blade guard*

5. Ampio spazio tra lama e corpo macchina  
*More space between blade and body machine*

6. Movimento vela progressivo dei primi 3 mm di apertura, garantisce una maggiore precisione di regolazione taglio delle fette sottili.

*Adjustable slicer table movement in the first 3 mm of opening, guarantees higher cutting precision.*

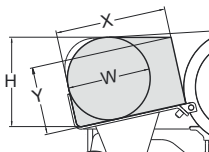
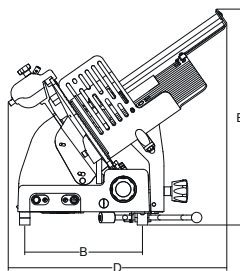
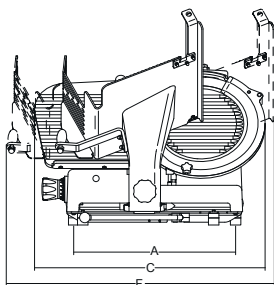

	mm-inch	watt-Hp	mm	mm	mm	mm	mm	mm	mm	mm	mm	mm	mm	mm	kg	mm	kg	
<b>Palladio 330 Evo Usa</b>	330/13"	275/0,37	23	310	350x290	465	340	660	630	620	730	270	165	260	225	40	870x840x750	55



# RAFFAELLO EVO

- Linea arrotondata priva di spigoli e viti a vista.
- Perno di scorrimento, cromato rettificato e lappato.
- Boccole di scorrimento autolubrificanti.
- Paracolpi su carrello in gomma vulcanizzata.
- Coperchio supporto vela smontabile.
- Parafetta in acciaio inox.
- Puleggia lama senza foro centrale per facilitare la pulizia.
- Movimento vela progressivo dei primi 3 mm di apertura, garantisce una maggiore precisione di regolazione taglio delle fette sottili.
- Anello di tenuta sull'albero vela per impedire che i liquidi percolino all'interno della macchina.
- Pratico smontaggio del coprilama
- Tutte le minuterie acciaio inox.
- 49,5 mm di distanza fra lama e corpo macchina.
- Copertura inferiore.
- Scheda elettronica commutabile 110-220V monofase o 220-380V trifase.
- Affilatoio con vaschetta inferiore di protezione.
- Estrattore lama di serie.
- Inclinazione lama 35°.

- *Rounded design and no sharp edges and visible screws.*
- *Chrome plated ground and lapped slide rod.*
- *Self lubricating slide rod bushings.*
- *Vulcanized rubber stops on carriage.*
- *Removable support cover for thickness gauge plate.*
- *Stainless steel slice deflector.*
- *Blade pulley without centre hole to facilitate cleaning.*
- *Adjustable slicer table movement in the first 3 mm of opening, guarantees higher cutting precision.*
- *Safety ring on table shaft to prevent liquids from seeping inside the machine.*
- *Easily removable blade cover*
- *Stainless steel screws and fittings.*
- *49,5 mm distance between blade and motor.*
- *Bottom cover.*
- *Changeover electronic circuit 110-220V single or 220-280V three phase.*
- *Built in sharpening tool with bottom protection.*
- *Standard Blade Removal Tool (BRT).*
- *35° blade inclination.*

## RAFFAELLO EVO

- Manopole plastica.
- Piedini in gomma.
- Pulsanti IP 67 in plastica

## RAFFAELLO EVO TOP

- Manopola alluminio.
- Piedini in alluminio telescopici con base in gomma.
- Pulsanti IP 67 in acciaio inox.
- Fornitura valigetta utensili.



RAFFAELLO 330 EVO TOP



RAFFAELLO 350 EVO

## RAFFAELLO EVO

- *Plastic knob.*
- *Rubber feet.*
- *Plastic pushbuttons with IP67 protection rating.*

## RAFFAELLO EVO TOP

- *Aluminum knob.*
- *Aluminium telescopic feet with rubber base.*
- *Stainless steel pushbuttons with IP67 protection rating.*
- *Maintenance tool kit.*



Pratico smontaggio del coprilama  
Easily removable blade cover



Mozzo lama chiuso, senza tirante paralama  
Closed blade hub, without tie rod for blade guard



Movimento vela progressivo dei primi 3 mm di apertura, garantisce una maggiore precisione di regolazione taglio delle fette sottili.  
Adjustable slicer table movement in the first 3 mm of opening, guarantees higher cutting precision.



Estrattore lama  
Blade Removal Tool (BRT)



Valigetta con kit di manutenzione di serie su versioni Top  
Small suitcase with maintenance kit standard on Top versions

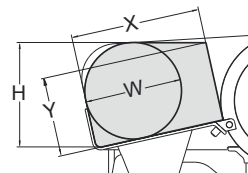
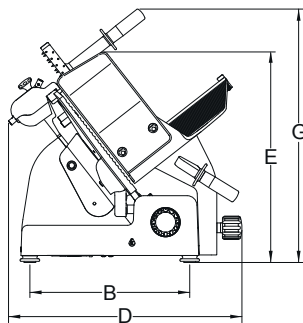
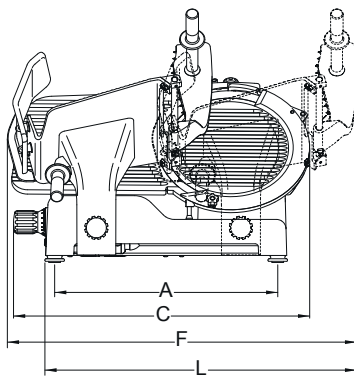

	mm-inch	watt-Hp	mm	mm	mm	mm	mm	mm	mm	mm	mm	mm	mm	mm	mm	mm	mm	kg	mm	kg
<b>Raffaello 330 Evo</b>	330/13"	275/0,37	23	355	330x307	513	340	690	560	475	840	595	680	307	205	260	240	37	760x640x700	46
<b>Raffaello 350 Evo</b>	350/14"	370/0,50	23	355	330x307	513	340	715	570	480	840	595	665	307	220	275	250	38	760x640x700	47
<b>Raffaello 370 Evo</b>	370/15"	370/0,50	23	355	330x307	513	340	735	580	470	840	590	660	307	230	285	260	39	760x640x700	48

TOP



# PALLADIO / GALILEO STONEHENGE

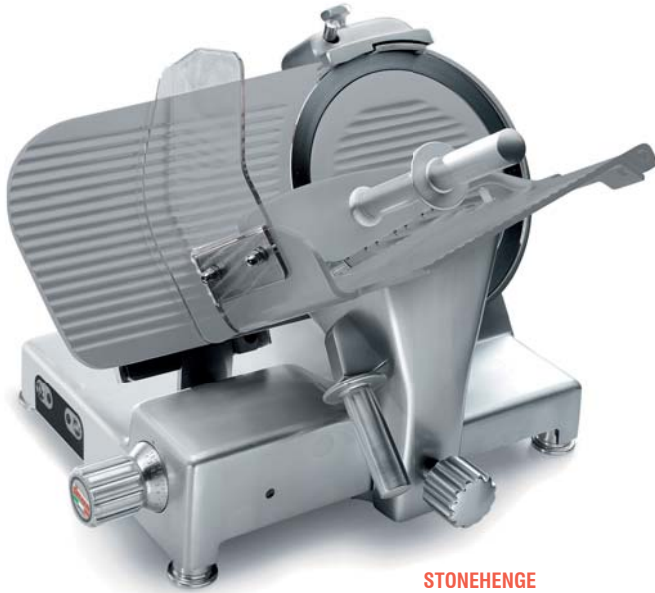

STONEHENGE

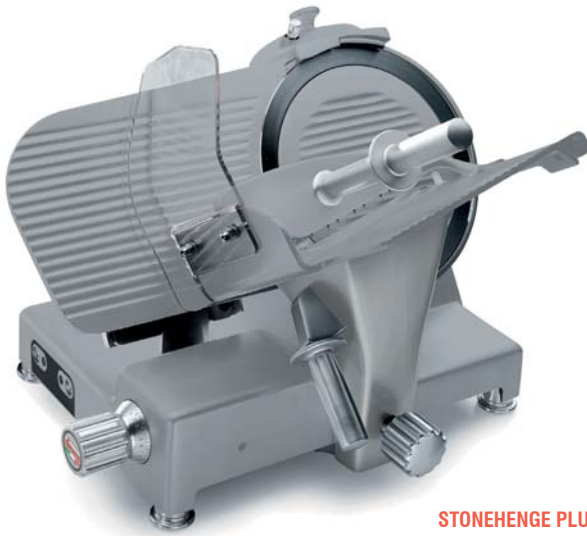

STONEHENGE PLUS

- Trattamento di ceramicatura superficiale.
- Ideale per la lavorazione di prodotti particolarmente collosi.
- Ottima scorrevolezza superficiale e semplice pulizia.
- Alta resistenza ad acidi e sanificanti.
- Parti rimovibili lavabili in lavastoviglie.
- Colore di finitura: grigio alluminio.

Versioni disponibili:

- **Stonehenge:** vela, paralama, piatto, pressamerce.
- **Stonehenge Plus:** cassa, vela, supporto vela e coperchio, anello, paralama, piatto, pressamerce, gambo, vaschetta e cappottina affilatoio.

- *Cast aluminum alloy with special ceramic coating treatment .*
- *Ideal for sticky products processing*
- *Excellent product gliding and easy to clean*
- *Highly resistant to acids and sanitizing chemicals*
- *Removable parts are dishwasher safe*
- *Aluminum-gray finish colour*

Available versions:

- **Stonehenge:** gauge plate, blade cover, hopper, product pusher.
- **Stonehenge Plus:** body, gauge plate, with support, blade ring, blade cover, hopper product pusher, sharpener cover.



Le Parti Rimovibili sono lavabili in lavastoviglie!  
*The Removable parts are dishwasher safe!*



# GALILEO EVO

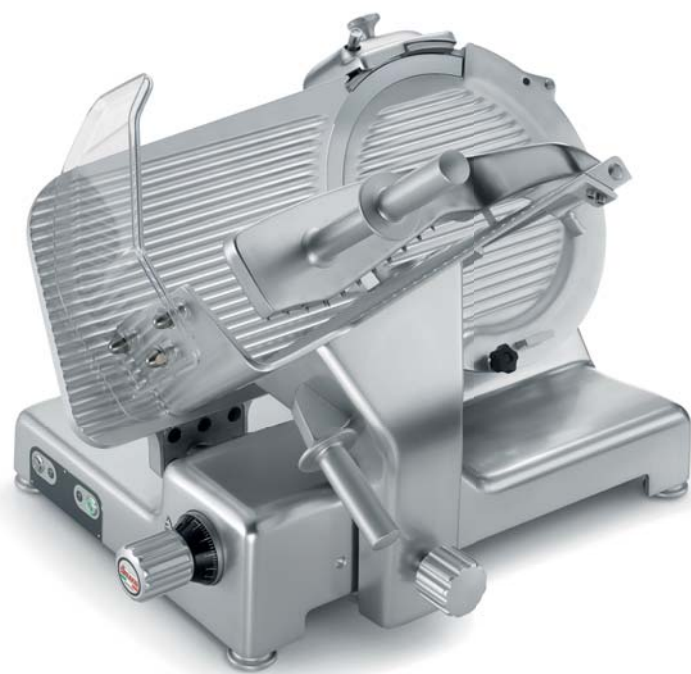

**GALILEO 350 EVO TOP**

- Linea arrotondata priva di spigoli e viti in vista.
- Perno di scorrimento, cromato rettificato.
- Boccole di scorrimento autolubrificanti.
- Paracolpi su carrello in gomma vulcanizzata.
- Coperchio supporto vela smontabile.
- Parafetta in acciaio inox.
- Puleggia lama senza foro centrale per facilitare la pulizia.
- Movimento vela progressivo dei primi 3 mm di apertura, garantisce una maggiore precisione di regolazione taglio delle fette sottili.
- Anello di tenuta sull'albero vela per impedire che i liquidi percolino all'interno della macchina.
- Pratico smontaggio del coprilama
- Tutte le minuterie acciaio inox.
- Copertura inferiore.
- Scheda elettronica commutabile 110-220V monofase o 220-380V trifase.
- Affilatoio con vaschetta inferiore di protezione.
- Estrattore lama di serie.
- Inclinazione lama 38°.

- *Rounded design, no sharp edges and visible screws.*
- *Chrome plated and ground slide rod.*
- *Self lubricating slide rod bushings.*
- *Vulcanized rubber stops on carriage.*
- *Removable support cover for thickness gauge plate.*
- *Stainless steel slice deflector.*
- *Blade pulley without centre hole to facilitate cleaning.*
- *Adjustable slicer table movement in the first 3 mm of opening, guarantees higher cutting precision.*
- *Safety ring on table shaft to prevent liquids from seeping inside the machine.*
- *Easily removable blade cover*
- *Stainless steel screws and fittings.*
- *Bottom cover.*
- *Changeover electronic circuit 110-220V single or 220-280V three phase.*
- *Built in sharpening tool with bottom protection.*
- *Standard Blade Removal Tool (BRT).*
- *38° blade inclination.*



**GALILEO 350 EVO TOP**

## **GALILEO EVO**

- Manopole plastica.
- Piedini in gomma.
- Pulsanti IP 67 in plastica.

## **GALILEO EVO TOP**

- Manopola alluminio.
- Lama G&B.
- Piedini in alluminio telescopici con base in gomma.
- Pulsanti IP 67 in acciaio inox.
- Fornitura valigetta utensili.

## **GALILEO EVO INGRANAGGI**

- Trasmissione con riduttore ermetico a vite senza fine.
- Lubrificazione a bagno d'olio.
- Non disponibile versione automatica.

## **GALILEO EVO AUTOMATICA**

- Pulsantiera ergonomica con pulsanti IP67.
- 3 regolazioni della velocità.
- 3 regolazioni della corsa del carrello.
- Conteggio delle fette effettuato.
- Impostazione delle fette da tagliare con stop automatico della macchina.
- Motore di trasmissione completamente stagno.
- Trasmissione del moto con cinghia dentata.
- Produzione fette al minuto: 24 - 46

## **ACCESSORI OPZIONALI:**

- Spondina per piatto.
- Tubo verdure.

## **GALILEO EVO**

- Plastic knob.
- Rubber feet.
- Plastic pushbuttons with IP67 protection rating.

## **GALILEO EVO TOP**

- Aluminium knob.
- G&B blade.
- Aluminium telescopic feet with rubber base.
- Stainless steel pushbuttons with IP67 protection rating.
- Maintenance tool kit.

## **GALILEO EVO INGRANAGGI**

- Transmission with sealed gear worm.
- Oil bath lubrication.
- Automatic model unavailable

## **GALILEO EVO AUTOMATICA**

- Ergonomic controls - pushbuttons with IP67 protection rating
- 3 speed selection.
- 3 different adjustments run for carriage.
- Slice counter
- Slice number setting with automatic stop feature.
- Enclosed and sealed drive motor.
- Positive drive belt.
- Output slices per minute: 24 - 46

## **OPTIONAL ACCESSORIES:**

- Food fence.
- Vegetables cote



70 mm di spazio tra lama e corpo macchina  
70 mm between the blade and the machine body space



Pratico smontaggio del copilama  
Easily removable blade cover



Mozzo lama chiuso, senza tirante paralama  
Closed blade hub, without tie rod for blade guard



Leva sollevamento, opzionale  
Lifting lever, optional



Galileo Ingranaggi  
Riduttore a bagno d'olio  
Oil bath gear box



Tubo verdure opzionale  
Optional vegetables cuto



Spondina per piatto opzionale  
Optional food fence



Design zavorra per piccoli salumi  
Fixing arm designed also for small sausages



Applicazione bilancia opzionale:  
Pesata max Kg 10 - precisione gr. 2  
piatto smontabile, formato mm 225x360

Optional scale application:  
Weighing 10 kg max - precision gr. 2  
Removable plate, format 225x360 mm



**GALILEO 370 EVO INGR. TOP**



**GALILEO 370 EVO**



**GALILEO 350 EVO USA TOP**



Gambe opzionali  
Optional legs



Comandi Galileo Evo AUT  
Galileo Evo AUT controls

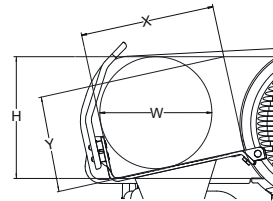
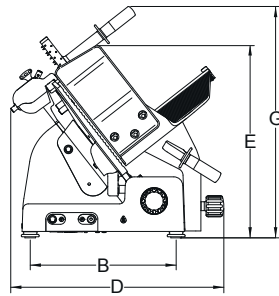
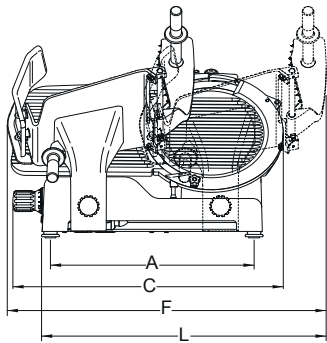

	mm-inch	watt-Hp	mm	mm	mm	A	B	C	D	E	F	G	L	X	Y	H	W	kg	mm	kg	
Galileo 350 Evo	350/14"	380/0,52	25	365	350x320	515	410	750	590	535	820	700	680	320	210	275	250	56	870x840x750	72	
Galileo 350 Evo Ingr.	350/14"	400/0,54	25	365	350x320	515	410	750	590	535	820	700	680	320	210	275	250	56	870x840x750	72	
Galileo 350 Evo Aut.	350/14"	380+400 0,52/0,54	25	365	430x320	515	410	750	640	535	820	730	680	285/320	210	275	250	62	870x840x750	78	
Galileo 350 Evo USA	350/14"	380/0,52	25	365	350x312	515	410	730	740	520	810	560	660	280	190	295	250	55	870x840x750	71	
Galileo 370 Evo	370/15"	380/0,52	25	365	350x320	515	410	760	600	530	820	700	675	320	230	290	270	57	870x840x750	73	
Galileo 370 Evo Ingr.	370/15"	400/0,54	25	365	350x320	515	410	760	600	530	820	700	675	320	230	290	270	57	870x840x750	73	
Galileo 370 Evo Aut	370/15"	380+400 0,52/0,54	25	365	430x320	515	410	760	650	530	820	730	675	285/320	225	295	266	63	870x840x750	79	
Galileo 385 Evo	385/16"	380/0,52	25	365	350x320	515	410	770	605	525	820	700	668	320	240	305	280	58	870x740x750	74	
Galileo 385 Evo Ingr.	385/16"	400/0,54	25	365	350x320	515	410	770	605	525	820	700	668	320	240	305	280	58	870x840x750	74	
Galileo 385 Evo Aut.	385/16"	380+400 0,52/0,54	25	365	430x320	515	410	770	655	525	820	730	668	285/320	230	305	280	64	870x840x750	80	

TOP



GALILEO 350 EVO AUT TOP



# GALILEO EVO POWER

- Pulsantiera ergonomica con pulsanti IP 67.
- 3 regolazioni della velocità.
- 3 regolazioni della corsa del carrello.
- Movimentazione carro a mezzo di cinghia dentata.
- Affettatrice montata su basamento carrellato in acciaio inox.
- Appositamente pensata per il taglio di carni congelate fino a -10°C.
- Produzione fette al minuto: 24 - 46.

- Ergomic controls - push buttons with IP67 protection rating.
- 3 speed selection.
- 3 different adjustments run for carriage.
- Positive drive belt on carriage.
- Sturdy stainless steel trestle with casters to provide stability.
- Especially designed for slicing frozen meat up to -10°C (14 °F).
- Output slices per minute: 24 - 46.

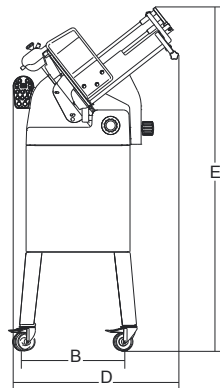
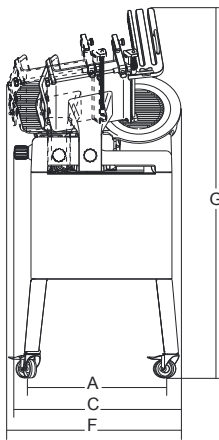
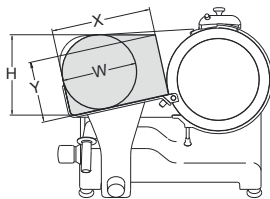

<b>Galileo 350 Evo Power</b>	350/14"	400/0,54 1100/1,5	25	365	430x320	610	455	730	732	1510	816	1620	325	210	275	250	98	870x840x1650	120



# MIRRA VERTICALE



MIRRA 300 VERT. BS

- Fusione in lega di alluminio anodizzato.
- Ampio spazio tra motore e lama per un'agevole pulizia.
- Motore ventilato.
- Lama forgiata e temprata a forte spessore.
- Perni scorrimento lappati.
- Viteria e parafetta in acciaio inox.
- Robusto supporto vela.
- Affilatoio incorporato in fusione con doppio smeriglio di serie.
- Dimensioni compatte ma con grande capacità di taglio.
- Versione CE Professionale con sblocco su carro.

- Anodized cast aluminum alloy.
- Great distance between blade and motor for easy cleaning.
- Ventilated motor.
- Forged, hardened large thickness blades.
- Ground slide rod plate finished.
- Stainless steel screws and slice deflector.
- Strong thickness gauge support.
- Cast-in sharpener assembly.
- Compact dimensions but great cutting capacity.
- Device for releasing the carriage on CE version.

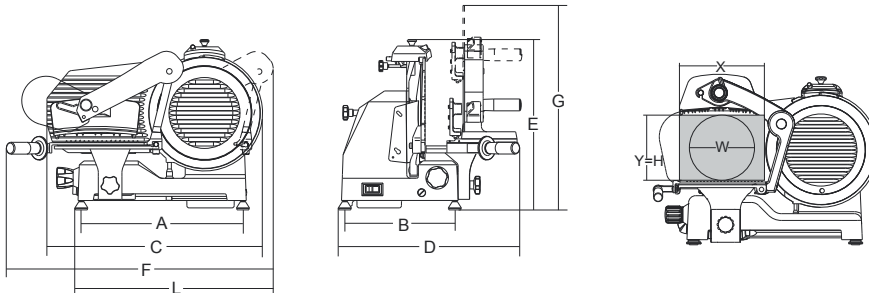

						A	B	C	D	E	F	G	L	X	Y	H	W			
	mm-inch	watt-Hp	mm	mm	mm	mm	mm	mm	mm	mm	mm	mm	mm	mm	mm	mm	mm	kg	mm	kg
Mirra 220 C Vert.	220/9"	147/0,20	13	225	230x235	400	260	500	535	400	570	405	475	205	150	150	150	16.5	600x500x500	19
Mirra 250 C Vert.	250/10"	147/0,20	13	230	230x235	400	260	510	535	410	570	410	475	205	170	170	170	17.5	600x500x500	20
Mirra 250 C Vert. BS	250/10"	147/0,20	13	215	275x260	400	260	510	480	415	700	600	540	270	190	190	190	21.5	600x500x500	24
Mirra 275 C Vert.	275/11"	147/0,20	13	220	230x235	400	260	530	535	420	570	425	465	225	205	205	205	18.5	600x500x500	21
Mirra 275 C Vert. BS	275/11"	147/0,20	13	225	275x260	400	260	530	480	420	700	770	540	270	200	200	200	22.5	600x500x500	25
Mirra 275 Vert. BS	275/11"	210/0,29	13	220	275x260	440	300	580	500	455	740	630	580	255	205	205	205	26	800x600x520	28.5
Mirra 300 Vert. BS	300/12"	210/0,29	13	265	275x260	440	300	585	540	460	740	770	580	255	215	215	215	27	800x600x520	29.5



MIRRA 250 C VERT.



Mirra 250-275 C VERT. BS



MIRRA 275 C VERT.



# GIOTTO



- Linea arrotondata priva di spigoli e facile da pulire.
- Perno di scorrimento, cromato rettificato e lappato.
- Boccole di scorrimento autolubrificanti.
- Paracolpo su carrello in gomma vulcanizzata.
- Coperchio supporto vela smontabile.
- Parafetta rimovibile in acciaio inox con incastro rapido a baionetta.
- Tutte le minuterie acciaio inox.
- Copertura inferiore con coperchio per accesso diretto ai componenti elettrici.
- Scheda elettronica commutabile 110-220V.
- Affilatoio con vaschetta inferiore di protezione.
- Sistema di tenuta stagna su puleggia.
- 41 mm di distanza fra lama e corpo macchina.

- *Innovative rounded design and no sharp edges or visible screws*
- *Chrome plated ground and lapped slide rod.*
- *Self lubricating slide rod bushings.*
- *Vulcanised rubber stops on carriage.*
- *Removable support cover for thickness gauge plate.*
- *Stainless steel slice deflector with snap-on bayonet fitting.*
- *Stainless steel screws and fittings.*
- *Bottom cover with lid for accessing electrical components.*
- *Changeover electronic circuit 110-220V.*
- *Built in sharpening tool with bottom protection.*
- *Enclosed and sealed belt pulley.*
- *41 mm distance between blade and motor.*



**GIOTTO 300 BS1 TOP**

#### GIOTTO

- Manopole in plastica.
- Piedini in gomma.
- Interruttore isolato IP 44

#### GIOTTO TOP

- Manopole in alluminio.
- Piedini in alluminio telescopici con base in gomma.
- Pulsanti IP 67 in acciaio inox

#### GIOTTO BS1

- Braccio stringi salumi con staffa in acciaio inox.

#### GIOTTO VCO

- Particolarmente richieste nei mercati nordici.
- Piatto a vasca per tagliare ogni tipo di prodotto.
- Staffa blocca prodotto in alluminio smontabile con chiodi in acciaio e denti fresati sul lato lama.

#### GIOTTO

- Plastic knobs.
- Rubber feet.
- Switch with IP44 protection rating.

#### GIOTTO TOP

- Aluminium knobs.
- Aluminium telescopic feet with rubber base.
- Stainless steel pushbuttons with IP67 protection rating

#### GIOTTO BS1

- Easy to remove stainless steel meat grip arm.

#### GIOTTO VCO

- Specially required by the Northern European marketplace
- Product table designed to slice all types of products.
- Removable aluminum end weight.



**GIOTTO 300 VCO TOP**



**GIOTTO 300 BS1**



Zavorra smontabile BS1  
Removable food pusher BS1



Ampio spazio tra lama e corpo macchina  
More space between blade and body machine



Spazioso piano per appoggio prodotto  
Large tray

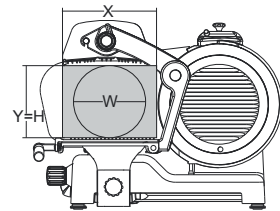
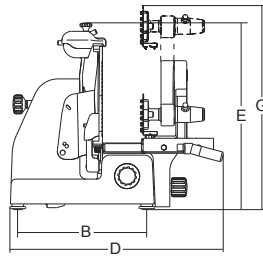
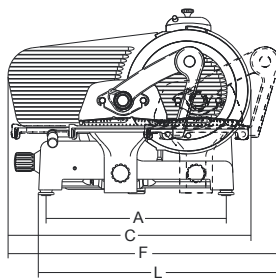

	mm-inch	watt-Hp	mm	mm	mm	mm	mm	mm	mm	mm	mm	mm	mm	mm	mm	mm	mm	kg	mm	kg
<b>Giotto 250 BS1</b>	250/10"	210/0,29	30	275	275x260	425	320	550	540	435	790	550	620	255	190	190	190	27	800x600x520	30
<b>Giotto 250 VCO</b>	250/10"	210/0,29	30	275	250x240	425	320	550	590	435	640	475	540	240	190	190	190	26	800x600x520	29
<b>Giotto 275 BS1</b>	275/11"	210/0,29	30	275	275x260	425	320	560	540	450	790	560	620	255	205	205	205	28	800x600x520	31
<b>Giotto 275 VCO</b>	275/11"	210/0,29	30	275	250x240	425	320	560	590	450	640	485	540	240	205	205	205	27	800x600x520	30
<b>Giotto 300 BS1</b>	300/12"	210/0,29	30	275	275x260	425	320	580	540	460	790	570	620	255	220	220	220	29	800x600x520	32
<b>Giotto 300 VCO</b>	300/12"	210/0,29	30	275	250x240	425	320	580	590	460	640	495	540	240	220	220	220	28	800x600x520	31

TOP





# MANTEGNA



YouTube

- Linea arrotondata priva di spigoli e facile da pulire.
- Perno di scorrimento, cromato rettificato e lappato.
- Boccole di scorrimento autolubrificante.
- Paracolpo su carrello in gomma vulcanizzata.
- Coperchio supporto vela smontabile.
- Parafetta rimovibile in acciaio inox con incastro rapido a baionetta.
- Tutte le minuterie acciaio inox.
- Copertura inferiore con accesso diretto ai componenti elettrici.
- Scheda elettronica commutabile 110-220V monofase o 220-380V trifase.
- Affilatoio con vaschetta inferiore di protezione.
- Sistema di tenuta stagna su puleggia.
- 48 mm di distanza fra lama e corpo macchina.
- Estrattore lama di serie.

- *Innovative rounded design and no sharp edges or visible screws*
- *Chrome plated ground and lapped slide rod.*
- *Self lubricating slide rod bushings.*
- *Vulcanised rubber stops on carriage.*
- *Removable support cover for thickness gauge plate.*
- *Stainless steel slice deflector with snap-on bayonet fitting.*
- *Stainless steel screws and fittings.*
- *Bottom cover for accessing electrical components.*
- *Changeover electronic circuit 110-220V single or 220-280V three phase.*
- *Built in sharpening tool with bottom protection.*
- *Enclosed and sealed belt pulley.*
- *48 mm distance between blade and motor.*
- *Standard Blade Removal Tool (BRT).*



**MANTEGNA 300 BS1 TOP**

## MANTEGNA

- Manopole in plastica.
- Piedini in gomma.
- Pulsanti IP 67 in plastica

## MANTEGNA TOP

- Manopole alluminio.
- Piedini in alluminio telescopici con base in gomma.
- Pulsanti IP 67 in acciaio inox.
- Kit manutenzione e sanificazione in pratica valigetta.

## MANTEGNA BS1

- Braccio stringisalumi con staffa chiodata inox rimovibile per la pulizia.

## MANTEGNA VCO

- Particolarmente richieste nei mercati nordici.
- Piatto a vasca per tagliare ogni tipo di prodotto.
- Staffa blocca prodotto in alluminio smontabile.
- Staffa con chiodi in acciaio e denti fresati sul lato lama.
- Disponibile anche nella versione con braccetto mobile.

## MANTEGNA

- Plastic knobs.
- Rubber feet.
- Plastic pushbuttons with IP67 protection rating.

## MANTEGNA TOP

- Knobs aluminum.
- Aluminium telescopic feet with rubber base.
- Stainless steel pushbuttons with IP67 protection rating.
- Maintenance tool kit.

## MANTEGNA BS1

- Easy to remove stainless steel meat grip arm.

## MANTEGNA VCO

- Specially required by the Northern European marketplace
- Product table designed to slice all types of products.
- Removable aluminum end weight.
- Designed with grooves: nails underneath.
- Available with double articulating arm on end weight



**MANTEGNA 300 BS1**



**MANTEGNA 300 VCS**

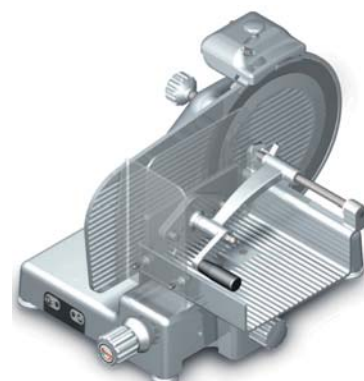

**MANTEGNA 300 VCO BM TOP**





Zavorra smontabile BS1  
Removable food pusher BS1

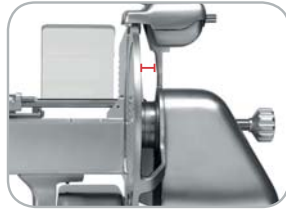

Ampio spazio tra lama e corpo macchina  
More space between blade and body machine



Zavorra smontabile VCS  
Removable food pusher VCS



Comandi per le versioni Top, di serie  
Standard controls for Top versions

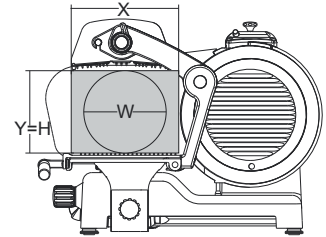
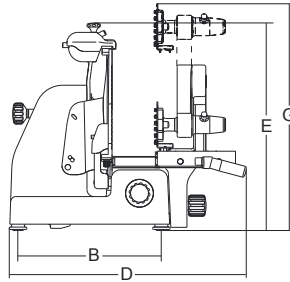
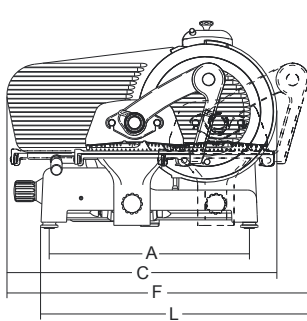

	mm-inch	watt-Hp	mm	mm	mm	mm	mm	mm	mm	mm	mm	mm	mm	mm	mm	mm	mm	kg	mm	kg
Mantegna 300 BS1	300/12"	275/0,37	29	310	300x270	468	338	635	600	500	750	695	650	270	230	230	230	36.5	870x840x750	51.5
Mantegna 300 VCS	300/12"	275/0,37	29	310	340x250	468	338	635	685	500	720	560	610	250	225	225	225	36	870x840x750	52
Mantegna 300 VCO	300/12"	275/0,37	29	310	280x260	468	338	635	652	500	677	520	610	260	230	230	230	35	870x840x750	50
Mantegna 300 VCO BM	300/12"	275/0,37	29	310	280x260	468	338	635	585	500	677	660	610	260	230	230	230	36	870x840x750	51
Mantegna 330 BS1	330/13"	275/0,37	29	310	300x270	468	338	645	600	515	750	705	630	270	245	245	245	37	870x840x750	52
Mantegna 330 VCS	330/13"	275/0,37	29	310	340x250	468	338	645	685	515	720	560	580	250	235	235	235	37	870x840x750	53
Mantegna 330 VCO	330/13"	275/0,37	29	310	280x260	468	338	645	652	515	677	520	585	260	245	245	245	36	870x840x750	51
Mantegna 330 VCO BM	330/13"	275/0,37	29	310	280x260	468	338	645	585	515	677	660	585	260	245	245	245	37	870x840x750	52
Mantegna 350 BS1	350/14"	370/0,50	29	310	300x270	468	338	660	600	530	750	715	630	270	255	255	255	38	870x840x750	53
Mantegna 350 VCS	350/14"	370/0,50	29	310	340x250	468	338	660	685	530	720	560	580	250	245	245	245	38	870x840x750	54
Mantegna 350 VCO	350/14"	370/0,50	29	310	280x260	468	338	660	652	530	677	520	585	260	255	255	255	38	870x840x750	53
Mantegna 350 VCO BM	350/14"	370/0,50	29	310	280x260	468	338	660	585	530	677	660	585	260	255	255	255	38	870x840x750	53

TOP



MANTEGNA 300 VCO TOP



MANTEGNA 300 VCS TOP



# TIZIANO EVO

- Linea arrotondata priva di spigoli e viti in vista.
- Perno di scorrimento, cromato e lappato.
- Boccole di scorrimento autolubrificanti.
- Paracolpi su carrello in gomma vulcanizzata.
- Coperchio supporto vela smontabile.
- Parafetta in acciaio inox.
- Puleggia lama senza foro centrale per facilitare la pulizia.
- Movimento vela progressivo dei primi 3 mm di apertura, garantisce una maggiore precisione di regolazione taglio delle fette sottili.
- Anello di tenuta sull'albero vela per impedire che i liquidi percolino all'interno della macchina.
- Pratico smontaggio del coprilama
- Tutte le minuterie acciaio inox.
- 48 mm di distanza fra lama e corpo macchina.
- Copertura inferiore.
- Scheda elettronica commutabile 110-220V monofase o 220-380V trifase.
- Affilatoio con vaschetta inferiore di protezione.
- Estrattore lama di serie.

- *Rounded design, no sharp edges and visible screws.*
- *Chrome plated ground and lapped slide rod.*
- *Self lubricating slide rod bushings.*
- *Vulcanized rubber stops on carriage.*
- *Removable support cover for thickness gauge plate.*
- *Stainless steel slice deflector.*
- *Blade pulley without centre hole to facilitate cleaning.*
- *Adjustable slicer table movement in the first 3 mm of opening, guarantees higher cutting precision.*
- *Safety ring on table shaft to prevent liquids from seeping inside the machine.*
- *Easily removable blade cover*
- *Stainless steel screws and fittings.*
- *48 mm distance between blade and motor.*
- *Bottom cover.*
- *Changeover electronic circuit 110-220V single or 220-280V three phase.*
- *Built in sharpening tool with bottom protection.*
- *Standard Blade Removal Tool (BRT).*



**TIZIANO 350 EVO BS1 TOP**

### TIZIANO EVO

- Manopole in plastica.
- Piedini in gomma.
- Pulsanti IP 67 in plastica

### TIZIANO EVO TOP

- Manopole alluminio
- Piedini in alluminio telescopici con base in gomma.
- Pulsanti IP 67 in acciaio inox
- Kit manutenzione e sanificazione in pratica valigetta.

### TIZIANO EVO BS1

- Braccio stringisalumi con staffa chiodata inox rimovibile per la pulizia.

### TIZIANO EVO

- Plastic knobs.
- Rubber feet.
- Plastic pushbuttons with IP67 protection rating.

### TIZIANO EVO TOP

- aluminum knobs
- Aluminium telescopic feet with rubber base.
- Stainless steel pushbuttons with IP67 protection rating
- Maintenance tool kit.

### TIZIANO EVO BS1

- Easy to remove stainless steel meat grip arm.



**TIZIANO 350 EVO BS1**



**TIZIANO 350 EVO VCS TOP**



**TIZIANO 350 EVO VCS**



Zavorra smontabile BS1  
Removable food pusher BS1

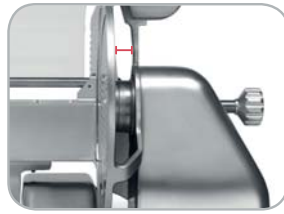

Ampio spazio tra lama e corpo macchina  
More space between blade and body machine



Zavorra smontabile VCS  
Removable food pusher VCS



Comandi per le versioni Top, di serie  
Standard controls for Top versions



Estrattore lama  
Blade Removal Tool (BRT)



Valigetta con kit di manutenzione di serie su versioni Top  
Small suitcase with maintenance kit standard on Top versions

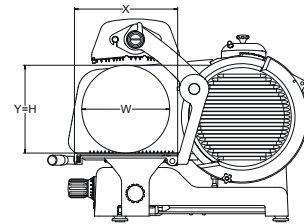
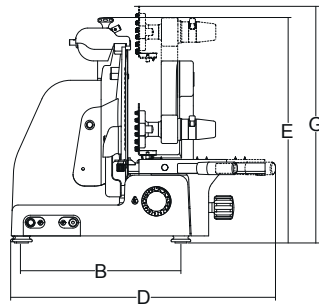
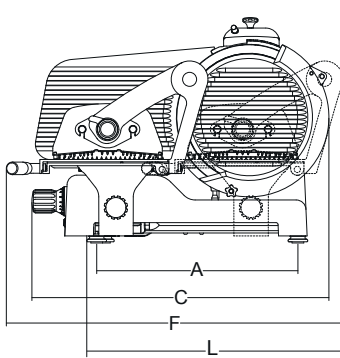

	min-inch	watt-Hp	mm	mm	mm	mm	mm	mm	mm	mm	mm	mm	mm	mm	mm	mm	kg	mm	kg	
<b>Tiziano 350 Evo BS1</b>	350/14"	380/0,52	29	355	305x295	513	338	719	601	541	766	673	684	305	255	255	255	41.5	870x840x830	57.5
<b>Tiziano 350 Evo VCS</b>	350/14"	380/0,52	29	355	350x287	513	338	719	681	538	808	550	670	287	245	245	245	42	870x840x830	58
<b>Tiziano 370 Evo BS1</b>	370/15"	380/0,52	29	355	305x295	513	338	730	601	551	766	664	683	305	270	270	270	42.5	870x840x830	58.5
<b>Tiziano 370 Evo VCS</b>	370/15"	380/0,52	29	355	350x287	513	338	729	681	551	808	550	670	287	260	260	260	43	870x840x830	59

TOP



# LEONARDO EVO



- Linea arrotondata priva di spigoli e viti a vista.
- Affettatrice collocabile su un piano di lavoro da 70 cm.
- Lama a costa bassa per minimizzare l'attrito con il prodotto
- Perno di scorrimento, cromato rettificato e lappato.
- Ottimo scorrimento del carro grazie alle boccole in ghisa lappate.
- Carrello ammortizzato con paracolpi in gomma vulcanizzata.
- Parafetta in acciaio inox
- Sistema di tenuta stagna su puleggia.
- Puleggia lama senza foro centrale per prevenire infiltrazioni e facilitare la pulizia.
- Movimento vela progressivo dei primi 3 mm di apertura, garantisce una maggiore precisione di regolazione taglio delle fette sottili.
- Pratico smontaggio del coprilama
- Tutte le minuterie in acciaio inox.
- Affilatoio con vaschetta inferiore di protezione.
- Paragrasso in acciaio inox facilmente smontabile.
- Altezza di lavoro agevolata per aiutare l'operatore
- 70 mm di distanza fra lama e corpo macchina.
- Estrattore lama di serie.

- *Rounded design and no sharp edges and visible screws.*
- *Size can fit 70 cm deep table*
- *Low profile reduced friction blade*
- *Chrome plated ground and lapped slide rod.*
- *Smooth sliding thanks to lapped iron bushings*
- *Vulcanised rubber stops on carriage.*
- *Stainless steel slice deflector*
- *Enclosed and sealed belt pulley.*
- *Blade pulley without centre hole to facilitate cleaning.*
- *Adjustable slicer table movement in the first 3 mm of opening, guarantees higher cutting precision.*
- *Easily removable blade cover*
- *All stainless steel hardware.*
- *Built in sharpening tool with bottom protection.*
- *Easy to remove grease guard.*
- *Working height facilitated to help the operator*
- *70 mm distance between blade and motor.*
- *Standard Blade Removal Tool (BRT).*



LEONARDO 350 EVO BS2 TOP

### LEONARDO EVO

- Manopole plastica.
- Piedini in gomma.
- Pulsanti IP 67 in plastica.

### LEONARDO EVO

- Plastic knob.
- Rubber feet.
- Plastic pushbuttons with IP67 protection rating.

### LEONARDO EVO TOP

- Manopole alluminio.
- Lama G&B costa bassa.
- Piedini in alluminio telescopici con base in gomma.
- Pulsanti IP 67 in acciaio inox.
- Valigetta con utensili manutenzione e CD dimostrativo.

### LEONARDO EVO TOP

- Knobs aluminum.
- G&B blade.
- Aluminium telescopic feet with rubber base.
- Stainless steel pushbuttons with IP67 protection rating.
- Maintenance tool kit and demo CD.



LEONARDO 350 EVO BS1

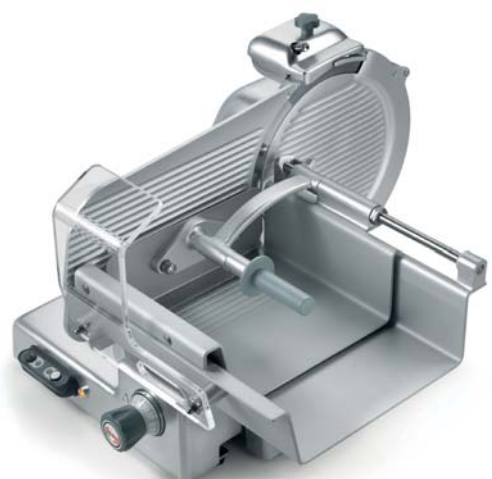

LEONARDO 350 EVO VCS

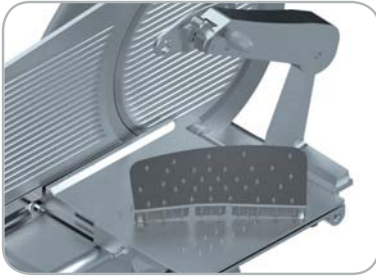

Zavorra smontabile BS1  
Removable food pusher BS1



Zavorra smontabile BS2  
Removable food pusher BS2



Zavorra smontabile BS3 a tenuta d'acqua.  
Removable food pusher BS3 waterproof.



#### LEONARDO EVO BS1

- Braccio blocca salume con staffa in acciaio inox facilmente smontabile.

#### LEONARDO EVO BS2

- Braccio con apertura agevolata e manopola ergonomica.
- Sistema integrato che all'apertura allontana automaticamente la staffa dalla lama.
- Staffa di grandi dimensioni in acciaio inox facilmente smontabile.
- Piano e scorrevoli perfettamente paralleli, con rialzo per sostegno prodotto.

#### LEONARDO EVO BS3

- Braccio stagno anche per lavaggio con acqua (escluso lavastoviglie, idropulitrice, immersione).
- Manopola ergonomica ed apertura agevolata.
- Sistema integrato che all'apertura allontana automaticamente la staffa dalla lama.
- Staffa basculante per adattarsi a qualsiasi prodotto.
- Staffa smontabile di grandi dimensioni in acciaio inox.



Zavorra smontabile VCS  
Removable food pusher VCS

#### LEONARDO EVO BS1

- Easy to remove stainless steel meat grip arm.

#### LEONARDO EVO BS2

- Easy to raise arm with ergonomic handgrip.
- While opening it automatically backs off the blade.
- Amply dimensioned stainless arm easy to remove.
- Tray and slides perfectly parallel, and with raised plate for improved food grip.

#### LEONARDO EVO BS3

- Water-resistant, double-sealed clamping arm (except dishwasher, pressure washer, immersion).
- Easy to open and adjust thanks to the ergonomic handle.
- While opening it automatically backs off the blade.
- Tilting bracket to fit any product.
- Toggling and removable stainless steel end weight to hold products firmly in place.



LEONARDO 385 EVO VCS TOP



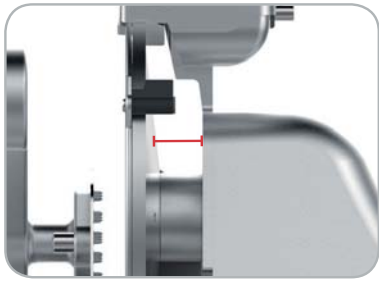

Ampio spazio tra lama e corpo macchina  
More space between blade and body machine



Massima vicinanza alla lama  
Maximum proximity to the blade



Comandi per le versioni Top, di serie  
Standard controls for Top versions



Di serie su versioni Top  
Piedini in alluminio telescopici con base in gomma  
Standard on versions Top  
Aluminium telescopic feet with rubber base



Movimento vela progressivo dei primi 3 mm di apertura, garantisce una maggiore precisione di regolazione taglio delle fette sottili.  
Adjustable slicer table movement in the first 3 mm of opening, guarantees higher cutting precision.



Parafetta in acciaio  
Stainless steel slice deflector



Paracolpo carrello  
Hopper's buffer



Affilatoio incorporato  
Incorporated sharpener



Protezione inferiore  
Bottom shield



**Applicazione bilancia opzionale:**

Pesata max Kg 10 - precisione gr. 2 piatto smontabile, formato mm 225x360

**Optional scale application:**

Weighing 10 kg max - precision gr. 2 removable plate, format 225x360 mm



Estrattore lama  
Blade Removal Tool (BRT)



Valigetta con kit di manutenzione di serie su versioni Top  
Small suitcase with maintenance kit standard on Top versions

Leonardo Evo BS 1 / 2 / 3

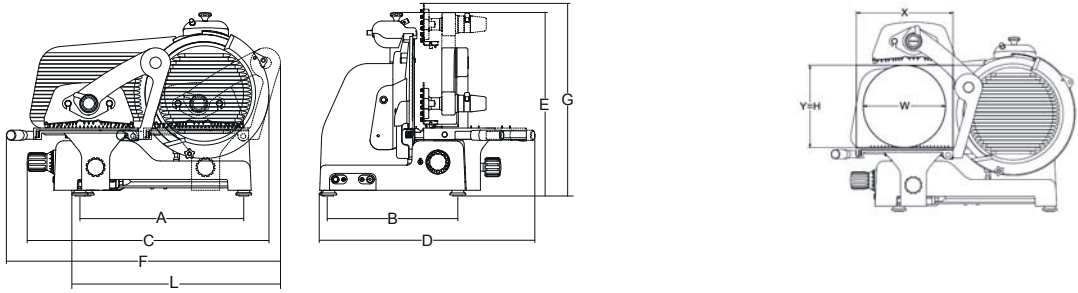

Leonardo Evo VCS

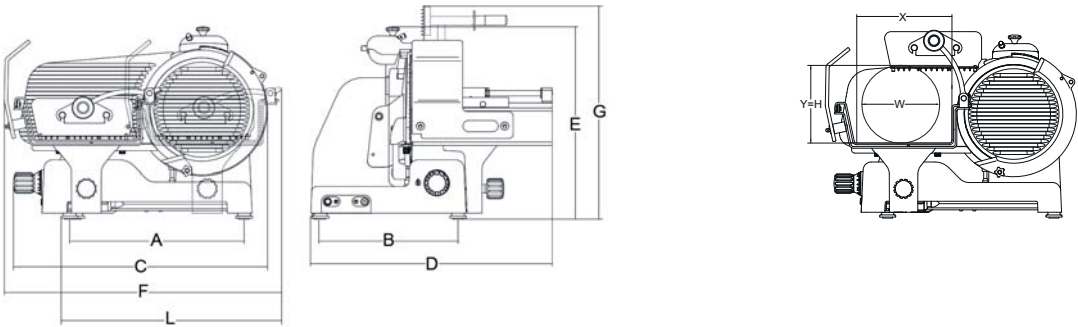

	mm-inch	watt-Hp	mm	mm	mm	mm	mm	mm	mm	mm	mm	mm	mm	mm	mm	mm	mm	kg	mm	kg
- Leonardo 350 Evo BS1	350/14"	380/0,52	25	370	350x330	515	410	733	676	570	876	633	670	330	250	250	250	56	870x840x830	72
Leonardo 350 Evo BS2 Top	350/14"	380/0,52	25	370	350x330	515	410	750	676	567	887	635	677	330	250	250	250	59	870x840x830	75
Leonardo 350 Evo VCS	350/14"	380/0,52	25	370	430x300	515	410	750	742	570	830	595	656	295	240	240	240	60	870x840x830	76
- Leonardo 370 Evo BS1	370/15"	380/0,52	25	370	350x330	515	410	750	676	580	876	624	670	330	270	270	270	58	870x840x830	74
Leonardo 370 Evo BS2 Top	370/15"	380/0,52	25	370	350x330	515	410	760	676	577	887	626	677	330	270	270	270	60	870x840x830	76
Leonardo 370 Evo VCS	370/15"	380/0,52	25	370	430x300	515	410	760	742	580	830	586	656	295	258	258	258	61	870x840x830	77
- Leonardo 385 Evo BS1	385/16"	380/0,52	25	370	350x330	515	410	766	676	600	876	624	690	330	280	280	280	59	870x840x830	75
Leonardo 385 Evo BS2 Top	385/16"	380/0,52	25	370	350x330	515	410	767	676	597	887	626	677	330	280	280	280	61	870x840x830	77
Leonardo 385 Evo VCS	385/16"	380/0,52	25	370	430x300	515	410	770	742	600	830	606	656	295	272	272	272	62	870x840x830	78

TOP



LEONARDO 350 EVO BS2 TOP

LEONARDO 350 EVO VCS TOP

## RISTORAZIONE

Ideata nei minimi dettagli per risolvere tutte le problematiche legate alla gestione della cucina professionale, la linea di macchine per la ristorazione progettate e prodotte da Sirman vanta una grande varietà di proposte che vanno dal tagliaverdure al pelapatate, dalle grattuge al cutter multiuso e a molti altri strumenti estremamente preziosi per garantire un risultato di qualità.

Contraddistinti da un disegno originale ed elegante, tali strumenti assicurano tutti la massima funzionalità ed igiene grazie alla scelta di selezionati materiali di costruzione e al pieno rispetto delle più severe norme di sicurezza alimentare.

## FOOD PROCESSORS

*Developed with care over even the tiniest detail to deal with all the problems encountered in running a professional kitchen, this range of catering appliances designed and manufactured by Sirman can boast a great variety of options that range from the vegetable-parer to the potato-peeler, from the grater to the all-purpose food-cutter and many other extremely precious tools for ensuring good-quality results.*

*Distinguished by an original and elegant design, these tools all guarantee the utmost in practicality and hygiene thanks to the choice of carefully-selected materials for their manufacture and compliance with the most severe standards concerning the safety of foodstuffs.*







# SINFONIA 2

## macchina per la pasta fresca *pasta machine*



- Adatta alle esigenze del piccolo e medio ristorante.
- Pratica, veloce ed estremamente facile da pulire e sanificare.
- Costruzione in acciaio inox AISI 304.
- Potente motore ventilato con riduzione ad ingranaggi a bagno d'olio.
- Performante pala impastatrice facilmente rimovibile.
- Coperchio in acciaio inox interbloccato.
- Pratica e rimovibile tramoggia per versare la parte liquida in modo ottimale.
- Coclea, bocca e ghiera in acciaio inox.
- Ampia disponibilità di trafilè in bronzo.
- Motorino tagliapasta con variatore opzionale.
- Vasca in alluminio anodizzato
- Comandi IP 54
- Sistema di ventilazione forzata anche a motore spento.

- *Designed for medium-duty operations, ideal for small to medium-size restaurants.*
- *Reliable, user-friendly and easy to clean.*
- *AISI 304 stainless steel body.*
- *Powerful, air-cooled motor with oil bath gear box reducer.*
- *High-performance and easy to remove kneading paddle.*
- *Interlocked stainless steel lid.*
- *Convenient removable funnel to add liquid ingredients during processing.*
- *Stainless steel worm, head and ring.*
- *Full availability of any kind of dies.*
- *Variable-speed pasta cutter available.*
- *Bowl made of anodized aluminium*
- *IP 54 controls*
- *Forced air-cooling system for heavy-duty use.*



**SINFONIA 2**  
con tagliapasta opzionale  
*optional pasta cutter*

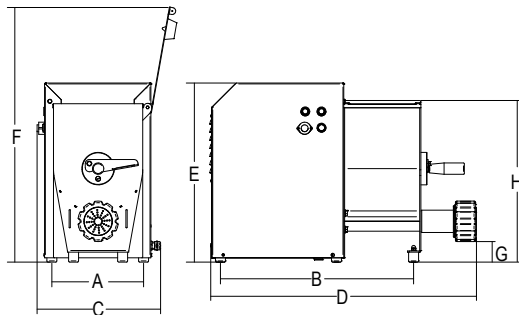

	watt/Hp	lit	kg	kg/h.	ø mm	mm	mm	mm	mm	mm	mm	mm	mm	kg	mm	kg	
						A	B	C	D	E	F	G	H				
<b>Sinfonia 2</b>	370/0.50	1ph	6	2.5	5	60	206	411	263	577	407	489	65	353	28	750x580x800	37

Colore rosso opzionale  
*Optional red colour*





P. 66

# CONCERTO 5

## macchina per la pasta fresca

### pasta machine



- Adatta alle esigenze del medio ristorante.
- Pratica, veloce ed estremamente facile da pulire e sanificare.
- Costruzione in acciaio inox AISI 304.
- Potente motore ventilato con riduzione ad ingranaggi a bagno d'olio.
- Performante pala impastatrice facilmente rimovibile.
- Coperchio in acciaio inox interbloccato.
- Pratica e rimovibile tramoggia per versare la parte liquida in modo ottimale.
- Coclea, bocca e ghiera in acciaio inox.
- Vasca in alluminio anodizzato.
- Ampia disponibilità di trafilie in bronzo.
- Motorino tagliapasta con variatore opzionale.
- Comandi in acciaio inox IP 67.
- Sistema di ventilazione forzata temporizzata anche a motore spento.

#### Opzionali:

- Motorino tagliapasta con variatore.
- Kit per trafilie penne.
- Collegabile alla raviolatrice Raviomatic.
- *Designed for medium-duty operations, ideal for medium-size restaurants.*
- *Reliable, user-friendly and easy to clean.*
- *AISI 304 stainless steel body.*
- *Powerful, air-cooled motor with oil bath gear box reducer.*
- *High-performance and easy to remove kneading paddle.*
- *Interlocked stainless steel lid.*
- *Convenient removable funnel to add liquid ingredients during processing.*
- *Stainless steel worm, head and ring.*
- *Bowl made of anodized aluminium.*
- *Full availability of any kind of dies.*
- *Variable-speed pasta cutter available.*
- *IP 67 stainless steel controls.*
- Sistema di ventilazione forzata temporizzata anche a motore spento.

#### Options:

- *Variable-speed pasta cutter.*
- *Optional kit for "penne" die*
- *Can be connected to Raviomatic ravioli maker.*

#### CONCERTO 5

con tagliapasta opzionale  
optional pasta cutter

Kit per trafilie penne opzionale, trafilie a parte  
Optional kit for "penne" die (die not included)

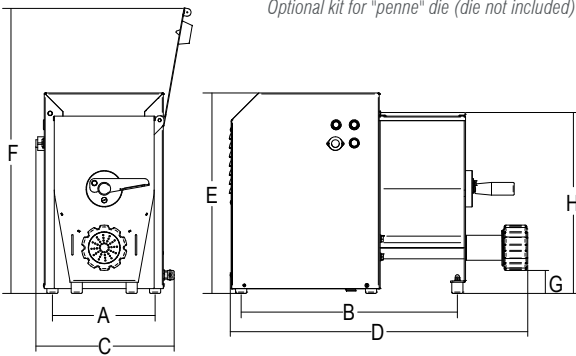

Impasto  
Dough

							A	B	C	D	E	F	G	H			
	watt/HP	lit	kg	kg/h.	ø mm	mm	mm	mm	mm	mm	mm	mm	mm	mm	kg	mm	kg
Concerto 5	750	1ph	10	4	8	70	226	476	305	665	442	630	50	391	42	760x640x770	50

Colore rosso opzionale  
Optional red colour





# SIRPASTA XP

## macchine per la pasta fresca *pasta machine*

- Impasto facile e veloce con il sistema spirale planetaria.
- Capienza vasca 20 Lt per un impasto da 4.2 Kg (3 Kg farina + 1.2 Kg uova).
- Vasca e spirale facilmente smontabili per pulizia e sanificazione.
- Efficiente motore ventilato assicura una produttività costante e continua
- Pulsanti inox IP 67
- Coperchio con interblocco di sicurezza
- Coclea inox e corpo trafilatura in bronzo al nickel.
- Trafilatura in bronzo con ampia disponibilità di formati.
- Motorino tagliapasta a velocità variabile opzionale.
- Collegabile con raviolatrice RAVIOMATIC

- *Planetary spiral mixer for easy and fast dough mixing.*
- *Tank capacity 20 Lt for a mix of 4.2 Kg (3 Kg flour + 1.2 Kg eggs).*
- *Bowl and spiral easily removable for cleaning and sanitizing.*
- *Efficient, fan-cooled motor ensures constant, non-stop productivity.*
- *IP 67 stainless steel buttons.*
- *Lid with safety interlock device.*
- *Stainless steel worm and nickel bronze extruder head.*
- *Bronze die with large availability of pasta shapes.*
- *Optional, variable-speed pasta cutter motor.*
- *Can be connected to RAVIOMATIC ravioli maker.*



P. 66

















Impasto  
*Dough*



Chiusura bocca per impasto  
*Gate closure for mixing*



Trafile/Dies

					
n. 9 Spaghetti mm 1,9	n. 13 Bigoli / Pici Toscani mm 3	n. 21 Linguine mm 3x1,6	n. 25 Spaghetti quadri mm 2	n. 32 Tagliolini mm 3,5	n. 34 Tagliatelle mm 6
					
n. 38 Pappardelle mm 15	n. 77 Maccheroni rigati mm 8	n. 91 Gramigne mm 3	n. 191 Gnocchetti sardi mm 19	n. 220 Caserecce Strozzapreti mm 19	n. 240 Fusilli mm 8,4
					
n. 116 (*) Penne	Sfoglia regolabile larghezza sfoglia mm 170 Adjustable sheeter Sheet width mm 170	Kit per trafile penne opzionale, trafile a parte Optional kit for "penne" die (die not included)		(*) Necessita del kit coltello inclinato per penne Requires kit knife inclined for penne	









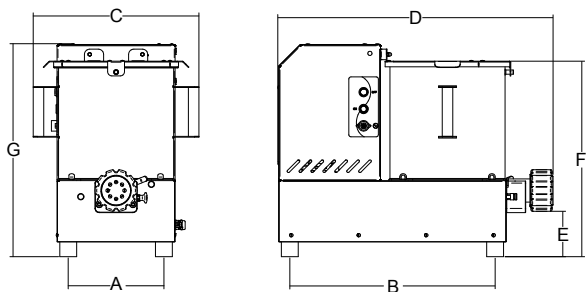







Vaschetta per liquidi opzionale  
Optional liquid distribution hopper



**SIRPASTA XP + RAVIOMATIC**



															
	watt/HP	lit	kg	ø mm	mm	mm	mm	mm	mm	mm	mm	kg	mm	kg	
<b>Sirpasta XP</b>	750/1	1ph	20	4.2	70	227	487	393	653	108	464	505	52	760x640x740	67

# ORCHESTRA 10

## macchina per la pasta fresca *pasta machine*

- Adatta alle esigenze dei piccoli laboratori, grandi ristoranti o mense.
- Pratica, veloce ed estremamente facile da pulire e sanificare.
- Costruzione in acciaio inox AISI 304.
- Struttura autoportante con 4 ruote inox.
- Potente motore ventilato con riduzione ad ingranaggi a bagno d'olio.
- Performante pala impastatrice facilmente rimovibile.
- Coperchio in acciaio inox interbloccato.
- Pratica e rimovibile tramoggia per versare la parte liquida in modo ottimale.
- Coclea, bocca e ghiera in acciaio inox.
- Ampia disponibilità di trafilè in bronzo.
- Comandi in acciaio inox IP 67.
- Sistema di ventilazione forzata temporizzata anche a motore spento.

- *Suitable for small workshops and large restaurants or canteens.*
- *Reliable, user-friendly and easy to clean.*
- *AISI 304 stainless steel body.*
- *Self-supporting structure with 4 stainless steel wheels.*
- *Powerful, air-cooled motor with oil bath gear box reducer.*
- *High-performance and easy to remove kneading paddle.*
- *Interlocked stainless steel lid.*
- *Convenient removable funnel to add liquid ingredients during processing.*
- *Stainless steel worm, head and ring.*
- *Full availability of any kind of dies.*
- *IP 67 stainless steel controls.*
- *Forced air-cooling system for heavy-duty use.*









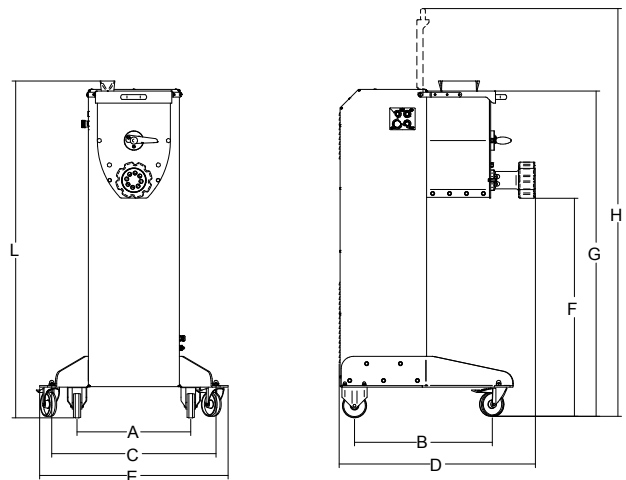











**ORCHESTRA 10**  
con tagliapasta opzionale  
*optional pasta cutter*



P. 66



ORCHESTRA 10 + RAVIOMATIC

																		
	watt/HP	lt	kg	kg/lt.	ø mm	mm	mm	mm	mm	mm	mm	mm	mm	mm	mm	kg	mm	kg
<b>Orchestra 10</b>	1ph 1.875/2.5 3ph 2.250/3	1ph/3ph	21	9.8	-	100	470	570	680	812	780	902	1346	1687	1360	118	940x1055x1550	135



# SIRPASTA MAXI

macchina per la pasta fresca  
*pasta machine*

- Impasto facile e veloce con il sistema spirale planetaria.
- Macchina fornita su mobile con ruote e pratiche guide per posizionare le cassette alimentari cm 60x40x5 con il prodotto lavorato o gli accessori.
- Capacità vasca lt 52.
- 14 Kg di impasto finito (10 Kg farina)
- Coclea e vasca inox, spirale in alluminio, corpo trafila in bronzo
- Vasca, spirale, coclea e bocca di trafilazione facilmente smontabili per pulizia e sanificazione
- Ampia disponibilità di trafilè in bronzo per pasta di diversi formati.
- Coltello taglia pasta motorizzato con regolazione della velocità per il taglio della pasta lunga o corta di serie.
- Accessorio applicabile: Raviolatrice Bologna EL.

• *Spiral planetary motion machine for making fresh pasta and bread.*

*The machine comes on a stand with wheels and a practical guide for positioning the food trays cm 60x40x5 with the finished product or accessories.*

- *bowl capacity lt 52*
- *14 kg of finished dough (10 kg flour)*
- *Auger and stainless steel tray, aluminium spiral, die plate in bronze.*
- *Tray, spiral, auger and die outlet are easily removable for cleaning and sanitizing.*
- *Bronze die plate with many formats available.*
- *Standard equipment includes motorized pasta cutter with speed adjustment for cutting long or short pasta.*
- *Accessory: Bologna EL ravioli maker.*



Impasto  
Dough



Sirpasta Maxi - pasta corta/short











Sirpasta Maxi- pasta lunga/long



Sirpasta Maxi- ravioli





									
	watt/HP	ph	lt	kg	ø mm	mm	kg	mm	kg
<b>Sirpasta Maxi</b>	1.100/15	1ph	52	14	100	800x1080 1515	202.5	-	-



Sirpasta Maxi+ tagliapasta

Sirpasta Maxi+ sfoglia regolabile

Sirpasta Maxi+ BOLOGNA EL



# RAVIOMATIC

## raviolatrice ravioli maker

- Raviolatrice elettrica per ravioli trafilati monosfoglia.
- Pratica, flessibile e veloce.
- Disponibili diversi stampi per forma e dimensione.
- Facilmente smontabile in ogni componente a contatto con il prodotto per una efficiente e veloce pulizia.
- Pratico sistema per la regolazione della quantità di ripieno.
- La motorizzazione indipendente con variazione di velocità, si adatta ad ogni tipo di macchina dalle elevate prestazioni.
- Disponibili trafilte per diversi spessori sfoglia.

- *Electric ravioli maker for single-layer extruded ravioli.*
- *Practical, flexible and fast.*
- *Comes with moulds of different shapes and sizes.*
- *Each component in contact with the pasta can be easily dismantled for efficient and rapid cleaning.*
- *Practical system for adjusting the amount of filling.*
- *Variable-speed independent motor that adapts to any type of machine with high performance.*
- *Comes with various dies for different sheet thicknesses.*



### Stampo ravioli opzionale Optional ravioli mold



Ravioli Piemontesi (Plin)



Ravioli Mezza Luna lisci  
mm 50x31  
mm 72x49



Ravioli Mezza Luna  
mm 50x31  
mm 72x49



Ravioli Rettangolari  
mm 50x42  
mm 70x50



Ravioli Triangolari  
mm 60x60

Ravioli Quadrati  
mm 37x37

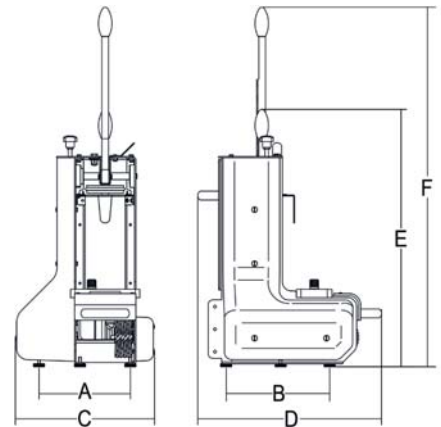

	watt/HP	ph	mm	mm	mm	mm	mm	mm	kg	mm	kg
<b>Raviomatic</b>	100/0,14	1ph	203	230	309	408	572	800	19,5	-	-



# i2PASTA

## Accessorio per produzione pasta Pasta extruder attachment



- Un invito alla pasta fatta in casa, un primo approccio al gustoso e affascinante mondo della pasta fresca.
- i2Pasta (Invitation To Pasta!) è un accessorio adattabile a tutte le planetarie con una presa di forza "tipo 12"
- Utilizza trafile standard in bronzo da 70 (utilizzate anche su Concerto e Sirpasta).
- Bocca totalmente in acciaio inox AISI 304 lavabile in lavastoviglie.
- Disponibile motorino tagliapasta indipendente per pasta corta.
- Perfetto connubio con Plutone 30 alla prima velocità.

- An invitation to make homemade pasta, an introduction to the savoury and fascinating world of fresh pasta.
- i2Pasta (Invitation To Pasta!) is an accessory that adapts to all planetary mixers with "type 12" power drive.
- Uses standard size-70 bronze dies (also used on Concerto and Sirpasta).
- Dishwasher safe mouth made entirely of Grade AISI 304 stainless steel.
- Available with independent pasta cutting motor for short pasta.
- Ideally combined with Plutone 30 at the first speed.



P. 256



i2Pasta



Pasta lunga  
Long pasta



P. 61



Pasta corta / Tagliapasta opzionale  
Short pasta / Optional pasta cutter



# COMO

## sfogliatrice automatica automatic sheeter

- Macchina sfogliatrice che sfrutta il principio delle gramole tipico delle soluzioni industriali, per produrre la sfoglia in una sola passata.
  - Struttura in acciaio inox.
  - Motore da 0,37 Kw, 4 poli.
  - Peso netto kg 15.
  - Gruppo sfoglia in alluminio, rulli in acciaio.
  - Ampia tramoggia di carico della pasta.
  - Motore potente e ventilato.
  - Regolazione dello spessore della sfoglia.
  - Larghezza sfoglia mm 120.
  - Sfogliatrice apribile per una facile e rapida pulizia.
  - Cassetto per tagliatelle opzionale da mm 2-5-6-8-10.
- *Sheeter machine that works according to the principle of olive oil machines typical of industrial solutions, to produce the dough in a single run.*
  - *Structure in stainless steel.*
  - *0,37 kW 4 pole motor.*
  - *Net weight: 15 Kg.*
  - *Sheet unit in aluminium, steel rollers.*
  - *Spacious hopper to feed the dough.*
  - *Powerful and ventilated motor.*
  - *Adjustable dough thickness*
  - *Sheet width mm 120.*
  - *The kneading machine can be opened for easy and quick cleaning.*
  - *Optional tray for tagliatelle noodles: size mm 2-5-6-8-10.*

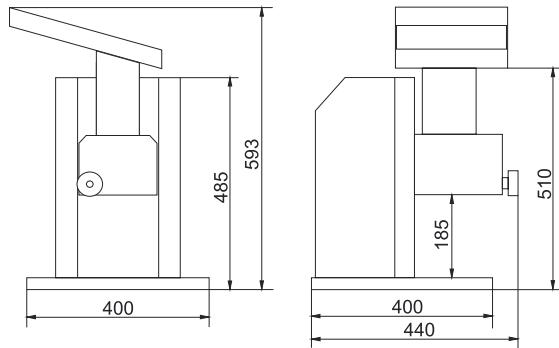



# SANSONE

## tirasfoglia pasta roller



**SANSONE 42**  
Taglierina opzionale  
Optional pasta cutter

- Potente tirasfoglia realizzata in 4 misure.
- Realizzazione verticale che riduce l'ingombro sul tavolo da lavoro e agevola la presa della sfoglia in uscita.
- Costruzione in acciaio inox.
- Motore ventilato a servizio continuo con doppia riduzione.
- Riduttore coassiale + trasmissione a catena.
- Regolazione spessore pasta 0 ÷ 10 mm.
- Protezione zona carico con micro di sicurezza.
- Ampio scivolo di carico sfoglia.
- Applicazione taglierina opzionale in 5 misure, mm 2 - 4 - 6 - 8 - 12.
- Larghezza taglierina mm 165.
- Ideale anche per laminare la pizza.

- Powerful dough roller available in 4 sizes.
- Vertical construction that reduces the space taken up on the working counter and facilitates gripping of the dough at outfeed.
- Built out of stainless steel.
- Ventilated motor in non-stop operating mode with dual reduction.
- Coaxial reduction gear + belt transmission.
- Adjustable dough thickness 0 ÷ 10 mm.
- Infeed area protected with safety microswitch.
- Wide chute for dough infeed.
- Application of optional cutter available in 5 sizes, mm 2 - 4 - 6 - 8 - 12.
- Width pasta cutter mm 165.
- Perfect also to laminate pizza.



**SANSONE 52**

**SANSONE 32**

**SANSONE 25**



Protezione mani  
Hand protection

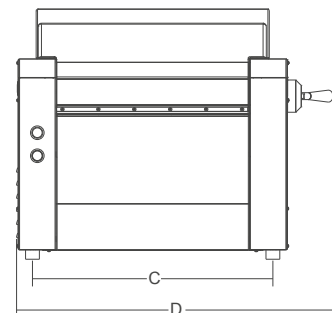
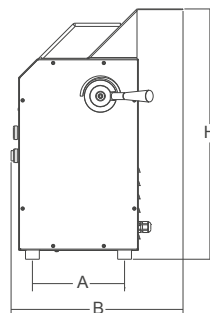

	watt/Hp	ph/3ph	mm	mm	mm	mm	mm	mm	kg	mm	kg
<b>Sansone 25</b>	270/0.37	1ph/3ph	ø 60x250	200	375	352	515	545	30	760x640x800	43
<b>Sansone 32</b>	370/0.5	1ph/3ph	ø 60x320	200	375	422	600	545	52	760x640x800	65
<b>Sansone 42</b>	370/0.5	1ph/3ph	ø 60x420	200	375	522	700	545	59	760x640x800	72
<b>Sansone 52</b>	370/0.5	1ph/3ph	ø 60x520	200	375	622	800	545	66	760x640x800	79



# TM2

## tagliaverdure vegetable cutters



- Realizzazione in lega di alluminio e acciaio inox.
- Motore ventilato per uso continuo.
- Design estremamente compatto per una migliore gestione degli spazi in cucina.
- L'esclusivo sistema a caduta diretta del prodotto permette di lavorare anche prodotti morbidi e delicati come mozzarella e altri formaggi.
- Sicurezza garantita da 3 microinterruttori: su leva, coperchio e vasca.
- Vasca raccoglifette con interblocco in dotazione.
- Disponibile con coperchio inox lavabile in lavastoviglie.
- Ampia disponibilità di dischi per tutte le applicazioni.

- Aluminium alloy and S/S construction.
- Ventilated motor for continuous operation.
- Thanks to its compact design the machine is easy to install inside every kitchen.
- The exclusive feeding system makes easy to process also soft products like mozzarella cheese.
- Safe operation is ensured by interlock switches on product pusher, lid and collecting tray.
- Bath collect-interlock provided.
- Version with dishwashing safe S/S lid available.
- Large number of discs available for every purpose.



TM2 INOX



TM2 ALL.

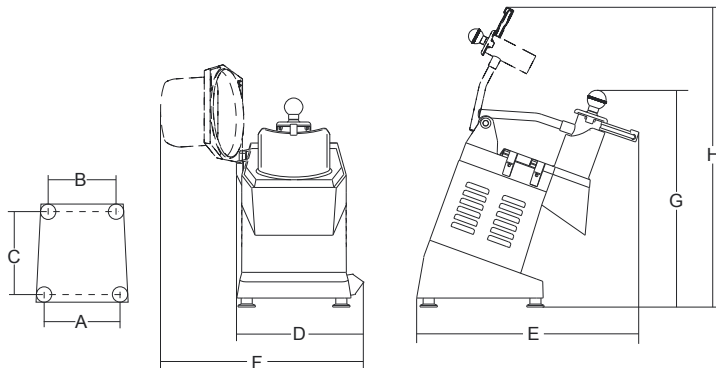

	watt/HP	r.p.m.	mm	mm	mm	mm	mm	mm	mm	mm	mm	kg	mm	kg
<b>TM2 Inox</b>	515/0.7	1ph/3ph	300	225	195	255	280	510	-	510	770	17.5	720x350x500	21
<b>TM2 All.</b>	515/0.7	1ph/3ph	300	225	195	255	280	510	400	510	770	18.5	720x350x500	22

Dischi fette DF / slices discs DF

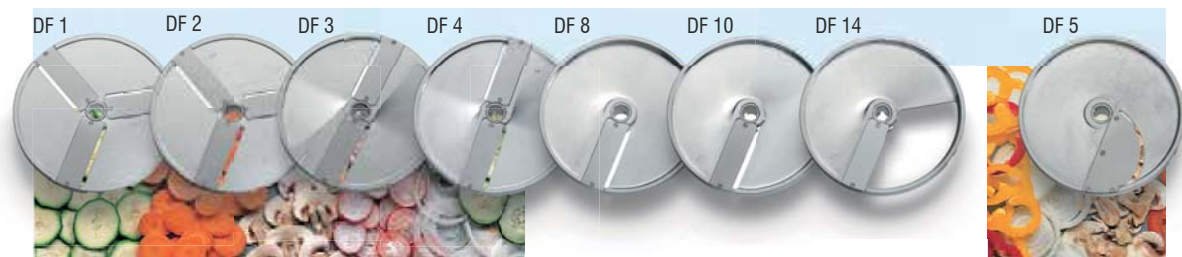

Dischi bastoncini DQ / Discs DQ sticks



Dischi cubetti PS / Dicing discs



Dischi per sfilacciare DT / Discs for shredding DT

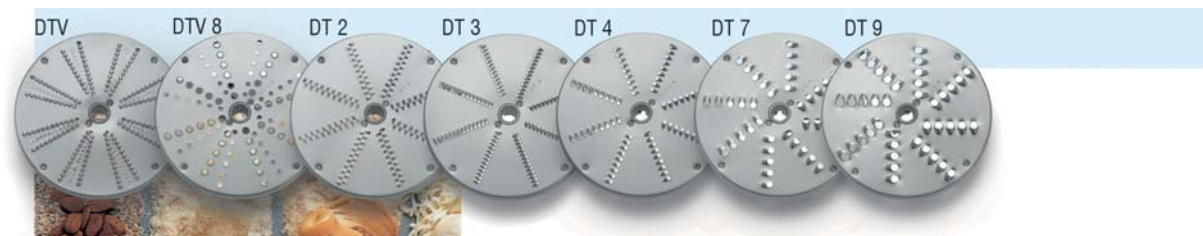

Coperchio in alluminio con apertura laterale.  
Aluminium feed hopper lid with side opening



Scivolo per scarico continuo, con micro di sicurezza.  
Chute for continuous product ejection, with safety microswitch.



Pulsantiera elettronica IP 54  
IP 54 electronic control



Pulitore per dischi PS  
Cleaner for PS discs



Porta dischi  
Discs holder



# TM-TG

## tagliaverdure vegetable cutters



- TM-TG è una versione dello storico TM che, grazie alla nuova tramoggia gigante di introduzione prodotto, sfrutta al massimo la potenza del motore e la solida struttura del TM.
- Caratteristiche funzionali ed elettriche come TM.
- Trasmissione del moto con cinghia dentata.
- Compatibilità tutti dischi TM esclusi i PS che sono dedicati.
- Coperchio alluminio-inox con carico a 360°.
- Leveraggio per sollevamento e rotazione pressore con micro.
- Tubo introduzione senza micro.
- Esclusivo disegno della tramoggia per eliminare vite rompitorolo centrale sul disco.
- GRANDE FACILITA' DI CARICO.
- *TM-TG is a version of the well-known TM that thanks to a new larger feed hopper maximizes the motor power and strong structure.*
- *Same operational and electrical features of the TM .*
- *Positive drive belt.*
- *TM discs compatible, except PS discs .*
- *Aluminum-Stainless steel top with 360° loading feature.*
- *Microswitch on lever.*
- *without introducing the micro tube.*
- *Exclusive hopper design with no central chopping wedge.*
- **VERY EASY PRODUCT LOADING.**

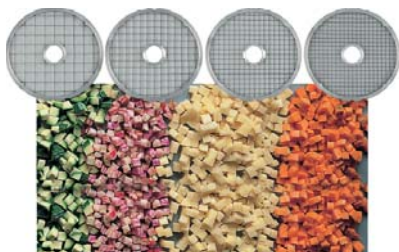

Dischi PS specifici per TM-TG  
Discs specific for PS TM-TG

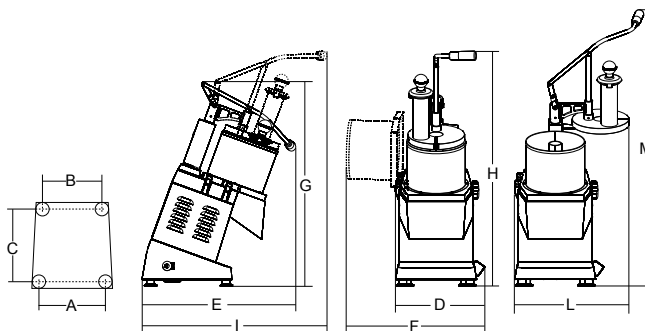

				<b>A</b>	<b>B</b>	<b>C</b>	<b>D</b>	<b>E</b>	<b>F</b>	<b>G</b>	<b>H</b>	<b>I</b>	<b>L</b>	<b>M</b>			
	watt/Hp	r.p.m.		mm	mm	mm	mm	mm	mm	mm	mm	mm	mm	mm	kg	mm	kg
<b>TM-TG</b>	515/0.7	1ph/3ph	300	225	195	255	296	509	460	676	777	612	428	915	20	720x350x800	24







# BLITZ

## cutter

### bowl cutter



- Basamento e vasca in ABS termoresistente
- Coperchio in policarbonato con foro per l'aggiunta di ingredienti durante la lavorazione
- Coperchio e vasca interbloccati ma facilmente smontabili per le operazioni di pulizia
- Freno motore
- Comandi con NVR, 24 Volt, IP 67

#### In dotazione:

- Mozzo con coltelli in acciaio inox
- Mozzo per montare in ABS
- Paletta

#### Opzionale

- Pala raschiatrice smontabile

- *Base-plate and reservoir in heat-resistant ABS*
- *Lid in polycarbonate with hole to add the ingredients during processing*
- *Interlocked lid and reservoir, easy to disassemble though for cleaning*
- *Motor brake*
- *Control with NVR, 24 Volt, IP 67.*

#### Included items:

- *Hub with cutting knives in stainless steel*
- *Hub for ABS assembly*
- *Scoop*









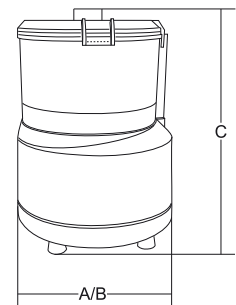

#### Optional

- *Dismountable scraping blade*



Pala raschiatrice smontabile, opzionale  
Optional dismountable scraping blade



										
	watt/HP	1ph	lt	r.p.m.	mm	mm	mm	kg	mm	kg
<b>Blitz</b>	370/0.50	1ph	3.2	2800	240	240	355	8	337x435x275	9



# CUTTER

## cutter bowl cutter

- Robusta struttura in acciaio inox AISI 430.
  - Motore e vasca affiancati che permettono di isolare dal calore il prodotto lavorato (non su C15 da pavimento).
  - Vasche in acciaio inox con fondo termico e manici.
  - Motori ventilati ad alto rendimento per uso continuo.
  - Robusti coltelli a lame curve in acciaio temprato da coltelleria.
  - Sicurezza garantita da un sistema a doppio microinterruttore sul coperchio.
  - Coperchio in Lexan trasparente che permette ottima visibilità durante la lavorazione.
  - Foro di aggiunta ingredienti su coperchio.
  - **Variotronic**: variatore di velocità stabilizzato con controllo di potenza.
  - Modelli C4-6-9 disponibili con variatore continuo di velocità (di serie su C9).
  - Modello C15 da banco disponibile con 2 velocità.
  - Modello C15 Hp 7 con variatore ad inverter di serie.
  - In dotazione: spatola e piastra affilatura lame.
  - Opzionali mozzi con lame: dentate, forate, per pesto, per impasti.
- *Strong AISI 430 steel construction.*
  - *Detached motor and bowl for a better thermal insulation.*
  - *S/S bowl with handles and heavy bottom.*
  - *High efficiency ventilated motor for continuous operation*
  - *Strong cutlery steel knives.*
  - *Safe operations ensured by a system of micro switches on the lid.*
  - *See-through lexan lid.*
  - *Lid with opening to add ingredients during operation.*
  - **Variotronic**: speed control with stabilizer.
  - *C4, C6 and C9 available with steplessly variable-speed drive.*
  - *C15 available with 2 speeds.*
  - *C15 HP7 with steplessly variable-speed drive and inverter as a standard.*
  - *Standard: spatula and sharpening stones.*
  - *Optional: serrated knives, emulsifying knives, knives for pesto sauce and knives to mix dough.*



C6 VV

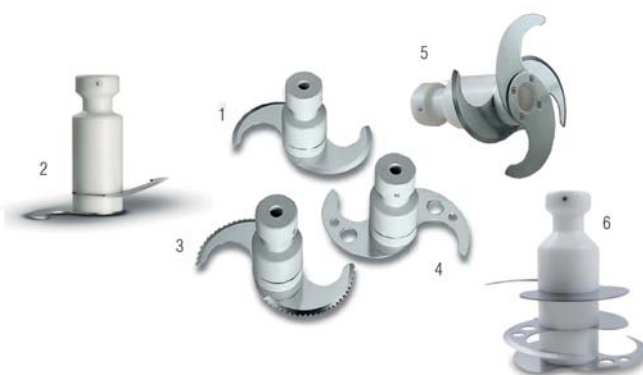

C4

Spatola e piastra affilatura lame di serie  
*Spatula and blade sharpener plate*

1. Lame di serie

Optional

2. Lame per impasto

3. Lame dentate

4. Lame forate

5. Lame pesto

6. Lame pesto per C15



C15



C15 DA BANCO



C9 VV



C4 - C6



C4 VV - C6 VV - C9 VV



C4 - C6 VT (Variotronic)



C15



**VARIOTRONIC™**  
SYSTEM

Variatore di velocità stabilizzato con controllo di potenza  
Speed control with stabilizer



Vasca in acciaio inox 18/10 con fondo termodiffusore facile da svuotare e da pulire  
Stainless steel 18/10 bowl with thermal diffuser bottom, easy to empty and to clean

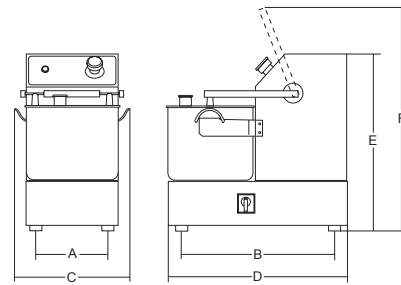
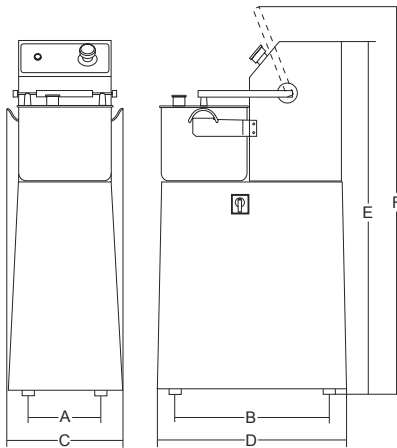

	watt/Hp		lt	lt	r.p.m.	mm	mm	mm	mm	mm	mm	kg	mm	kg
<b>C4</b>	350/0.5	1ph	3.3	1.5	2500	160	310	305	365	255	-	10	450x330x310	11
<b>C4 VV</b>	350/0.5	1ph	3.3	1.5	1500+2500	160	310	305	365	255	-	10	450x330x310	11
<b>C4 VT</b>	350/0.5	1ph	3.3	1.5	600+2800	160	310	305	365	255	-	10	450x330x310	11
<b>C6</b>	350/0.5	1ph	5.3	3.1	2500	160	310	305	365	320	-	11	450x330x400	12
<b>C6 VV</b>	350/0.5	1ph	5.3	3.1	1500+2500	160	310	305	365	320	-	11	450x330x400	12
<b>C6 VT</b>	350/0.5	1ph	5.3	3.1	600+2800	160	310	305	365	320	-	11	450x330x400	12
<b>C9 VV</b>	350+350 0.5+0.5	1ph	9.4	5.4	1500+2500	225	410	355	455	380	-	23	720x350x500	25
<b>C15 da Banco</b>	2.940/4	3ph	14.5	8.2	2800	265	480	380	610	530	700	52	720x570x770	67
<b>C15 2V Banco</b>	1.470/2.200 2+3	3ph	14.5	8.2	1400/2800	265	480	380	610	530	700	52	720x570x770	67
<b>C15</b>	2940/4	3ph	14.5	8.2	2800	340	400	420	445	1030	1130	66	600x600x1150	75
<b>C15 2V</b>	1.470+2.200 2+3	3ph	14.5	8.2	1400/2800	340	400	420	445	1030	1130	66	600x600x1150	75
<b>C15 Macelleria / For meat</b>	2.940/4	3ph	14.5	8.2	2800	340	400	420	445	1030	1130	66	600x600x1150	75
<b>C15 Pasticceria / For thick mixes</b>	5.150/7	3ph	14.5	8.2	1200+1800	340	400	420	445	1030	1130	66	600x600x1150	75



# C-TRONIC

cutter

*bowl cutter*

- Robusta struttura in alluminio pressofuso ed estruso.
- Motore e vasca affiancati che permettono di isolare dal calore il prodotto lavorato.
- Vasche in acciaio inox con fondo termico e manici.
- Motori ventilati ad alto rendimento per uso continuo.
- Robusti coltelli a lame curve in acciaio temprato da coltelleria.
- Microinterruttore di sicurezza su coperchio.
- Microinterruttore su leva.
- Coperchio in Tritan trasparente che permette ottima visibilità durante la lavorazione.
- Foro di aggiunta ingredienti su coperchio.
- Variatore continuo di velocità di serie.
- In dotazione: spatola e piastra affilatura lame.

- *Sturdy body in die-cast and extruded aluminium.*
- *Motor and tank side-by-side, allowing the product to be isolated from the heat.*
- *S/S bowl with handles and heavy bottom.*
- *High efficiency ventilated motor for continuous operation*
- *Strong cutlery steel knives.*
- *Safety micro-switch on lid.*
- *Micro-switch on lever.*
- *Lid in transparent Tritan allowing excellent visibility during processing.*
- *Lid with opening to add ingredients during operation.*
- *Standard speed control*
- *Standard: spatula and sharpening stones.*



**C-TRONIC 9 PLUS**

**Versione:**

- **Variotronic:** variatore di velocità stabilizzato.
- **C-Tronic 9 Plus:**
  - Potente motore asincrono con inverter per un controllo della potenza a tutti i regimi di giri.
  - Velocità di lavorazione fino a 3.500 g/m.
  - Mozzo coltelli in acciaio inox.
  - Spatola raschiatrice per la pulizia di vasca e coperchio durante la lavorazione.

**Opzionali:**

- Mozzo con lame dentate.
- Mozzo con lame forate.
- Mozzo per pesto.
- Mozzo per impasti.
- Spatola raschiatrice per la pulizia di vasca e coperchio durante la lavorazione.

**Version:**

- **Variotronic:** stabilised speed variator.
- **C-Tronic 9 Plus:**
  - Asynchronous motor with inverter for adjusting the power at all speeds.
  - Processing speed up to 3,500 g / m.
  - Knife hub in stainless steel.
  - Scraper spatula for cleaning the tank and lid during processing.

**Options:**

- Hub with toothed blades.
- Hub with holed blades.
- Hub for pesto.
- Hub for dough mixes.
- Scraper spatula for cleaning the tank and lid during processing.



**C-TRONIC 4 VT**



Comandi  
Controls



**Variotronic:** variatore di velocità stabilizzato.  
**Variotronic:** stabilised speed variator.



Spatola raschiatrice per la pulizia di vasca e coperchio durante la lavorazione  
Scraper spatula for cleaning the tank and lid during processing



C-TRONIC 6 VT

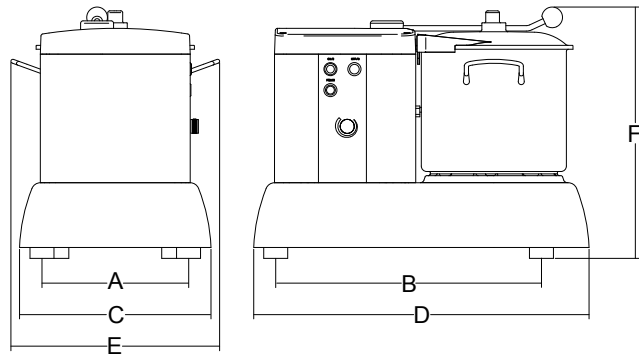

	watt/HP	1ph	lt	lt	r.p.m.	mm	mm	mm	mm	mm	mm	kg	mm	kg
<b>C-Tronic 4 VT</b>	350/0.5	1ph	3.3	1.5	600+2800	185	369	251	457	296	300	-	-	-
<b>C-Tronic 6 VT</b>	350/0.5	1ph	5.3	3.1	600+2800	185	369	251	457	304	362	-	-	-
<b>C-Tronic 9 VT</b>	350+350 0.5+0.5	1ph	9.4	5.4	600+2800	244	443	319	560	348	420	-	-	-
<b>C-Tronic 9 Plus</b>	1.100/1.5	1ph	9.4	5.4	600+3500	244	443	319	560	348	420	-	-	-



# ATHOS

## tagliamozzarella mozzarella cutter

- Macchina robusta, compatta, costruita in acciaio inox e alluminio anodizzato.
  - Campana porta dischi in alluminio lucidato, completamente smontabile per la pulizia;
  - Lame e dischi in acciaio da coltelleria e alluminio;
  - Tramoggia in acciaio inox;
  - Trasmissione a cinghia piatta PoliV;
  - Protezione su bocca campana in ABS con micro magnetico;
  - Pulsantiera elettronica a 24 V con dispositivo NVR.
- *Strong compact heavy-duty grater, made of stainless steel and anodized aluminium.*
  - *Polished aluminium disc holder is completely removable for cleaning.*
  - *Cutlery steel and aluminium grating discs.*
  - *Stainless steel tray.*
  - *Poly-V belt drive.*
  - *Guard on disc holder opening.*
  - *24 V electronic push-button panel with NVR.*



Dischi rimovibili  
Removable discs



Protezione su bocca campana in ABS con micromagnete.  
Guard on disc holder opening.



Protezione inferiore  
Bottom shield



Dischi intercambiabili  
Exchangeable discs

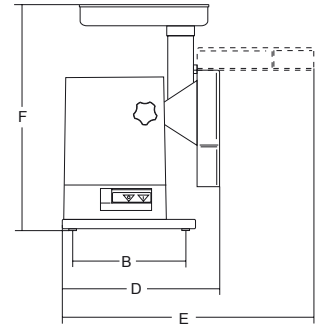
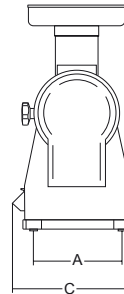

				<b>A</b>	<b>B</b>	<b>C</b>	<b>D</b>	<b>E</b>	<b>F</b>			
	watt/HP	1ph/3ph	r.p.m.	mm	mm	mm	mm	mm	mm	kg	mm	kg
<b>Athos</b>	210/0.30	1ph/3ph	400	150	260	230	370	570	480	14	500x300x550	17



# STORM

## frullatori ad immersione hand-held mixers



- Efficiente sistema di raffreddamento del motore per un utilizzo prolungato
  - Robusta ma leggera struttura portante in ABS caricato a vetro
  - Pratica ed ergonomica impugnatura
  - Macchina protetta con grado IP x3
  - Rapido sistema di aggancio asta
  - Coltello a tre lame in acciaio da coltelleria
- *Highly effective cooling system.*
  - *Sturdy, lightweight ABS frame Glass Filled*
  - *Practical and ergonomic handle*
  - *The machine is protected with IPX3*
  - *Quick coupling system*
  - *Three steel knife blades cutlery*

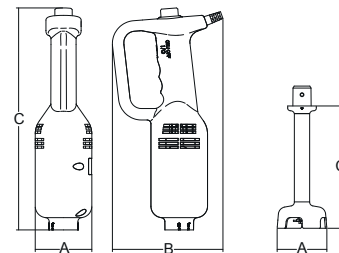

	watt/Hp	1ph	r.p.m.	lt	mm	mm	mm	kg	mm	kg
<b>Storm</b>	200/0.27	1ph	12500	15	74	145	290	1.1	225x560x140	2
<b>Storm VV</b>	200/0.27	1ph	2.000÷12.500	15	74	145	290	1.1	225x560x140	2
<b>Asta 16</b>	-	-	-	-	ø 65	-	160	0.2	-	-



Pratico sgancio asta  
Shaft easy to remove



# CICLONE

## frullatori a immersione hand-held mixers



- Efficiente sistema di raffreddamento motore
- Robusta ma leggera struttura portante in ABS caricato a vetro
- Pratica ed ergonomica impugnatura
- Disponibile con velocità fissa o variabile
- Sistema di sicurezza contro l'accensione accidentale
- Pulsante di bloccaggio motore acceso
- Disponibili in 3 diverse motorizzazioni
- Macchina protetta con grado IP x3
- Rapido sistema di aggancio asta
- Disponibili aste da 25 e 35 cm
- Coltello a tre lame in acciaio da coltelleria
- Optional: supporto pentola, supporto a muro, frusta.
- Frusta con sistema di ingranaggi in metallo
- Fruste inox smontabili e pulibili in lavastoviglie.

- Efficient motor cooling system
- Sturdy, lightweight ABS frame Glass Filled
- Practical and ergonomic handle
- Available with fixed or variable speed
- safety system against accidental activation
- of Trigger switch
- Available in 3 different engines
- The machine is protected with IPX3
- Quick coupling system
- Shafts available in 25 and 35 cm
- Three steel knife blades cutlery
- Optional: Pot support, wall attachment, whisk.
- Whisk with metal gearing
- Whips Demountable and in the dishwasher.



CICLONE 36



ASTA 25  
SHAFT 25

ASTA 35  
SHAFT 35

FRUSTA  
WHISK

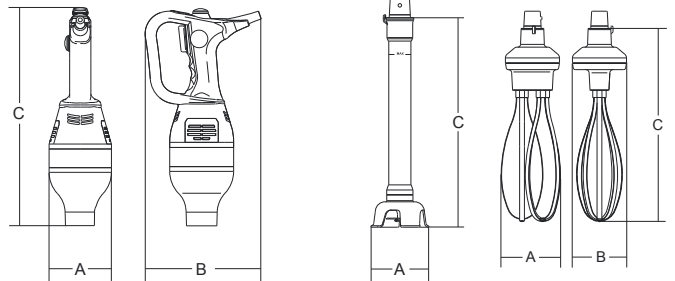

	watt/HP	ph	r.p.m.	r.p.m.	lit	mm	mm	mm	mm	kg	mm	kg
<b>Ciclone 20</b>	200/0.27	1ph	2.300	12.000	20	100	182	340	2	440x330x150	3	
<b>Ciclone 20 VV</b>	200/0.27	1ph	1.900÷2.700	1.000÷12.000	20	100	182	340	2	440x330x150	3	
<b>Ciclone 28</b>	280/0.38	1ph	2.300	12.000	40	100	182	340	2.2	440x330x150	3.2	
<b>Ciclone 28 VV</b>	280/0.38	1ph	1.900÷2.700	1.000÷12.000	40	100	182	340	2.2	440x330x150	3.2	
<b>Ciclone 36</b>	360/0.50	1ph	2.300	12.000	70	100	182	348	2.5	440x330x150	3.5	
<b>Ciclone 36 VV</b>	360/0.50	1ph	1.900÷2.700	1.000÷12.000	70	100	182	348	2.5	440x330x150	3.5	
<b>Asta 25</b>	-	-	-	-	-	ø 94	-	250	0.5	-	-	
<b>Asta 35</b>	-	-	-	-	-	ø 94	-	320	0.7	-	-	
<b>Frusta</b>	-	-	-	-	-	106	113	348	1.1	520x210x250	2	



Coltelli smontabili  
Removable knives

Asta smontabile  
Removable shafts



CICLONE 28



CICLONE 36





## VORTEX

### frullatori a immersione hand-held mixers

- Efficiente sistema di raffreddamento motore.
- Robusta ma leggera struttura portante in ABS caricato a vetro.
- Pratica ed ergonomica impugnatura.
- Paracolpi in gomma per attutire il contatto con i recipienti.
- Motori potenti e prestanti.
- Disponibile in tre versioni di comandi:
  - Velocità fissa.
  - Velocità variabile al dito.
  - **Variotronic**: variatore di velocità stabilizzato con controllo di potenza.
- Sistema di sicurezza contro l'accensione accidentale.
- Pulsante di bloccaggio motore acceso.
- Disponibili in 3 diverse motorizzazioni.
- Macchina protetta con grado IP x3.
- Rapido sistema di aggancio asta.
- Aste totalmente smontabili per una pulizia approfondita che ne prolunga la durata.
- Mozzo e campana completamente in acciaio inox.
- Frusta con sistema di ingranaggi in metallo.
- Fruste inox smontabili e pulibili in lavastoviglie.

#### Opzionali:

- Valigetta.
- Supporto pentola.
- Supporto a muro.
- Espositore.



Espositore inox per Vortex e Ciclone  
Display stand for Vortex and Cyclone



VORTEX 43

- Efficient engine cooling system.
- Sturdy, lightweight ABS frame Glass Filled.
- Practical and ergonomic handle.
- Rubber bumpers to cushion contact with the containers.
- powerful performance engines.
- Available in three versions of commands:
  - Fixed speed.
  - Variable speed on his finger.
  - **Variotronic**: speed control with stabilizer.
- safety system against accidental ignition.
- the Trigger switch.
- Available in 3 different engines.
- The machine is protected with IPX3.
- Quick coupling system.
- totally removable rods for a thorough cleaning which extends their life.
- Hub and completely in stainless steel bell.
- Whisk with metal gearing.
- Whips Demountable and in the dishwasher.

#### Options:

- Storage case.
- Bowl support.
- Wall support.
- Display stand.



FRUSTA  
WHISK

ASTA 35  
SHAFT 35

ASTA 45  
SHAFT 45



VORTEX 75



VORTEX 55



Sgancio frusta  
*Whisk release*



Supporto a muro opzionale  
*Optional wall support*



Supporto pentola opzionale  
*Optional bowl support*



Impugnatura ergonomica  
*Ergonomic handle*



Dispositivo di sicurezza per l'accensione  
*Safety device for the machine switch on*



Variatore di velocità con stabilizzatore Variotronic  
*Variotronic speed control with stabilizer.*



Griglie di ventilazione IP x3  
*Air intake IP x3*



Aggancio rapido utensili  
*Quick tool assembly*



Campana e coltelli inox  
*Bell and knives of stainless steel*



Variatore di velocità stabilizzato con controllo di potenza  
*Speed control with stabilizer*



Coltelli smontabili  
Removable knives

Asta smontabile  
Removable shafts

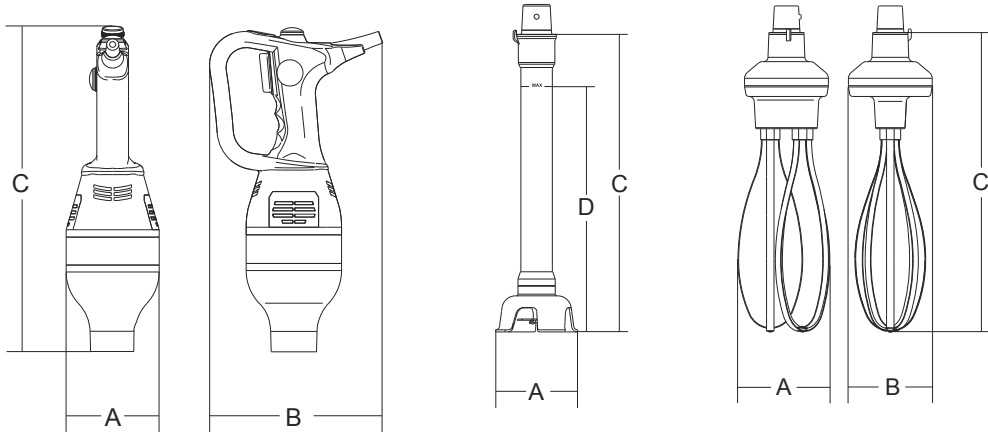

						<b>A</b>	<b>B</b>	<b>C</b>	<b>D</b>			
	watt/Hp	1ph	r.p.m.	r.p.m.	lt	mm	mm	mm	mm	kg	mm	kg
<b>Vortex 43</b>	430/0.60	1ph	1800	12.500	100	125	190	377	-	2.5	230x270x430	3
<b>Vortex 43 VV</b>	430/0.60	1ph	400÷1.800	0÷12.500	100	125	190	377	-	2.5	230x270x430	3
<b>Vortex 43 VT</b>	430/0.60	1ph	-	2.000÷11.500	100	125	190	377	-	2.5	230x270x430	3
<b>Vortex 55</b>	550/0.80	1ph	1800	13000	200	125	190	385	-	3.5	230x270x430	3.7
<b>Vortex 55 VV</b>	550/0.80	1ph	400÷1.800	0÷13.000	200	125	190	385	-	3.5	230x270x430	3.7
<b>Vortex 55 VT</b>	550/0.80	1ph	-	2.000÷11.500	200	125	190	385	-	3.5	230x270x430	3.7
<b>Vortex 75</b>	750/1	1ph	1800	13000	300	125	190	390	-	4	230x270x430	4.5
<b>Vortex 75 VV</b>	750/1	1ph	400÷1.800	0÷13.000	300	125	190	390	-	4	230x270x430	4.5
<b>Vortex 75 VT</b>	750/1	1ph	-	2.000÷11.500	300	125	190	390	-	4	230x270x430	4.5
<b>Asta 35</b>	-	-	-	-	-	∅ 100	-	415	350	1.2	490x230x150	1.8
<b>Asta 45</b>	-	-	-	-	-	∅ 100	-	515	450	1.6	590x230x150	2.1
<b>Frusta</b>	-	-	-	-	-	117	113	385	-	1.2	520x210x250	1.6



# PPJ - LCJ

pelapatate - lavacozze  
 potato peelers - mussels cleaner

- Costruzione in acciaio inox AISI 304.
  - Sistema di trasmissione con cinghia poliV autotensionante.
  - Potenti motori ventilati per uso continuo.
  - Fondello abrasivo in inox bugnato.
  - Pareti abrasive PP con mantello facilmente sostituibile dall'operatore.
  - Vasca e fondello abrasivo facilmente asportabili senza attrezzi e lavabili in lavastoviglie (brevettato).
  - Sistema di scarico patate automatico.
  - Bocca di scarico in acciaio inox con fissaggio rapido e chiusura ermetica.
- 
- *AISI 304 stainless steel body.*
  - *transmission system with self-tensioning belt Poliv.*
  - *High efficiency ventilated motors for continuous operation.*
  - *stainless peeling disc.*
  - *PP abrasive walls with easily replaceable mantle by the operator.*
  - *Bath and easily removable bottom peeling without tools and dishwasher safe (patented).*
  - *exhaust system automatically potatoes.*
  - *exhaust vent in stainless steel with quick and sealed locking.*



PPJ 10



PPJ 20

## PPJ - LCJ

- Piedini inox regolabili e fissabili a pavimento.
- Facile manutenzione per accesso immediato a tutti i componenti senza ribaltare la macchina.

### Versioni a due velocità (solo versione 10):

- Pelapatate/Lavacozze (PP/LC) necessita due vasche.
- Pelapatate/Asciugaverdura (PP/AV) necessita cestello opzionale.

### Versione CE con:

- Microinterruttore su coperchio
- Microinterruttore su sportello scarico

## PPJ - LCJ

- *Adjustable feet steel and fixed to the floor.*
- *Easy service and easy access to the components.*

### 2 speeds version 10:

- *Potato peeler/shell washer (PP/LC) requires 2 containers.*
- *Potato peeler/vegetable drier (PP/AV) requires optional drier basket.*

### CE version with:

- *Microswitch on the lid*
- *Microswitch on outlet opening*



PPJ 6



PPJ 6



PPJ 10



Cesto asciugaverdura opzionale  
Optional vegetable drier basket



Attacco rapido entrata acqua  
Fast connection/remove of water entry



Cavalletto con filtro opzionale  
Optional trestle with sieve



Convogliatore porta sacchetto opzionale  
Optional longer opening for shopping bags



Comandi inox IP67 PPJ 2V  
PPJ 2V s/steel IP 67 controls

**Opzionali:**

- Convogliatore porta sacchetto.
- Attacco rapido entrata acqua.
- Cavalletto e filtro inox.
- Cesto asciugaverdure

**Options:**

- Longer opening for shopping bags.
- Fast connection/remove of water entry
- S/S trestle and sieve.
- Vegetable drier basket



PPJ6 SC

PPJ 10 SC

PPJ 20 SC

PPJ/LCJ 6

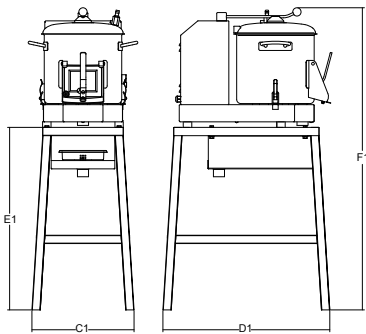

PPJ/LCJ 6

C1 = mm 370  
D1 = mm 600  
E1 = mm 660  
F1 = mm 1090

PPJ/LCJ 6-10-20 SC

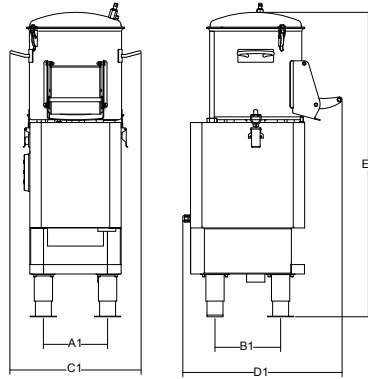

PPJ/LCJ 6 SC

A1 = mm 200  
B1 = mm 240  
C1 = mm 400  
D1 = mm 400  
E1 = mm 790

PPJ/LCJ 10 SC

A1 = mm 225  
B1 = mm 230  
C1 = mm 470  
D1 = mm 544  
E1 = mm 1070

PPJ 20 SC

A1 = mm 330  
B1 = mm 310  
C1 = mm 560  
D1 = mm 650  
E1 = mm 1210

PPJ/LCJ 10-20

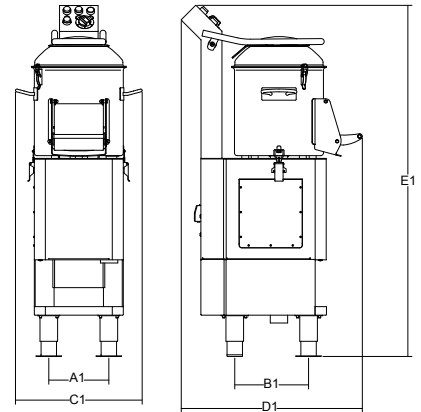

PPJ/LCJ 10

A1 = mm 220  
B1 = mm 270  
C1 = mm 470  
D1 = mm 775  
E1 = mm 1276

PPJ/LCJ 20

A1 = mm 300  
B1 = mm 300  
C1 = mm 560  
D1 = mm 880  
E1 = mm 1360

PPJ/LCJ 10-20

PPJ/LCJ 6-10-20 SC

PPJ/LCJ 6

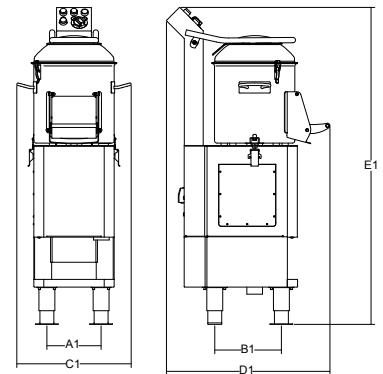
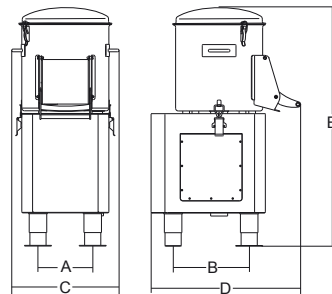
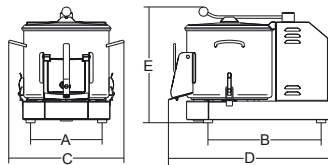

						<b>A</b>	<b>B</b>	<b>C</b>	<b>D</b>	<b>E</b>	<b>F</b>			
	watt/HP		r.p.m.	kg/lt	kg/h	mm	mm	mm	mm	mm	mm	kg	mm	kg
PPJ6 SC	370/0.50	1ph	320	6/10	105	220	260	400	400	690	-	23	720x570x1020	35
PPJ 6	370/0.50	1ph	320	6/10	105	260	320	400	550	440	-	31	500x630x650	36
PPJ 10 SC	735/1	1ph	320	10/20	170	203	282	470	544	910	-	41.5	720x570x1200	51.5
PPJ 10	735/1	1ph/3ph	320	10/20	170	203	282	470	775	1050	1310	51	720x570x1200	61
PP/LCJ 10 2V	368-662/0.50-0.90	3ph	160/320	10/20	170	203	282	470	775	1050	1310	52	720x570x1200	62
PP/AVJ 10 2V	368-552/0.50-0.75	3ph	320/450	10/20	170	203	282	470	775	1050	1310	52	720x570x1200	62
PPJ 20 SC	1.102/1.5	1ph/3ph	275	20/35	340	295	337	560	650	1040	-	52	640x760x1400	62
PPJ 20	1.102/1.5	1ph/3ph	275	20/35	340	295	337	560	880	1190	1545	58	640x760x1400	68
LCJ 6 SC	370/0.50	1ph	150	6/10	150	220	260	400	400	690	-	23	720x570x1020	35
LCJ 6	370/0.50	1ph	150	6/10	150	260	320	400	550	440	-	31	500x630x650	36
LCJ 10 SC	735/1	1ph/3ph	150	10/20	170	203	282	470	544	910	-	41.5	720x570x1200	61
LCJ 10	735/1	1ph/3ph	150	10/20	170	203	282	470	775	1050	1310	51	720x570x1200	61
LCJ 20	1.102/1.5	1ph/3ph	150	20/35	340	295	337	560	880	1190	1545	58	640x760x1400	68



## GP - GF

### grattugie cheese graters

- Macchine semplici e compatte.
- Costruzione in alluminio pressofuso lucidato.
- Motore ventilato (solo GF).
- Rullo inox, solo su GF.



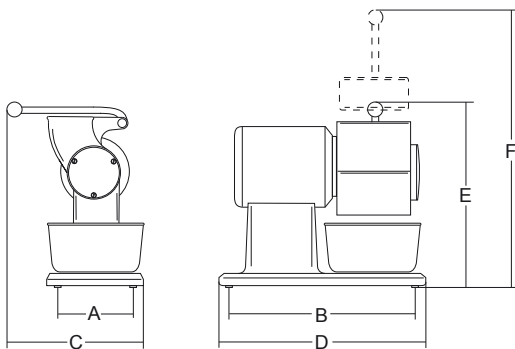



- Simple and compact machines.
- Polished die-cast aluminum construction.
- Ventilated motor (only GF).
- Stainless steel drum, only GF.



Griglia di protezione/rullo inox per GF  
Protection grate/stainless steel drum  
for GF



Microinterruttore su leva  
Micro-switch on lever  
for GF

					<b>A</b>	<b>B</b>	<b>C</b>	<b>D</b>	<b>E</b>	<b>F</b>			
	watt/Hp		r.p.m.	mm	mm	mm	mm	mm	mm	mm	kg	mm	kg
<b>GP</b>	380/0.5	1ph	1.400	110x65	150	220	250	290	310	450	8	430x310x290	10
<b>GF</b>	588/0.8	1ph/3ph	1.400	130x70	185	270	290	390	370	560	16	500x300x550	18



# GF VEGAS - GF DENVER

grattugie  
cheese graters

- Robusta struttura in alluminio anodizzato.
- Motore ventilato.
- Bocca grattugia smontabile in lega di alluminio lucidata e anodizzata.
- Rullo grattugia inox.

**Versione CE con:**

- Microinterruttore di sicurezza su vaschetta raccolta formaggio e leva.
- Comandi IP54 con NVR.

- *Sturdy anodized aluminum frame.*
- *Ventilated motor.*
- *Mouth removable grater aluminum alloy polished and anodised aluminum.*
- *Steel grating roller.*

**CE version with:**

- *Safety microswitches on lever and receiving tray.*
- *IP54 protection rated controls and NVR device.*



GF DENVER

GF VEGAS

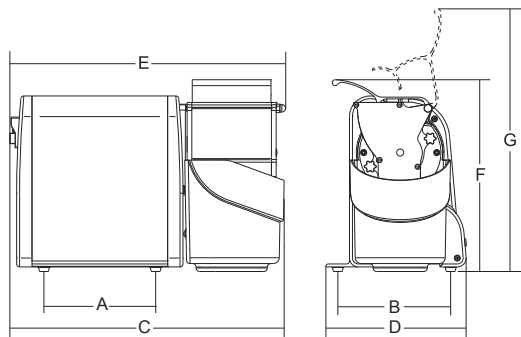

	watt/HP	1ph	r.p.m.	mm	mm	mm	mm	mm	mm	mm	mm	kg	mm	kg
<b>GF Vegas</b>	250/0.3	1ph	1.400	115x65	180	170	442	212	428	302	420	14	400x560x370	18
<b>GF Denver</b>	370/0.5	1ph	1.400	135x65	190	190	465	238	468	325	444	15	620x340x450	19





# GF DAKOTA

## grattugia grater



- Corpo in alluminio anodizzato e fianchi in ABS antiurto.
- Generoso motore ventilato.
- Bocca grattugia in alluminio brillantato di grande capienza.
- Capiente e pratica vasca di raccolta prodotto in plexiglass trasparente.
- Rullo smontabile in acciaio inox.

### Versione CE con:

- Comandi 24 Volt con NVR.
  - Dispositivo di sicurezza su vaschetta raccolta formaggio e leva.
- Anodized aluminum body and ABS shockproof sides.
  - Generous ventilated motor.
  - Mouth Aluminum grater large capacity polished.
  - Capacious and practical bath product collection in transparent plexiglass.
  - Stainless steel separable roller.
- CE version with:**
- 24 volt controls and NVR device.
  - Safety microswitch on the receiving tray and the lever.

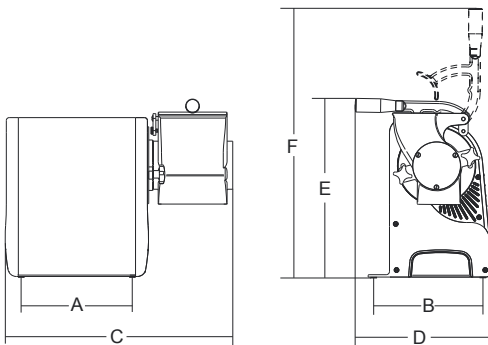

	watt/HP	r.p.m.	mm	mm	mm	mm	mm	mm	mm	kg	mm	kg	
<b>GF Dakota</b>	1ph - 750/1 3ph - 1.100/1,5	1ph/3ph	1.400	140x80	225	215	500	300	400	580	20	630x430x450	22



# GFX-GF

## grattugie cheese graters

### GFX Hp 1.5-2

- Struttura totalmente realizzata in acciaio inox AISI 304.
- Robustezza e facilità di pulizia.
- Potenti motori ventilati per uso continuo.
- Capiente e pratica vasca di raccolta prodotto in plexiglass trasparente (inox opzionale).
- Rullo in acciaio inox.
- Bocca in lega di alluminio brillantata totalmente smontabile senza attrezzi per una profonda e accurata pulizia.

### GF Hp 4

- Made from AISI 304 Stainless steel.
- Machine strong and easy to clean.
- High efficiency ventilated motors for continuous operation.
- Large see-through plexiglass receiving tray (s/ steel optional).
- Stainless steel drum.
- Bright finished aluminium grating mouth.

### GF Hp 4

- Macchina da laboratorio per grosse produzioni.
- Ampia bocca di carico in alluminio brillantato internamente.
- Rullo in acciaio inox.
- Potenti motori ventilati per uso continuo.
- Capiente e pratica vasca di raccolta prodotto.

#### Versione CE:

Comandi 24 Volt IP 54 freno motore, microinterruttore di sicurezza su leva e su vasca raccolta formaggio.

### GF Hp 4

- Heavy duty machine.
- Large bright finished aluminium grating mouth.
- Stainless steel drum.
- High efficiency ventilated motors for continuous operation.
- Large plexiglass receiving tray.

#### CE version:

IP 54 protection rate 24V controls, motor break, safety microswitches on lever and receiving tray.



GFX HP 2

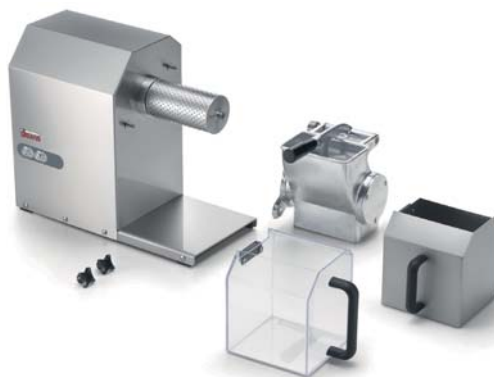
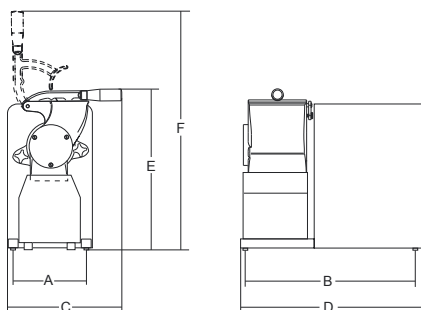

GFX HP 1.5-2

Vaschetta inox opzionale  
Optional s/steel tray

					A	B	C	D	E	F			
	watt/HP	r.p.m.	mm	mm	mm	mm	mm	mm	mm	mm	kg	mm	kg
<b>GFX Hp 1,5</b>	1.100/1,5	1ph/3ph	1.400	140x80	202	395	310	448	412	610	25	600x500x420	28
<b>GFX Hp 2</b>	1.500/2	1ph/3ph	1.400	190x95	228	475	330	528	518	730	35	800x600x520	38
<b>GF Hp 4</b>	3.000/4	3ph	1.400	300x160	340	700	640	750	640	1100	63	870x840x740	80



GFX HP 1,5



GF Hp 4





TCG-12E-22E

# TCG-12E-22E

tritacarne - grattugia  
meat grinder grater



- Combinato tradizionale per ristoranti e pizzerie.
- Costruzione in alluminio pressofuso lucidato.
- Motore ventilato.
- Rullo grattugia in acciaio trattato per uso alimentare.
- Riduttore tritacarne a bagno d'olio.
- Bocca ed elica tritacarne in ghisa trattata per uso alimentare, su richiesta anche in acciaio inox Aisi 304.
- Piastra e coltello inox.
- Inversione di marcia opzionale.

#### Versione CE:

- Microinterruttore di sicurezza su leva grattugia.
- Comandi IP54 con NVR.

#### Opzioni:

- Rullo inox per grattugia.
- Comandi con inversione.

- Traditional combined for restaurants and pizzerias.
- Polished die-cast aluminum construction.
- Ventilated motor.
- grating roller of steel treated for food use.
- oil bath gearbox meat grinder.
- Mouth and propeller mincer in untreated cast iron for food, on request in stainless steel AISI 304.
- S7steel plate and knife.
- optional reversing.

#### CE version:

- Microwitch on the grater.
- IP54 protection rated controls and NVR device.

#### Optionals:

- S/S drum.
- Reverse.



Griglia di protezione/Rullo inox di serie  
Protection grate/Standard stainless steel drum



Opzionale: Pulsantiera con inversione di marcia  
Optional: Push-button panel with reverse



Microinterruttore su grattugia  
Microwitch on the grater

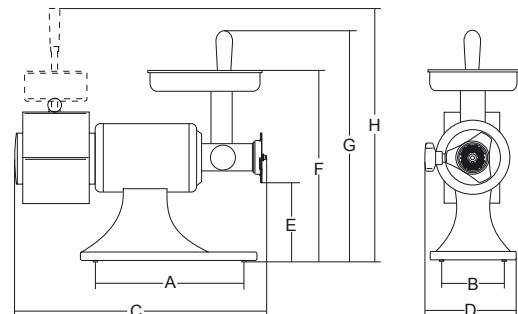

					A	B	C	D	E	F	G	H			
	watt/HP		Kg/10 min.	ø mm	mm	mm	mm	mm	mm	mm	mm	mm	kg	mm	kg
TCG 12 E	735/1	1ph/3ph	25	4.5	265	190	600	300	155	455	530	570	23	340x620x420	25
TCG 22 E	800/1.2	1ph/3ph	33	4.5	265	190	620	300	145	455	530	570	25	340x620x420	27



# TCG 8 VEGAS - TCG 12 DENVER



## tritacarne meat grinders



- Robusta struttura in alluminio anodizzato.
- Motore ventilato.
- Riduttore tritacarne ermetico con ingranaggi a bagno d'olio.
- Ingranaggi elicoidali temperati e rettificati.
- Bocca ed elica tritacarne in lega di alluminio alimentare brillantata.
- TCG 12 Denver: bocca ed elica tritacarne inox opzionali.
- Piastra e coltello inox.
- Bocca grattugia smontabile in lega di alluminio lucidata e anodizzata.
- Rullo grattugia inox.
- Pratico cassetto per piastra e coltello.
- Inversione di marcia serie.

### Versione CE con:

- Microinterruttori di sicurezza su vaschetta raccolta formaggio e leva.
- Comandi IP54 con NVR.

- *Sturdy anodized aluminum frame.*
- *Ventilated motor.*
- *Hermetic meat grinder gearbox with oil bath gears.*
- *hardened and ground helical gears.*
- *Mouth and meat grinder alloy blade of alums*
- *TCG 12 Denver: mouth and propeller Optional stainless meat grinder.*
- *S7steel plate and knife.*
- *Mouth removable grater aluminum alloy polished and anodised aluminum.*
- *Steel grating roller.*
- *Compartment for knife and plate.*
- *Standard reversing.*

### CE version with:

- *Safety microswitches on lever and receiving tray.*
- *IP54 protection rated controls and NVR device.*



TCG 8 VEGAS



TCG 12 DENVER



### TCG 12 DENVER

Passapomodoro opzionale  
Optional tomato sauce making

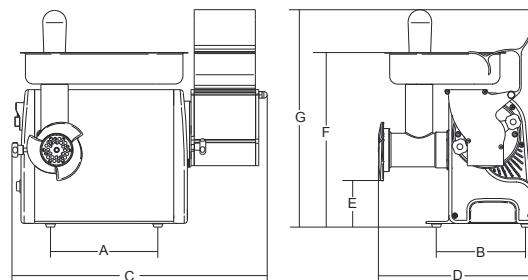

	watt/HP	1ph	Kg/h.	ø mm	mm	mm	mm	mm	mm	mm	mm	kg	mm	kg
TCG 8 Vegas	250/0.34	1ph	70	6	205	170	486	300	85	360	420	14	600x400x350	16
TCG 12 Denver	550/0.75	1ph	85	6	275	190	520	366	100	374	452	21.5	590x410x390	25



Cassetto porta coltello e piastra  
Compartment for knife and blade



# TCG 12-22 DAKOTA



TCG 12 DAKOTA

## tritacarne - grattugia meat grinder grater

- Corpo in alluminio anodizzato e fianchi in ABS antiurto.
- Generoso motore ventilato.
- Sistema di riduzione ad ingranaggi a bagno d'olio.
- Ingranaggi elicoidali temperati e rettificati.
- Bocca tritacarne e bocca grattugia facilmente rimovibili senza attrezzi.
- Bocca tritacarne in acciaio inox AISI 304 (o alluminio su mod. 22).
- Piastra e coltello inox.
- Bocca grattugia in alluminio brillantato di grande capienza.
- Capiente e pratica vasca di raccolta prodotto in plexiglass trasparente.
- Rullo smontabile in acciaio inox.
- Comandi con inversione di marcia di serie.

### Versione CE con:

- Comandi 24 volt con NVR.
- Dispositivo di sicurezza su vaschetta raccolta formaggio.
- Dispositivo di sicurezza sul pressore grattugia.

- Anodized aluminum body and ABS shockproof sides.
- Generous ventilated motor.
- reduction system in an oil bath gears.
- hardened and ground helical gears.
- mincer mouth and mouth easily removable without tools grating.
- Mouth stainless steel AISI 304 meat grinder (or aluminum on mod. 22).
- S7steel plate and knife.
- Mouth Aluminum grater large capacity polished.
- Capacious and practical bath product collection in transparent plexiglass.
- Stainless steel separable roller.
- Controls with standard reverse gear.

### CE version with:

- 24 volt controls and NVR device.
- Safety microswitch on the receiving tray.
- Safety microswitch on the lever.

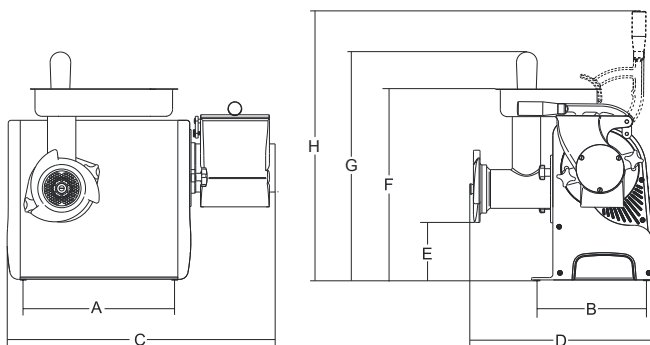

					A	B	C	D	E	F	G	H			
	watt/HP		Kg/10 min.	ø mm	mm	mm	mm	mm	mm	mm	mm	mm	kg	mm	kg
<b>TCG 12 Dakota</b>	1ph 750/1 3ph 1.100/1.5	1ph/3ph	95	4.5	310	225	560	360	130	415	495	575	29	630x430x450	33
<b>TCG 22 Dakota</b>	1ph 750/1 3ph 1.100/1.5	1ph/3ph	120	4.5	310	225	560	360	115	415	495	575	31	630x430x450	35



TCG 12 DAKOTA





# TC 12E-22E

## tritacarne meat grinders

- Costruzione in alluminio pressofuso lucidato.
- Motore ventilato.
- Riduttore tritacarne a bagno d'olio.
- Bocca ed elica tritacarne in ghisa trattata per uso alimentare, su richiesta anche in acciaio inox Aisi 304.
- Piastra e coltello inox.

### Versione CE con:

- Comandi IP54 con NVR.

### Opzioni:

- Comandi con inversione.

- Polished die-cast aluminum construction.
- Ventilated motor.
- oil bath gearbox meat grinder.
- Mouth and propeller mincer in untreated cast iron for food, on request in Aisi 304 stainless steel.
- S7steel plate and knife.

### CE version with:

- IP54 protection rated controls and NVR device.

### Optionals:

- Reverse.









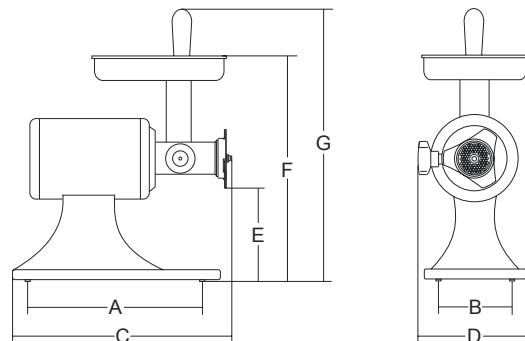







Passapomodoro per TC/TCG 12E  
Tomato press for TC / TCG 12E



Passapomodoro per TC/TCG 22E  
Tomato press for TC / TCG 22E



														
	watt/Hp		Kg/10 min.	ø mm	mm	mm	mm	mm	mm	mm	mm	kg	mm	kg
TC 12 E	735/1	1ph/3ph	25	4.5	225	185	430	215	140	445	520	18	320x460x470	20
TC 22 E	800/1.2	1ph/3ph	33	4.5	225	185	440	215	135	445	520	21	320x460x470	23



# TC 8 VEGAS - TC 12 DENVER



## tritacarne meat grinders

- Robusta struttura in alluminio anodizzato.
- Motore ventilato.
- Riduttore tritacarne ermetico con ingranaggi a bagno d'olio.
- Ingranaggi elicoidali temperati e rettificati.
- Bocca ed elica tritacarne in lega di alluminio alimentare brillantata.
- TC 12 Denver: bocca ed elica tritacarne inox opzionali.
- Piastra e coltello inox.
- Pratico cassettino per piastra e coltello.
- Inversione di marcia di serie.

### Versione CE con:

- Comandi IP54 con NVR.

- *Sturdy anodized aluminum frame.*
- *Ventilated motor.*
- *Hermetic meat grinder gearbox with oil bath gears.*
- *hardened and ground helical gears.*
- *Mouth and meat grinder alloy blade of alums*
- *TC 12 Denver: mouth and propeller Optional stainless steel meat grinder.*
- *S7steel plate and knife.*
- *Compartment for knife and plate.*
- *Reverse shuttle fitted as standard.*

### CE version with:

- *IP54 protection rated controls and NVR device.*



TC 8 VEGAS

TC 12 DENVER



### TCG 12 DENVER

Passapomodoro opzionale  
Optional tomato sauce making

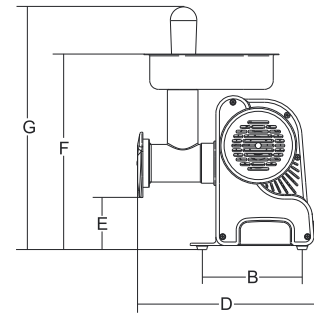
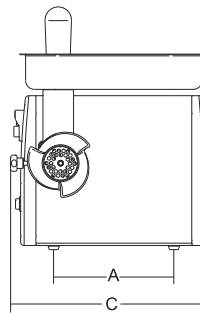

					A	B	C	D	E	F	G			
	watt/HP	1ph	Kg/h.	ø mm	mm	mm	mm	mm	mm	mm	mm	kg	mm	kg
TC 8 Vegas	250/0.34	1ph	70	6	205	170	335	300	85	360	410	10	560x400x350	12
TC 12 Denver	550/0.75	1ph/3ph	85	6	275	190	377	366	100	375	452	19	590x410x390	22.5



Cassetto porta coltello e piastra  
Compartment for knife and blade





# TC 12-22 DAKOTA

tritacarne  
meat grinders



TC 22 DAKOTA

- Facilmente trasportabile grazie alle pratiche maniglie.
- Corpo in alluminio anodizzato e fianchi in ABS antiurto.
- Generoso motore ventilato.
- Sistema di riduzione ad ingranaggi a bagno d'olio.
- Ingranaggi elicoidali temperati e rettificati.
- Bocca tritacarne in acciaio inox AISI 304 (o alluminio su mod. 22).
- Piastra e coltello inox.
- Comandi con inversione di marcia di serie.

**Versione CE con:**

- Comandi 24 volt con NVR.
- Easily transportable thanks to practical handles.
- Anodized aluminum body and ABS shockproof sides.
- Generous ventilated motor.
- reduction system in an oil bath gears.
- hardened and ground helical gears.
- Mouth stainless steel AISI 304 meat grinder (or aluminum on mod. 22).
- S7 steel plate and knife.
- Controls with standard reverse gear.

**CE version with:**

- 24 volt controls and NVR device.

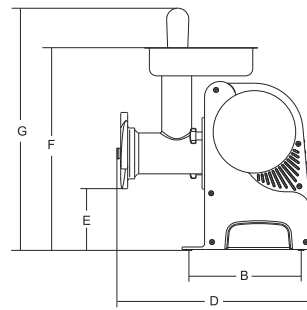
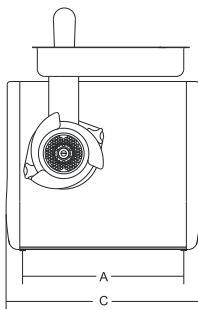

	watt/HP		Kg/h.	ø mm	mm	mm	mm	mm	mm	mm	mm	kg	mm	kg
<b>TC 12 Dakota</b>	1ph 750/1 3ph 1.100/1.5	1ph/3ph	95	4.5	310	225	395	360	130	415	485	24	570x750x800	34
<b>TC 22 Dakota</b>	1ph 750/1 3ph 1.100/1.5	1ph/3ph	120	4.5	310	225	395	360	115	415	485	26	570x750x800	36



TC 12 DAKOTA

Passapomodoro per TC12 opzionale  
Optional tomato sauce making for TC12



TC 12 DAKOTA



# DOLOMITI

## abbattitori blast chillers

- Studiati per grandi prestazioni e facile utilizzo.
- Dolomiti 3 P e Dolomiti 5 P: struttura esterna in lamiera plastificata ed interna in acciaio inox
- Dolomiti 5-7-10-14 Gelateria: struttura esterna ed interna in acciaio inox.
- Capaci di contenere sia gastronorm 1/1 che teglie pasticceria 60x40 cm (no Dolomiti 3 2/3).
- Distanza tra ripiani regolabile.
- Abbattimento positivo, negativo, hard e mantenimento.
- Sistema di ventilazione diffuso che evita di rovinare il prodotto.
- Gas R404A.
- Guarnizione porta riscaldata per evitarne il bloccaggio.
- Portata max garantita di Kg 150 per tutte le versioni da pavimento con top.
- Disponibili senza top per il posizionamento sotto banchi/tavoli da lavoro.
- Porte reversibili di serie per tutti i modelli da pavimento.

- *Designed for high efficiency and ease of use.*
- *Dolomiti Dolomiti 3 P and 5 P: external structure in plastic and inner stainless steel plate*
- *Dolomiti 5-10-14 Gelateria: made from stainless steel.*
- *It can accept both 1/1 gastronorm that baking tins 60x40 cm (no Dolomiti 3 2/3).*
- *Distance between adjustable shelves.*
- *Blast freezing, chilling, hard and maintenance.*
- *ventilation system that prevents spread of ruining the product.*
- *Gas R404A.*
- *Heated door gasket avoids locking.*
- *Max capacity guaranteed 150 kg for all floor standing versions with top.*
- *Available without top for placement under desks / work tables.*
- *Standard reversible doors for all floor models.*



DOLOMITI 3 P 1/1

DOLOMITI 3 P 2/3



DOLOMITI 5



DOLOMITI 5 P



DOLOMITI 5 1/1



DOLOMITI 5 P 1/1



Comandi standard  
Standard controls



Comandi Gelateria  
Gelateria controls



Sonda rilevamento temperatura  
Probe to survey the core temperature of the product



Distanza ripiani mm 50 regolabile  
Distance between shelves adjustable mm 50

**Comandi Standard:**  
abbattimento positivo/negativo/hard e mantenimento.  
facile ed intuitivo sia a tempo che a sonda  
ciclo di sbrinamento.  
**Comandi Gelateria:**  
abbattimento positivo/negativo/hard e mantenimento.  
ciclo di sbrinamento.  
con programmi.  
predisposizione per la sonda riscaldata (opzionale).

**Standard controls:**  
Blast freezing/chilling, hard and hold program.  
Time and probe easy and intuitive use.  
Defrosting program.  
**Gelateria controls:**  
Blast freezing/chilling, hard and hold program.  
Defrosting program.  
Programmable.  
Equipped with optional heated probe.



Porte reversibili di serie per Dolomiti 5, 10 e 14  
reversible doors for Dolomiti number 5, 10 and 14

DOLOMITI 5  
Disponibili senza top per il posizionamento sotto il banco/tavolo da lavoro  
DOLOMITI 5  
Available without top for under counter installation

DOLOMITI GELATERIA



DOLOMITI 5 GELATERIA



DOLOMITI 7 GELATERIA



DOLOMITI 10 GELATERIA



DOLOMITI 14 GELATERIA



**DOLOMITI 3 P 2/3**

n.3 -> 2/3 GN



**DOLOMITI 3 P 1/1**

n.3 -> 1/1 GN



**DOLOMITI 5 1/1**

n.5 -> 1/1 GN



**DOLOMITI 5**

n.5 -> 1/1 GN  
n.5 -> cm 60x40



**DOLOMITI 5 GELATERIA**

n.5 -> 1/1 GN  
n.5 -> cm 60x40



**DOLOMITI 7 GELATERIA**

n.7 -> 1/1 GN  
n.7 -> cm 60x40



**DOLOMITI 10 GELATERIA**

n.10 -> 1/1 GN  
n.10 -> cm 60x40



**DOLOMITI 14 GELATERIA**

n.14 -> 1/1 GN  
n.14 -> cm 60x40

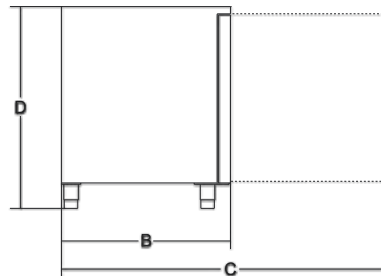
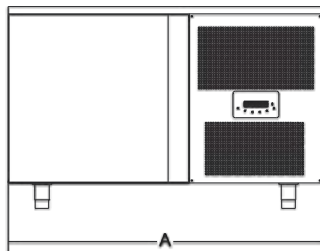

	watt		°C		lt	n.	lt	mm	mm	mm	mm	kg	mm	kg
			+70/+3°C	+70/-20°C				A	B	C	D			
<b>Dolomiti 3 P 2/3</b>	1ph	680	90 min./kg 8	240 min./kg 5	29	3 - 2/3 GN	340x340 h.270	640	630	1020	400	45	660x650x550	50
<b>Dolomiti 3 P 1/1</b>	1ph	758	90 min./kg 9	240 min./kg 6	36	3 - 1/1 GN	340x550 h.370	640	740	1220	500	60	660x760x650	68
<b>Dolomiti 5 1/1</b>	1ph	1.116	90 min./kg 10	240 min./kg 7	70	5 - 1/1 GN	560x470 h.330	680	680	1295	880	85	700x750x1050	95
<b>Dolomiti 5 P 1/1</b>	1ph	1.116	90 min./kg 10	240 min./kg 7	70	5 - 1/1 GN	560x470 h.330	680	680	1295	880	85	700x750x1050	95
<b>Dolomiti 5</b>	1ph	1.200	90 min./kg 12	240 min./kg 9	95	5 - 1/1 GN 5 - cm 60x40	630x540 h.330	750	750	1435	880	95	770x820x1050	105
<b>Dolomiti 5 P</b>	1ph	1.200	90 min./kg 12	240 min./kg 9	95	5 - 1/1 GN 5 - cm 60x40	630x540 h.330	750	750	1435	880	95	770x820x1050	105
<b>Dolomiti 5 Gelateria</b>	1ph	1.385	90 min./kg 12	240 min./kg 9	95	5 - 1/1 GN 5 - cm 60x40	630x540 h.330	750	750	1435	850	98	770x820x1020	108
<b>Dolomiti 7 Gelateria</b>	1ph	1.493	90 min./kg 20	240 min./kg 12	150	7 - 1/1 GN 7 - cm 60x40	630x420 h.600	1300	700	1435	830	155	1320x720x1000	165
<b>Dolomiti 10 Gelateria</b>	3ph	1.775	90 min./kg 25	240 min./kg 15	206	10 - 1/1 GN 10 - cm 60x40	630x430 h.760	750	750	1435	1500	185	770x820x1670	200
<b>Dolomiti 14 Gelateria</b>	3ph	3.400	90 min./kg 40	240 min./kg 25	282	14 - 1/1 GN 14 - cm 60x40	630x430 h.1040	750	750	1435	1900	265	770x820x2070	280

# CANEVA

## stagionatore di salumi *charcuterie seasoner*



- Controllo elettronico di umidità, temperatura e tempi di stagionatura a vari livelli.
- Pratico controllo touch facilmente accessibile e riposizionabile.
- 10 programmi facilmente richiamabili da tastiera.
- Controllabile tramite pratica APP che permette:
  - di gestire infiniti programmi a più livelli
  - di archiviare i dati di controllo ai fini dell'HACCP
  - di recuperare programmi collaudati
  - una gestione facile e intuitiva.
- *Electronic control over humidity, temperature and seasoning times on no. Levels.*
- *Practical touch control, that is easy to access and easy to position.*
- *10 programmes that are easily retrievable via the keyboard.*
- *Can be controlled via the handy APP that allows you:*
  - \* *to manage an infinite number of programmes on various levels*
  - \* *to store the control data for HACCP purposes*
  - \* *to retrieve tested programmes*
  - \* *easy and intuitive management.*



## LAVORAZIONE CARNE

Per venire incontro alle esigenze di un ampio ed importante settore del mercato - quale quello rivolto alla lavorazione della carne a tutti i livelli - Sirman propone un'ampia e diversificata scelta di strumenti per gli addetti ai lavori quali tritacarne, segaossa, insaccatrici, impastatrici e altre utili attrezzature.

Affidabilità, performance e resistenza agli ambienti più impegnativi, sono diventate le linee guida per lo sviluppo di sempre nuovi prodotti e soluzioni in questo settore. L'attenzione alla facile pulizia e sanificazione, grazie alla smontabilità dei particolari più critici, e la facile manutenibilità, sono oramai diventati caratteri distintivi di questa linea di prodotti, riconosciuti dal mercato italiano e internazionale.

## MEAT PROCESSORS

*To fulfill the needs of an important as well as complex business such as the meat processing industry at all levels, Sirman offers a wide and diversified array of products such as mincers, mixer-grinders, saws, fillers and mixer kneaders. Dependability, performance and durability into the harshest environments are the guidelines for the development of new products and solutions. Furthermore, the ease of maintenance, cleaning and sanitation due to the fast breakdown of the critical parts are distinguishing features of Sirman meat processing machines, nationally and internationally recognized.*



## tritacarne meat grinders

AMBIENTE DI UTILIZZO											°C
TC VEGAS	■	■									+
TC DENVER	■	■									+
TC DAKOTA		■	■								+
TC COLORADO		■	■	■	■	■	■	■			- 3
TC BARCELONA			■	■	■	■	■	■			- 3
TC NEVADA			■	■	■	■	■	■			- 3
TC CALIFORNIA				■	■	■	■	■	■		- 3
TC BUFFALO				■	■	■	■	■	■		- 5
TC MONTANA							■	■	■	■	- 7
MASTER							■	■	■	■	- 7
kg/h.	30	50	150	200	300	350	500	700	1000	1300	

## impastatrici per carne meat mixers

USO	<b>H</b>	<b>H</b>	<b>M</b>	<b>L</b>	<b>D</b>	<b>S</b>
IP 10/20 M	■	■	■	■	■	■
IP 30/50 M Y14	■	■	■	■	■	■
IP 50-80 XP BA	■	■	■	■	■	■
IP 120-180 XP BA	■	■	■	■	■	■

- Ideale per l'uso  
*Ideal for the use*
- Utilizzabile con pala specifica  
*Usable with recommended shaft*
- Utilizzabile  
*Usable for this product*
- Sconsigliata  
*Not recommended for this use*







# TC 22-32 COLORADO

tritacarne  
meat grinders



- Corpo macchina totalmente in acciaio inox AISI 304.
- Potenti motori IP 55 autoventilati per uso continuo.
- Riduttore a bagno d'olio con ingranaggi rettificati.
- Riduttore con doppio sistema di protezione dai liquidi.
- Rapido fissaggio bocca senza utensili.
- Gruppo macinazione completamente in acciaio inox facilmente e totalmente smontabile per pulizia.
- Tramoggia rimovibile interbloccata (32 CE).
- Comandi 24 Volt IP 54 con inversione (CE).

**Opzioni:**

- Bocche Unger parziale o totale.
- Comandi inox IP 67.

- *AISI 304 stainless steel construction.*
- *Powerful IP 55 insulated and fan-cooled motors for continuous use.*
- *Endless screw motor-reducer running in an oil-bath enables a long service life .*
- *Motor-reducer equipped with a double seal for long, trouble-free service.*
- *Head can be locked in with no tools.*
- *Stainless steel head with high output capacity, completely removable for cleaning.*
- *Feed tray provided with safety interlock (no. 32 CE versions).*
- *IP 54 protected, 24 V controls.*

**Optionals:**

- *Partial or total Unger system mincing head.*
- *Stainless steel IP 67 protected controls.*



TC 32 COLORADO



P. 121

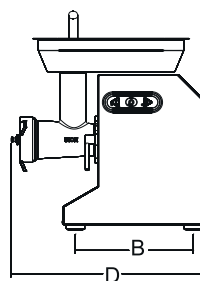
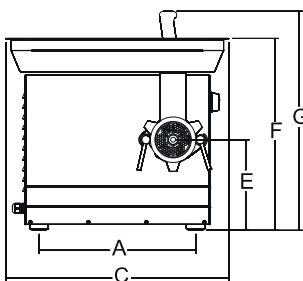

					A	B	C	D	E	F	G			
	watt/HP	1ph/3ph	kg/h.	ø mm	mm	mm	mm	mm	mm	mm	mm	kg	mm	kg
<b>TC 22 Colorado</b>	1.470/2	1ph/3ph	300	4,5	350	264	500	437	205	432	490	32	600x500x500	35
<b>TC 32 Colorado</b>	2.205/3	1ph/3ph	400	6	400	264	610	465	190	427	530	39	720x570x770	61



TC 22 COLORADO



Format M opzionale  
Optional Format M

TC 22 COLORADO con hamburgertrice



# TC 32 CALIFORNIA



## tritacarne meat grinders

- Tritacarne solido, robusto e performante adatto a piccoli laboratori, collettività, mense e grandi cucine.
- Dotato di gambe e ruote in acciaio inox con freno per una sicura stabilità e grande praticità.
- Corpo macchina totalmente in acciaio inox AISI 304.
- Grande tramoggia di carico 410x610x76 mm con micro per una maggior sicurezza.
- Potenti motori IP 55 autoventilati per uso continuo.
- Riduttore a bagno d'olio con ingranaggi rettificati.
- Riduttore con doppio sistema di protezione dai liquidi.
- Rapido fissaggio bocca senza utensili.
- Gruppo macinazione completamente in acciaio inox facilmente e totalmente smontabile per pulizia.
- Tramoggia rimovibile interbloccata (CE).
- Comandi inox, 24 Volt IP67.

### Opzioni:

- Bocche Unger parziale o totale.

- *Heavy-duty meat grinder with high capacity, suitable for all kitchens.*
- *The machine is on stand with stainless steel casters and therefore very stable and easy to move.*
- *AISI 304 stainless steel construction.*
- *Large mm 410x610x76 feeding tray with safety microswitch.*
- *Powerful IP 55 insulated and fan-cooled motors for continuous use.*
- *Endless screw motor-reducer running in an oil-bath enables a long service life.*
- *Motor-reducer equipped with a double seal for long, trouble-free service.*
- *Head can be locked in with no tools.*
- *Stainless steel head with high output capacity, completely removable for cleaning.*
- *Feed tray provided with safety interlock CE versions.*
- *Stainless steel IP 67 protected, 24 V controls.*

### Optionals:

- *Partial or total Unger system mincing head.*



Standard o enterprise    1/2 Unger    Unger Totale

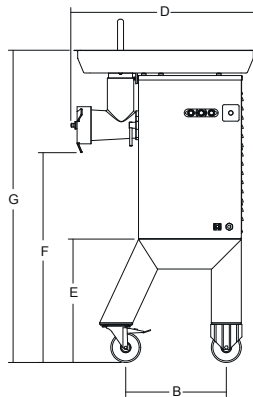
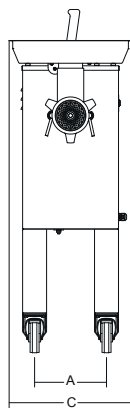

	watt/Hp	1ph/3ph	kg/h.	ø mm	mm	mm	mm	mm	mm	mm	mm	kg	mm	kg
<b>TC 32 California</b>	2.205/3	1ph/3ph	400	6	240	336	410	621	412	700	1042	55	720x570x1180	70





# TC 22-32 BARCELONA

## tritacarne meat grinders

- Tritacarne compatto dalle alte prestazioni.
- Comandi IP 54 in 24 Volt con inversione (versione CE).
- Riduttore ermetico a bagno d'olio.
- Riduttore protetto dai liquidi da un doppio sistema di isolamento.
- Bocca e perno trascinatore in acciaio inox Aisi 304.
- Rapido e robusto sistema di fissaggio bocca, blocco rapido bocca brevettato su TC 32.
- Versione 22 disponibile anche con collo tondo.
- Potenti motori ventilati, per uso continuo.
- Motori monofase con protezione termica.
- Pratico vano porta piastre e coltelli con coperchio.
- Estrema semplicità di pulizia.

### Opzioni:

- Bocca unger e semiunger Hamburgatrice. Insaccatrice continua. Tramoggia gigante. Gambe medie per TC 32. Sistema di protezione interbloccato per uso piastre con foro > 8 mm.

- *Heavy duty compact mincer.*
- *IP 54 protection rate, 24 Volt controls, reverse (CE version).*
- *Sealed oil-bath gear box.*
- *Waterproof gear box with double sealing system.*
- *Aisi 304 S/S mouth and feeding worm.*
- *Quick and sturdy head locking system (patented on 32 version).*
- *22 version available also with round feeding neck.*
- *High efficiency ventilated motors for continuous operation.*
- *Thermal protection on single phase motors.*
- *Compartment for knives and plates.*
- *Easy cleaning.*

### Optionals:

- *Total/half unger system. Patty former. Stuffer kit. Oversize tray. Medium legs for TC 32. Interlock protection for more than 8 mm holes plates (An interlock protection system is required in order to utilize more than 8 mm holes plates).*



TC 32 BARCELONA



P. 121



TC 22 BARCELONA



TC 22 BARCELONA □



TC 22 BARCELONA ○



# TC-22-32-BARCELONA-ICE

tritacarne refrigerato  
*refrigerated meat grinder*



TC 22 BARCELONA ICE

TC 32 BARCELONA ICE



Standard o  
enterprise    1/2  
Unger    Unger Totale



P. 121

- Innovativo e supercompatto tritacarne refrigerato.
- Sistema raffreddante con modulo termoelettrico: senza compressore, senza gas, a risparmio energetico.
- Potenza modulo termoelettrico: 70 Watt
- Raffreddamento su collo e bocca.
- Termometro digitale di controllo.
- Tramoggia e collo inox rimovibili per la pulizia.
- Caratteristiche TC come modello Barcellona.
- Qualsiasi manutenzione non necessita di frigorista.
- Collo di introduzione quadro per grande produttività anche in seconda passata.
- Motori monofase con protezione termica.
- Blocco rapido bocca brevettato su 32.

**Opzioni:**

- Bocca unger e semiunger. Hamburgatrice. Insacchitrice continua. Tramoggia gigante. Sistema di protezione interbloccato per uso piastre con foro > 8 mm.

- *Innovative extremely compact refrigerated mincer.*
- *Thermo-electric module refrigeration system: without compressor, without gas, energy saving.*
- *Thermo-electric module power: 70 Watt*
- *Refrigerated feeding neck and grinding end.*
- *Self-adjusted temperature.*
- *Removable and easy to clean S/S tray and feeding neck.*
- *Same mincing features as model Barcellona.*
- *Easy maintenance (no need of refrigerator technician).*
- *Square feeding neck (high output also with pre-minced meat).*
- *Thermal protection on single phase motors.*
- *Quick and sturdy head locking system (patented on 32 version).*

**Optionals:**

- *Half/total unger system. Patty former. Stuffer kit. Oversize tray. Medium legs for TC 32. Interlock protection for more than 8 mm holes plates (An interlock protection system is required in order to utilize more than 8 mm holes plates).*



Opzione gambe con ruote e tramoggia gigante  
*Optional legs with wheels and oversize tray*



TC 32 BARCELONA Q ICE con hamburgatrice



Vano per piastre e coltelli  
Compartment for knives and plates



Sblocco bocca TC 32/ICE  
Head locking TC 32 / ICE



Opzione insaccatrice  
Optional stuffer kit



Griglie di ventilazione TC ICE  
TC ICE airing take



Comandi TC ICE  
TC ICE controls



Opzione hamburger  
Optional hamburger press

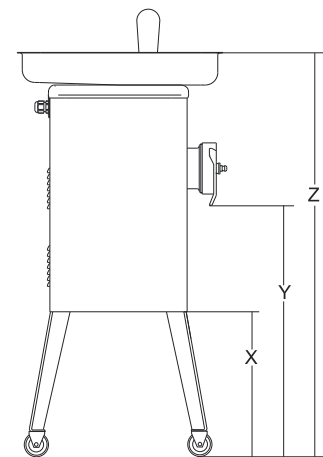
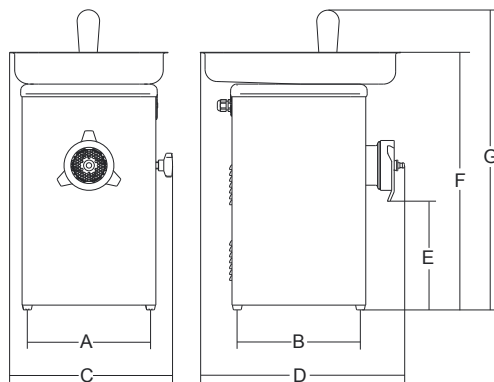

Gambe medie con ruote per TC 32 opzionali  
Optional medium legs with wheels for TC 32  
X: 435 mm  
Y: 685 mm  
Z: 1005 mm

					A	B	C	D	E	F	G				
	watt/HP		kg/h.	ø mm	mm	mm	mm	mm	mm	mm	mm	kg	mm	kg	
TC 22 Barcellona	○	1ph 1.100/1,5 3ph 1.472/2	1ph/3ph	300	4.5	250	185	310	467	225	540	615	31	720x570x770	41
TC 22 Barcellona	□	1ph 1.100/1,5 3ph 1.472/2	1ph/3ph	350	4.5	250	185	310	467	225	540	615	31	720x570x770	41
TC 32 Barcellona	□	1ph 1.840/2,5 3ph 2.200/3	1ph/3ph	500	4.5	250	320	355	557	260	580	690	44	720x570x770	54
TC 22 Barcellona ice	□	1ph 1.100/1,5 3ph 1.472/2	1ph/3ph	350	4.5	250	185	310	467	225	540	615	34	720x570x770	44
TC 32 Barcellona ice	□	1ph 1.840/2,5 3ph 2.200/3	1ph/3ph	500	4.5	250	320	355	557	260	580	690	48	720x570x770	58

# TC 22-32 NEVADA



TC 22 NEVADA

## tritacarne meat grinders

- Corpo macchina totalmente in acciaio inox AISI 304.
- Potenti motori IP 55 autoventilati per uso continuo.
- Riduttore a bagno d'olio con ingranaggi rettificati.
- Riduttore con doppio sistema di protezione dai liquidi.
- Pratico fissaggio bocca con leva interbloccata (CE).
- Gruppo macinazione ad alta produzione completamente in acciaio inox.
- Collo introduzione quadro per prestazioni superbe in seconda passata.
- Tramoggia rimovibile interbloccata (CE) con collo fino a zona macinazione.
- Comandi inox IP 67 con inversione (CE).

### Opzioni:

- Sistema di protezione interbloccato per uso piastre con foro > 8 mm.
- Bocche Unger parziale o totale.
- Coperchio plexiglass su tramoggia.
- Hamburgatrice Format M.

- *AISI 304 stainless steel construction.*
- *Powerful IP 55 insulated and fan-cooled motors for continuous use.*
- *Endless screw motor-reducer running in an oil-bath enables a long service life.*
- *Motor-reducer equipped with a double seal for long, trouble-free service.*
- *Convenient head interlock mechanism (CE versions).*
- *Stainless steel mincing head carefully designed for high yield production.*
- *Feed tray designed with square neck for outstanding performance.*
- *Feed tray provided with safety interlock (CE versions).*
- *Stainless steel IP 67 protected controls.*

### Options:

- *Interlock protection for more than 8 mm holes plates (An interlock protection system is required in order to utilize more than 8 mm holes plates).*
- *Partial or total Unger system mincing head.*
- *Plexiglass feed tray lid.*
- *Hamburger press attachment FORMAT M.*



Coperchio opzionale  
Optional lid



P. 121



Standard o  
enterprise    1/2  
Unger    Unger  
Totale

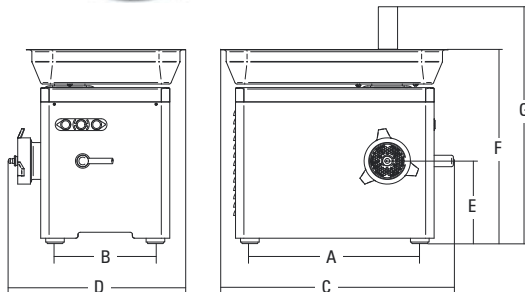

	watt/Hp	kg/h.	ø mm	mm	mm	mm	mm	mm	mm	mm	mm	kg	mm	kg
<b>TC 22 Nevada</b>	1ph 1.100/1,5 3ph 1.472/2	1ph/3ph	350	4.5	374	221	512	437	182	428	531	36	600x500x500	39
<b>TC 32 Nevada</b>	1ph 1.840/2,5 3ph 2.200/3	1ph/3ph	500	4.5	480	285	637	496	207	447	551	50	720x570x770	72



# TC 22-32 NEVADA ICE

tritacarne refrigerato  
refrigerated meat grinder



- Caratteristiche tecniche e performance identiche a Nevada.
- Impianto refrigerante 150 Watt con gas R304.
- Refrigerazione su collo, bocca e tramoggia.
- Comandi inox IP 67 con inversione.

**Opzioni:**

- Sistema di protezione interbloccato per uso piastre con foro > 8 mm.
- Bocche Unger parziale o totale.
- Coperchio plexiglass su tramoggia.
- Hamburgatrice Format M.

- *Technical specifications and performance identical to Nevada.*
- *150 Watt, R304 gas refrigerator.*
- *Refrigeration on feed tray neck, mincing head and on the whole feed tray.*
- *IP 67 protection rated controls with reverse.*

**Optionals:**

- *Interlock protection for more than 8 mm holes plates (An interlock protection system is required in order to utilize more than 8 mm holes plates).*
- *Partial or total Unger system mincing head.*
- *Plexiglass feed tray lid.*
- *Hamburger press attachment FORMAT M.*



TC 22 NEVADA ICE

P. 121



Standard enterprise    1/2 Unger    Unger Totale

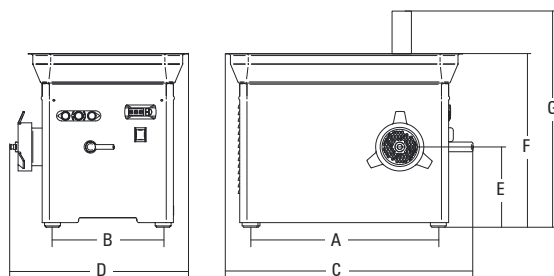

	watt/HP	kg/h.	ø mm	mm	mm	mm	mm	mm	mm	mm	mm	kg	mm	kg
<b>TC 22 Nevada Ice</b>	1ph 1.100/1.5 3ph 1.472/2	1ph/3ph	350	4.5	374	221	512	437	237	481	585	48	720x570x770	70
<b>TC 32 Nevada Ice</b>	1ph 1.840/2.5 3ph 2.200/3	1ph/3ph	500	4.5	480	285	637	496	207	447	551	60	720x570x770	82







# TC BUFFALO

tritacarne  
meat grinders



## TC 32 BUFFALO

Versione da tavolo  
Table top version

- Grandi prestazioni in una struttura compatta.
- Bocca ad alta produzione dal disegno esclusivo.
- La grande disponibilità di accessori la rende adatta sia per l'uso nel banco che nel laboratorio.
- Bocca inox esterna con rapido fissaggio a baionetta.
- Collo introduzione quadro per grande produttività anche in seconda passata.
- Sistema di protezione ingranaggi con doppio paraolio.
- Motore ventilato per uso continuo.
- Comandi inox IP 67 con inversione.

### Opzioni:

- Sistema di protezione contro i sovraccarichi di corrente.
- Tramoggia gigante e super (no TC 32 Buffalo S).
- Gambe alte medie e basse (no TC 32 Buffalo S).
- Piano portavassoio estraibile.
- Bocca unger e semiunger.
- Insacatrice continua.
- Paraspruzzi.
- Sistema di protezione interbloccato per uso piastre con foro > 8 mm.
- Predisposizione per Format S con pedaliera (no TC 32 Buffalo S).



## TC 32 BUFFALO

Opzionale: Tramoggia gigante e Gambe  
Optional legs and larger feed tray

- Compact heavy duty mincer.
- Exclusive design high output grinding head.
- Available both table top or floor standing (many optionals available).
- Stainless steel head with quick bayonette fitting.
- Square feeding neck (high output also with pre-minced meat).
- Gear box with double sealing system.
- Ventilated motor for continuous operation.
- IP 67 protection rated controls with reverse.

### Optionals:

- Overload protection.
- Larger trays: "gigante" or "super" (not available for TC 32 Buffalo S).
- Short, medium, long legs (not available for TC 32 Buffalo S).
- Receiving tray holder.
- Half/total unger system.
- Stuffer kit.
- Splash guard.
- Interlock protection for more than 8 mm holes plates (An interlock protection system is required in order to utilize more than 8 mm holes plates).
- Arrangement for Format S with pedal controls (not available for TC 32 Buffalo S).



P. 121

Pedaliera opzionale  
Optional pedal controls



TC 32 BUFFALO S

**Opzionali:**

**Options:**



Supporto vassoio  
Tray support



Tramoggia gigante  
Larger feed tray



Tramoggia super  
Larger tray super



Gambe con ruote  
Legs with wheels



Protezione bocca per piastra con foro  
Ø > 8 mm  
Safety device for Ø > 8 mm plates.



Paraspruzzi  
Splash guard



Estrattore piastre  
Plates removal tool



Standard o 1/2 Unger  
enterprise Unger Totale

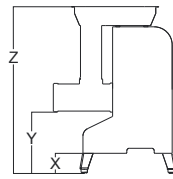
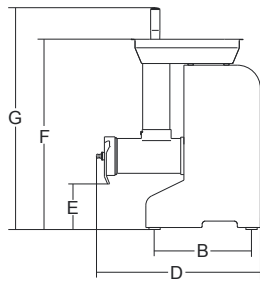
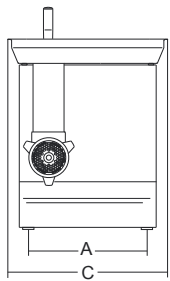

Gambe basse con piedino  
Short legs with feet

X: 131 mm  
Y: 271 mm  
Z: 741 mm

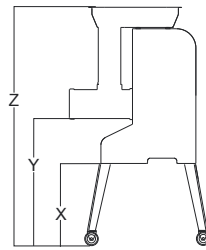

Gambe medie con ruote  
Medium legs with wheels

X: 416 mm  
Y: 556 mm  
Z: 1026 mm

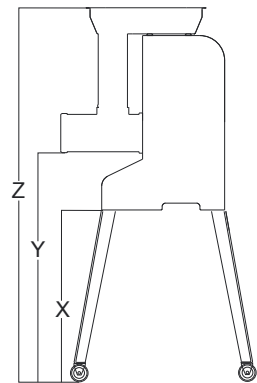

Gambe alte con ruote  
High legs with wheels

X: 688 mm  
Y: 828 mm  
Z: 1298 mm

					<b>A</b>	<b>B</b>	<b>C</b>	<b>D</b>	<b>E</b>	<b>F</b>	<b>G</b>			
	watt/HP	1ph/3ph	kg/h.	ø mm	mm	mm	mm	mm	mm	mm	mm	kg	mm	kg
<b>TC 32 Buffalo Hp 3</b>	2.205/3	1ph/3ph	700	4.5	385	315	535	505	140	610	710	65	640x760x850	80
<b>TC 32 Buffalo Hp 4</b>	2.940/4	3ph	700	4.5	385	315	535	505	140	610	710	65	640x760x850	80
<b>TC 32 Buffalo Hp 4 S</b>	2.940/4	3ph	700	4.5	446	320	625	538	123	592	691	70	640x760x850	85
<b>Tramoggia standard</b>	-	-	-	-	-	-	-	535x450x90	-	-	-	-	-	-
<b>Tramoggia gigante</b>	-	-	-	-	-	-	-	535x660x90	-	-	-	-	-	-
<b>Tramoggia super</b>	-	-	-	-	-	-	-	563x900x120	-	-	-	-	-	-



# TC MONTANA

## tritacarne meat grinders



- Costruzione in acciaio inox AISI 304 lavabile con spruzzo d'acqua.
- Riduttore ermetico a bagno d'olio.
- **Gruppo macinazione:**
- Completamente in acciaio inox AISI 304
- Studiato per grandi prestazioni
- Alte prestazioni anche in seconda e successive passate
- Produzione oraria effettiva 1.100 Kg/h (42)
- Produzione oraria teorica 3.500 Kg/h
- Rimanezza carne interno bocca 50-90 g
- Perno trascinatore in acciaio inox
- **Con esclusivo sistema brevettato di controllo presenza piastra e ghiera (CE)**
- Perno elicica in acciaio temperato
- Veloce smontaggio gruppo macinazione per pulizia e sanificazione
- Collo introduzione quadro per maggiore velocità di carico
- Ampia tramoggia 563 x 900 h. 120 mm con micro di sicurezza
- Comandi in acciaio inox IP 67 con inversione di marcia (versione CE)

- *AISI 304 stainless steel construction, can be sprayed.*
- *Sealed oil-bath gear box.*
- **Grinding set:**
- *Completely made of AISI 304 stainless steel*
- *Designed for high performance*
- *High performance even product is processed two or more times.*
- *Hourly output: 1.100 Kg (actual) (42)*
- *Hourly output: 3.500 kg (possible)*
- *Unprocessed meat inside grinding set at working cycle end: 50-90 g.*
- *Stainless steel drive pin.*
- **Exclusive, patented plate and ring nut detection system (CE)**
- *Tempered steel worm pin.*
- *Grinding set is quickly disassembled of faster cleaning and sanitation.*
- *Square feeding "neck" allows for faster processing cycles.*
- *Large feeding hopper 563x900 h. 120 mm with safety microswitch*
- *IP 67 water protected stainless steel controls with reverse (on CE versions).*



TC 42 MONTANA Y12



P. 121



TC 32 MONTANA Y12



TC 32 MONTANA Y12

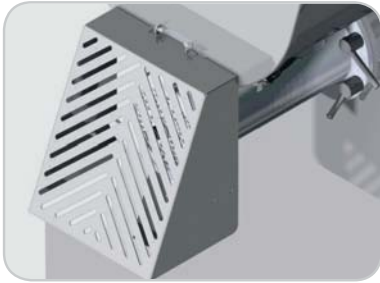

Opzionale: sistema di protezione interbloccato per uso piastre con foro > 8 mm.  
 Optional: interlock protection for more than 8 mm holes plates.



Opzionale: paraspruzzi  
 Optional: splash guard



Pedaliere opzionale  
 Optional pedal controls

**Optional disponibili:**

- Comandi FULL CONTROL per gestione accessori
- Tramoggia gigante lt. 78
- Paraspruzzi inox
- Comando a pedale
- Bocca unger parziale inox
- Bocca unger totale inox
- Bocca lunga
- Sistema di protezione interbloccato per uso piastre con foro > 8 mm.
- Ampia disponibilità di piastre e coltelli specifici
- FORMAT S
- FORMAT A

**Dotazione standard:**

- Coltello e piastra diam. 4,5 autoaffilanti inox
- Pestello
- Attrezzo estrazione elica e piastre
- Manuale uso e manutenzione

**Standard accessories:**

- Stainless steel self-sharpening knife and 4,5 mm plate
- Pestle
- Worm and plate removing tool
- Use and maintenance manual









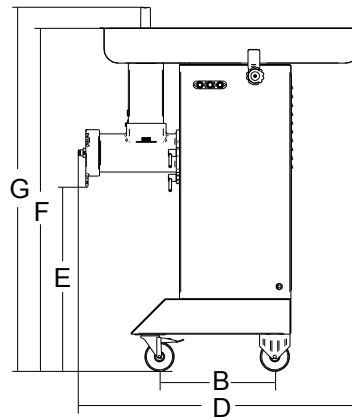
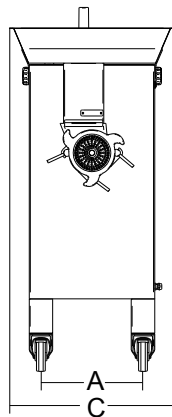







Estrattore piastre  
 Plates removal tool

**Optional available:**

- FULL CONTROLS for accessories handling
- Larger feed tray lt. 78
- Stainless steel splash guard
- Pedal control
- Stainless steel 1/2 unger grinding set
- Stainless steel total unger grinding set
- Longer head
- Interlock protection for more than 8 mm holes plates (An interlock protection system is required in order to utilize more than 8 mm holes plates).
- Wide selection of plates and knives
- FORMAT S
- FORMAT A



														
	watt/HP		kg/lt.	ø mm	mm	mm	mm	mm	mm	mm	mm	kg	mm	kg
<b>TC 32 Montana Y12</b>	2.940/4	1ph/3ph	700	4.5	348	393	564	911	654	1169	1237	90	1050x950x1960	115
<b>TC 32 Montana Y12 Bocca lunga</b>	-	-	-	-	348	393	564	1005	654	1169	1237	93	1050x950x1960	118
<b>TC 42 Montana Y12 Hp 5</b>	3.675/5	1ph/3ph	800-1000	4.5	348	393	564	973	631	1171	1241	112	1050x950x1960	137
<b>TC 42 Montana Y12 Hp 7</b>	5.145/7	1ph/3ph	1200-1300	4.5	348	393	564	973	631	1171	1241	112	1050x950x1960	137
<b>TC 42 Montana Y12 Bocca lunga</b>	-	-	-	-	348	393	564	1063	631	1171	1241	132	1050x950x1960	157
<b>TC 42 Montana Y12 Tramoggia gigante</b>	-	-	-	-	348	393	626	1125	631	1282	1282	128	1050x950x1960	153
<b>TC 42 Montana Tramoggia gigante + Bocca lunga</b>	-	-	-	-	348	393	626	1215	631	1282	1282	148	1050x950x1960	173



# MASTER

## tritacarne - impastatrice meat grinders - meat mixers



- Costruzione in acciaio inox AISI 304 lavabile con spruzzo d'acqua.
- 2 motori indipendenti IP x5 per tritacarne e convogliatore:
- Hp 1.5 per pala mescolatore/convogliatore
- Hp 5 o Hp 7 per tritacarne 42
- Hp 4 per tritacarne 32
- Riduttori angolari ermetici a bagno d'olio
- Micro di sicurezza su coperchio vasca
- Auto-apertura coperchio gestita da pistoni ad aria
- Comandi in acciaio inox IP 67 con inversione di marcia su TC
- **Gruppo macinazione:**
- Completamente in acciaio inox AISI 304
- Studiato per grandi prestazioni
- Perno trascinatore in acciaio inox
- Perno elica in acciaio temperato
- Smontaggio rapido bocca e pala senza l'uso di attrezzi
- **Esclusivo sistema brevettato di controllo presenza piastra e coltello**

- *AISI 304 stainless steel construction, can be sprayed.*
- *2 independent IP x5 motors for grinder and mixer:*
- *5 Hp or 7Hp meat grinder motors (42 model)*
- *5 Hp or 7Hp meat grinder motors (42 model)*
- *4 Hp meat grinder motor (32 model)*
- *Oil-bath, waterproof angular gear box*
- *Safety microswitch on meat mixer cover*
- *Air pistons open the cover*
- *IP 67 stainless steel controls (reverse available for grinder)*
- **Grinding set:**
- *Completely made of AISI 304 stainless steel*
- *Designed for high performance*
- *Stainless steel drive pin.*
- *Tempered steel worm pin.*
- *Grinding set and mixing arm can be easily disassembled without tools*
- *Exclusive, patented plate and knife detection system*



MASTER 90 Y 12

### Dotazione standard:

- Coltello e piastra diam. 4,5 autoaffilanti inox
- Struttura autoportante con ruote inox con freno
- Attrezzo estrazione elica e piastre

### Standard accessories:

- *Stainless steel self-sharpening knife and 4,5 mm plate*
- *Floor support with stainless steel wheels and brake*
- *Worm and plate removing tool*



MASTER 30 Y12



MASTER 60



Opzionale: sistema di protezione interbloccato per uso piastre con foro > 8 mm.  
*Optional: interlock protection for more than 8 mm holes plates.*



Opzionale: paraspruzzi  
*Optional: splash guard*



Coperchio con sollevamento automatico  
*Lid with self lifting*



Sistema comandi Full Control (per Format S-A)  
*Full Control system (for Format S-A)*



Pedaliera opzionale  
*Optional pedal controls*



P. 121



Funzionamento temporizzato  
 Inversione di marcia temporizzata su pala mescolatore  
 Possibilità di collegamento accessori quali:  
 - pedaliera  
 - hamburgeratrice semiautomatica Format S  
 - hamburgeratrice automatica Format A

*Timer function*

*Reverse with timer for meat mixer*

*Optional connections for:*

- pedal controls
- Format S - semi-automatic hamburger press attachment
- Format A - automatic hamburger press attachment.

**Optional disponibili:**

- Paraspruzzi inox
  - Protezione bocca interbloccata per piastre con foro > 8 mm
  - Bocca unger parziale o totale inox
- Comandi FULL CONTROL con:

**Optional available:**

- Stainless steel splash guard
  - mouth guard interlocked for plates with 8 > mm
  - Stainless steel 1/2 or total unger grinding set
- FULL CONTROL:**



MASTER 90 Y12 con FORMAT S



MASTER 90 Y12 con FORMAT A



Estrattore piastre  
Plates removal tool



Standard o enterprise    1/2 Unger    Unger Totale



**MASTER 90 Y 12**

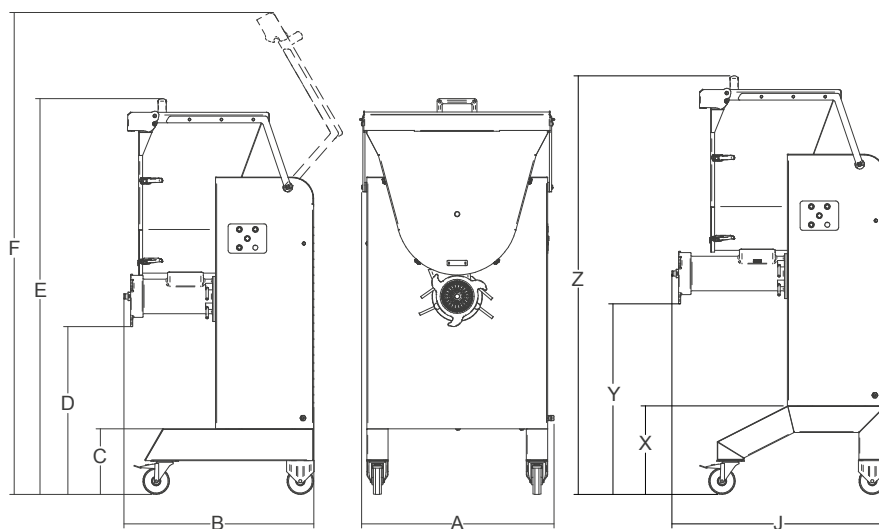

**MASTER 90 Y12**

gambe alte opzionali  
optional high legs  
X: 333 mm / Y: 717 mm  
Z: 1575 mm / J: 806 mm

	watt/HP	watt/HP		kg/lt	ø mm	r.p.m.	kg/h.	mm	mm	mm	mm	mm	mm	kg	mm	kg
<b>Master 30 Y12</b>	2940/4	1102/1,5	1ph/3ph	30-42	4.5	TC200/ IP30	600-850	644	658	247	589	1243	1477	140	870x840x1700	165
<b>Master 60</b>	2940/4	1102/1,5	1ph/3ph	60-80	4.5	TC186/ IP30	850-1000	670	732	247	655	1416	1694	160	870x840x1700	185
<b>Master 90 Hp 5 Y12</b>	3675/5	1102/1,5	1ph/3ph	90-120	4.5	TC186/ IP30	1000-1200	724	714	247	631	1489	1813	191	870x840x1700	216
<b>Master 90 Hp 7 Y12</b>	5145/7	1102/1,5	1ph/3ph	90-120	4.5	TC186/ IP30	1000-1200	724	714	247	631	1489	1813	191	870x840x1700	216





# FORMAT

applicazioni hamburgatrici  
hamburger applications



## Format M

Stampi opzionali / *Optionals moulds*

Applicabile su / *Applicable on*  
COLORADO - BARCELONA - BARCELONA ICE - NEVADA - NEVADA ICE



Ø 100 mm / gr 140 c.



Ø 110 mm / gr 155 c.

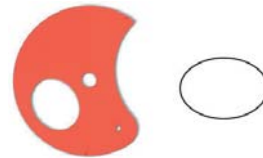

96x115 mm / gr 130 c.



100x100 mm / gr 150 c.



100x125 mm / gr 190 c.



90x117 mm / gr 105 c.



Ø 40 mm / gr 20 (x4) c.



Regolabile 100-200 gr. da tondo a "ovale"  
*Adjustable 100-200 gr. - round to oval*

## Format S

Semiautomatica  
Stampo fisso tondo Ø 100 mm

*Semiautomatic*  
*Round fixed mould Ø 100 mm*

Applicabile su / *Applicable on*  
MONTANA - MASTER



## Format S

## Format A



Automatica  
Stampo fisso tondo:

*Automatic*  
*Round fixed mould*

Ø 95 mm - h. 14 mm  
Ø 100 mm - h. 20 mm  
Ø 110 mm - h. 14 mm

Applicabile su / *Applicable on*  
MONTANA - MASTER





# KATANA 6 - 12 - 20

## cutter orizzontali horizontal cutter

- Completamente realizzato in acciaio inox AISI 304
- Lame guidate da potente motore asincrono ventilato.
- Robusta vasca in acciaio inox AISI 304, smontabile.
- Coperchio interbloccato facilmente smontabile per agevolarne pulizia e sanificazione.
- Comandi con pulsanti inox IP 67.
- Mozzo con 3 lame di serie facilmente rimovibile (configurabile a 2 lame).
- Disponibili mozzi lame specifici per lavorazioni particolari.
- Massima protezione infiltrazione liquidi sull'albero.
- Ideali per carni e verdure ma adatto anche a molteplici altre lavorazioni.

- *Completely made of stainless steel AISI 304*
- *Blade driven by powerful ventilated asynchronous motor.*
- *Sturdy, removable AISI 304 stainless steel bowl.*
- *Easily removable interlocking lid to facilitate cleaning and sanitising.*
- *Controls with IP 67 stainless steel buttons.*
- *Easily removable blade hub with 3 blades standard (configurable to 2 blades).*
- *Dedicated knives available for special purposes.*
- *Maximum protection against liquid infiltration on the shaft.*
- *Perfect for meat and vegetables, but also suitable for many other types of processing.*



KATANA 20



KATANA 12 VV



KATANA 6

### MODELLO 12 PTO

- Disponibile anche con presa di forza per accessori opzionali standard come TC, TV (solo non CE).

### MODELLO 20

- Variatore di velocità continuo gestito da inverter.
- Motoriduttore vasca indipendente.

### MODEL 12 PTO

- Also available with PTO for optional accessories like TC, TV (only non CE).

### MODEL 20

- Continuous speed control controlled by inverter.
- Gearmotor freestanding tub.



KATANA 6

KATANA 12 PTO



**KATANA 12 PTO**  
Tritacarne escluso  
Mincer head not included



**STANDARD**  
Mozzo a 3 lame  
Hub with 3 blades



**OPTIONAL**  
Mozzo a 3 lame dentate  
Hub with 3 serrated blades



**OPTIONAL**  
Mozzo a 3 lame non affilate  
Hub with 3 blunt blades

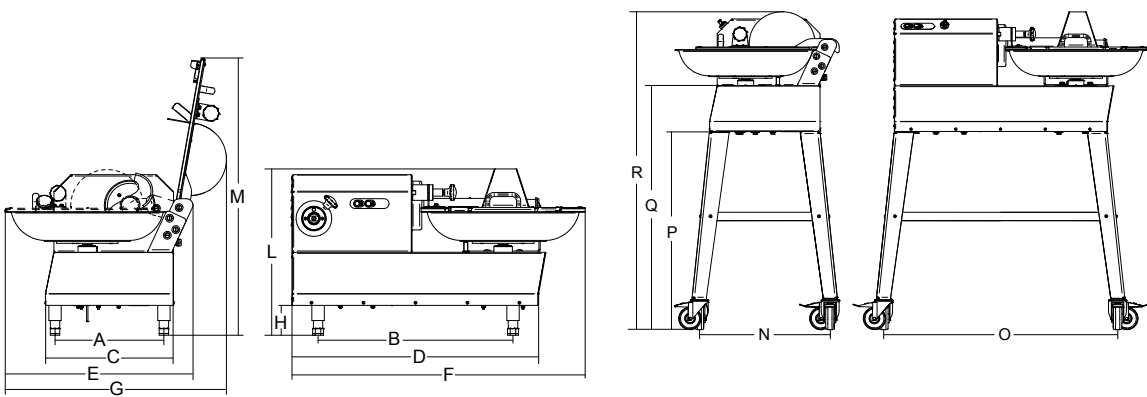

						A	B	C	D	E	F	G	H	L	M	N	O	P	Q	R			
	watt/HP	n.	lt	r.p.m.	mm	mm	mm	mm	mm	mm	mm	mm	mm	mm	mm	mm	mm	mm	mm	mm	kg	mm	kg
<b>Katana 6</b>	370/0.5	1ph	3	6	1440	297	540	356	714	516	832	582	92	472	760	428	776	710	864	1089	61	1200x670x800	79.5
<b>Katana 12</b>	750/1	1ph/3ph	3	12	1440	335	600	393	758	587	902	680	92	508	850	467	836	710	873	1138	71	1200x670x800	89.5
<b>Katana 12 VV</b>	824/1.12	1ph	3	12	600/2.600	335	600	393	758	587	902	680	92	508	850	467	836	710	873	1138	71	1200x670x800	89.5
<b>Katana 12 PTO</b>	750/1	1ph/3ph	3	12	1440	335	600	393	758	587	902	680	92	508	850	467	836	710	873	1138	71	1200x670x800	89.5
<b>Katana 20</b>	2.390/3.25	1ph	3	20	600/2.600	390	650	450	820	700	1013	822	92	572	1010	521	886	710	883	1189	93	1000x1200x800	111.5



**KATANA 20**



# IP 10-20 M

## impastatrici per carne

### meat mixers



- Pratiche e compatte, ideali per piccoli impasti, sia in macelleria che ristorazione.
- Costruzione in acciaio inox Aisi 304.
- Riduttore a bagno d'olio con ingranaggi elicoidali temprati e rettificati.
- Sistema di protezione ingranaggi con doppio paraolio.
- Motori asincroni ventilati IP x5.
- Coperchio con micro di sicurezza.
- Pala in acciaio inox Aisi 304 facilmente rimovibile senza attrezzi.
- Comandi IP54 con inversione.

- *Practical and compact, ideal for small mixing jobs in butcher shops and restaurants.*
- *AISI 304 stainless steel body.*
- *Oil bath gear reducers with hardened and ground helical gears.*
- *Gear box with double sealing system.*
- *IP x5 ventilated, asynchronous motors.*
- *Safety microswitch on the cover.*
- *Removable AISI 304 stainless steel mixing arm (no tools required).*
- *IP54 controls with inversion.*



IP 20 M



IP 10 M

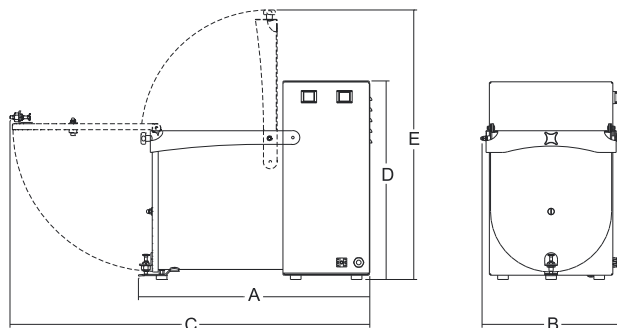

					A	B	C	D	E			
	watt/HP	ph	mm	lt/kg	mm	mm	mm	mm	mm	kg	mm	kg
<b>IP 10 M</b>	180/0.25	1ph	200x250	14/10	472	255	757	410	565	18	800x600x520	20.5
<b>IP 20 M</b>	370/0.5	1ph	270x300	28/20	554	330	845	646	634	27	720x570x770	49



Pala facilmente rimovibile  
Removable mixing arm



# IP 30-50 M Y14



## impastatrici per carne meat mixers



- Costruzione in acciaio inox Aisi 304.
- Potente motore.
- Riduttore a bagno d'olio con ingranaggi elicoidali temperati e rettificati.
- Sistema di protezione ingranaggi con doppio paraolio.
- Coperchio con micro di sicurezza.
- Pala in acciaio inox Aisi 304 facilmente rimovibile senza attrezzi.
- Sportello vasca apribile per rimozione pala e impasto.
- Comandi in acciaio inox IP 67 con inversione.

### Opzioni:

- Gambe inox basse, medie e alte con ruote.
- Tramoggia aggiunta ingredienti.

- *AISI 304 stainless steel body.*
- *Powerful.*
- *Oil bath reducer with hardened and ground helical gears.*
- *Gear box with double sealing system.*
- *Safety microswitch on the cover.*
- *Removable AISI 304 stainless steel mixing arm (no tools required).*
- *Front outlet opening for shaft removal and product unload.*
- *Stainless steel IP 67 protection rated controls with reverse.*

### Options:

- *Short, medium, long legs with wheels.*
- *Feeding tray to add ingredients.*



### IP 50 M Y14

Gambe con ruote opzionali  
Optional legs with wheels



IP 30 M Y14



IP 30 M Y14



**IP 30 M Y14**



Comandi IP 67 in acciaio inox  
Stainless steel IP 67



**IP 50 M Y14**



Opzione tramoggia per aggiunta ingredienti  
Optional feed tray for add ingredients

**IP 30-50 M Y14 optionals**

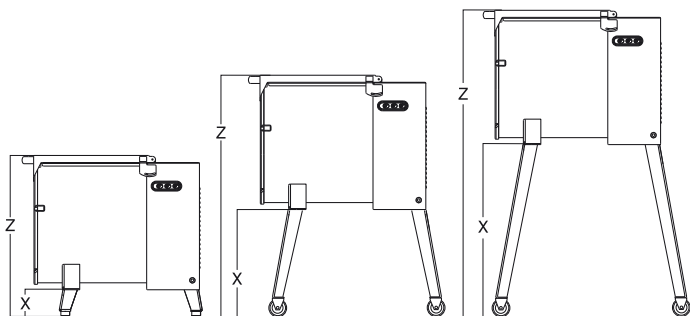

Gambe basse con piedino  
*Short legs with feet*

IP 30 M Y14  
X: 150 mm / Z: 650 mm  
IP 50 M Y14  
X: 150 mm / Z: 720 mm

Gambe medie con ruote e freno  
*Medium legs with wheels and brake*

IP 30 M Y14  
X: 440 mm / Z: 940 mm  
IP 50 M Y14  
X: 440 mm / Z: 1010 mm

Gambe alte con ruote e freno  
*Longer legs with wheels and brake*

IP 30 M Y14  
X: 610 mm / Z: 1110 mm  
IP 50 M Y14  
X: 610 mm / Z: 1180 mm

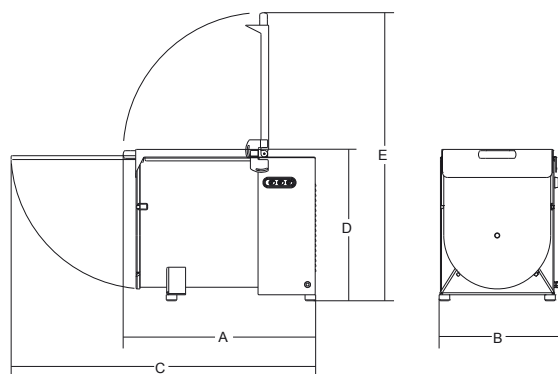

					<b>A</b>	<b>B</b>	<b>C</b>	<b>D</b>	<b>E</b>			
	watt/HP		mm	lt/kg	mm	mm	mm	mm	mm	kg	mm	kg
<b>IP 30 M Y14</b>	1ph 1.100/1,5 3ph 1.472/2	1ph/3ph	300x400	42/30	680	365	1120	530	975	49	720x570x770	59
<b>IP 50 M Y14</b>	1ph 1.100/1,5 3ph 1.472/2	1ph/3ph	410x480	88/50	750	465	1250	595	1120	59	870x840x760	74



# IP 50-80-120-180 XP BA

## impastatrici per carne *meat mixers*



- Moderno design e robusta struttura in AISI 304 a forte spessore.
- Vasca ribaltabile con sistema di blocco automatico e blocco di sicurezza.
- Ruote inox girevoli e con freno (2).
- Sistema classico con 2 alberi affiancati.
- Pale in acciaio inox AISI 304 facilmente rimovibili senza attrezzi.
- Carter con protezione totale della parte riduttori/comandi.
- Riduttore a bagno d'olio con ingranaggi elicoidali temperati e rettificati.
- Protezione dai liquidi a doppio paraolio: su vasca e su riduttore.
- Sistema di controllo con comandi in acciaio inox IP 67 di serie:
  - marcia avanti e indietro
  - automatismo con autospegnimento
  - automatismo con inversione
- Coperchio in acciaio inox con micro di sicurezza.
- Carico minimo 40% capienza vasca.
- Ideale anche per impasti duri e insalate.

### Opzionale:

- Tramoggia aggiunta ingredienti.

- *Modern design and strong AISI 304 stainless steel construction.*
- *Tilting tank with automatic locking system and safety lock.*
- *Stainless steel swivel wheels with lock (2).*
- *Two mixing arms system.*
- *Removable AISI 304 stainless steel mixing arms (no tools required).*
- *Total protection of gear box/control panel.*
- *Oil bath reducer with hardened and ground helical gears.*
- *Double seal on tank and gear box.*
- *Stainless steel IP 67 controls:*
  - *Forward and backward*
  - *auto-off feature*
  - *auto-function with reverse*
- *Stainless steel cover with safety microswitch.*
- *Minimum loading required: 40% max capacity.*
- *Perfect for hard mix and salad.*

### Optional:

- *Feeding tray to add ingredients.*



IP 180 XP BA



Ribaltamento vasca  
Tank overturn



Pale facilmente rimovibili  
Removable mixing arms

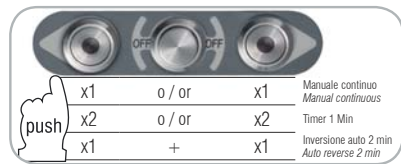

Sistema di controllo  
Control system

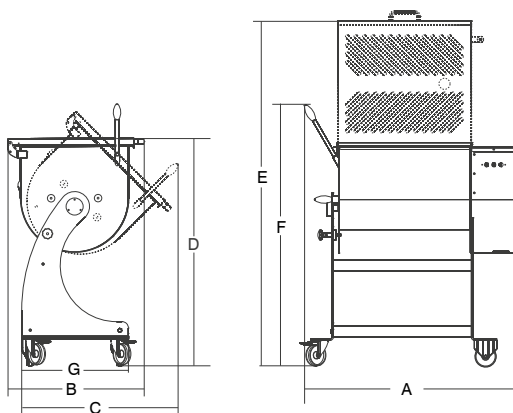

	watt/HP		mm	lt/kg	mm	mm	mm	mm	mm	mm	mm	kg	mm	kg
<b>IP 50 XP BA</b>	1ph 370/0.5(x2) 3ph 530/0.7(x2)	1ph/3ph	420x500	88/50	810	630	730	1030	1617	1220	500	85	1200x670x1300	105
<b>IP 80 XP BA</b>	1ph 370/0.5(x2) 3ph 530/0.7(x2)	1ph/3ph	620x500	110/88	1000	630	730	1030	1617	1220	500	90	1200x670x1300	110
<b>IP 120 XP BA</b>	1ph 750/1(x2) 3ph 1.100/1.5(x2)	1ph/3ph	660x550	163/120	1092	700	855	1030	1717	1209	620	138	1450x750x1300	167
<b>IP 180 XP BA</b>	1ph 750/1(x2) 3ph 1.100/1.5(x2)	1ph/3ph	995x550	250/180	1422	700	855	1030	1717	1209	620	152	1450x750x1300	182



IP 50 XP BA



IP 80 XP BA



IP 120 XP BA



# IS 8-16 X - IS 12 VX

## insaccatrici manuali

### manual sausage stuffers



- Corpo e cilindro in acciaio inox AISI 304.
- Robusto cilindro raggiato e con doppia saldatura sul fondello.
- Pistone in nylon alimentare con valvola di sfogo aria.
- Scatola ingranaggi in acciaio zincato.
- Ingranaggi in acciaio temperato e rettificato.
- Scorrimento ingranaggi su 4 cuscinetti ermetici.
- Sistema riduzione a doppia velocità.
- In dotazione: 3 imbusti in nylon alimentare bianco.
- Morsetto fissaggio.

#### Opzionale:

- Cremagliera in acciaio inox.

- AISI 304 S/S body and cylinder.
- Sturdy cylinder with double welding on the bottom plate.
- Nylon pistons with air exhaust valve.
- Galvanized steel gear box.
- Ground and tempered steel gears.
- Gears sliding on 4 sealed bearings.
- 2 speed gear reducer.
- Included: 3 funnels food white nylon.
- clamp.

#### Optional:

- Stainless steel rack.



IS 8-16 X



IS 12 VX

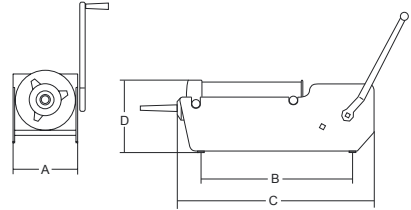
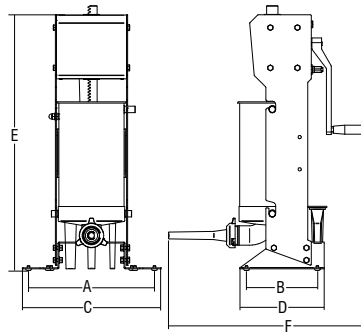

	lt	mm	ø mm	mm	ø mm	mm	mm	mm	mm	mm	mm	kg	mm	kg
IS 8 X	8	370	165	420	10-18-25	200	430	660	220	-	-	19	730x260x250	20
IS 16 X	16	500	200	560	10-18-25	240	575	820	250	-	-	23.5	890x310x280	24.5
IS 12 VX	12	380	200	420	10-18-25	400	190	435	250	794	602	24	890x310x280	26



Porta imbusti  
Holder funnels

Ribaltamento cilindro  
Cylinder overturn



Estrema facilità di pulizia  
Easy to clean



IS 12 VX

IS 8-16 X



# IS 8-16 ARIES

insaccatrici manuali  
manual sausage stuffers



- Corpo e cilindro in acciaio inox AISI 304.
- Robusto cilindro raggiato e con doppia saldatura sul fondello.
- Pistone in nylon alimentare con valvola di sfogo aria.
- Scatola ingranaggi in acciaio zincato.
- Ingranaggi in acciaio temperato e rettificato.
- Scorrimento ingranaggi su 4 cuscinetti ermetici.
- Sistema riduzione a doppia velocità.
- In dotazione: 3 imbuti in nylon alimentare bianco e morsetto fissaggio.

**Opzionale:**

- Cremagliera in acciaio inox.
- AISI 304 S/S body and cylinder.
- Sturdy cylinder with double welding on the bottom plate.
- Nylon pistons with air exhaust valve.
- Galvanized steel gear box.
- Ground and tempered steel gears.
- Gears sliding on 4 sealed bearings.
- 2 speed gear reducer.
- Standard: 3 nylon filling tubes and fixing clamp.

**Optional:**

- Stainless steel rack.



IS 8-16 ARIES



**IS 8-16 ARIES**

Scorrimento su cuscinetti  
Running on ball bearings

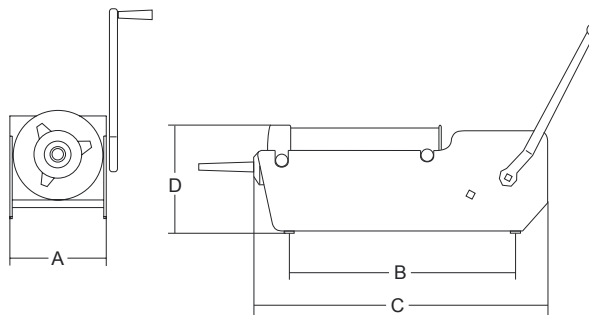

	lt	mm	ø mm	mm	ø mm	mm	mm	mm	mm	kg	mm	kg
IS 8 Aries	8	370	165	420	10-18-25	200	430	660	220	23	730x260x250	24
IS 16 Aries	16	500	200	560	10-18-25	240	575	820	250	28	890x310x280	29

# IS 16-30-50 IDR. ORIZ.

## Insaccatrici orizzontali hydraulic sausage stuffers



IS 30 IDR. ORIZ.



Ribaltamento cilindro  
Cylinder overturn



Protezione cilindro e valvole sfiato  
aria tampone  
Cylinder protection and pad exhaust  
valves

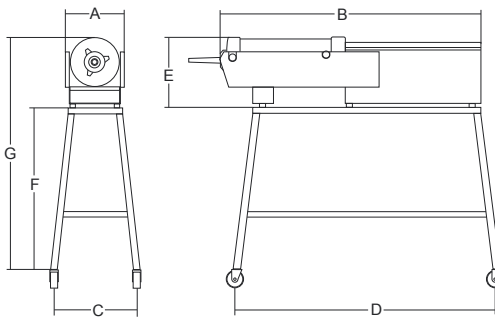

- Macchine insaccatrici di semplice concezione, ma realizzate con materiali e accorgimenti di alta qualità:
- Robusta struttura realizzata in acciaio inox.
- Macchina completamente lavabile mediante spruzzo d'acqua.
- Cilindro in acciaio inox AISI 304 conforme alle recenti norme igienico sanitarie raggiato e senza resto di saldatura interna, per consentire una semplice pulizia.
- Completamente a norme antinfortunistiche con protezione sul cilindro e comando a pedale a bassa tensione.
- Pistoni provvisti di valvole per lo sfato dell'aria.
- Avanzamento pistone regolabile mediante un pomello.
- Ritorno pistone sempre a velocità massima.
- Completa di imbuto in polietilene di tre differenti misure, a richiesta inox.

- *Machines of simple design, but manufactured with high quality materials and details.*
- *Strong structure made of stainless steel.*
- *Completely cleanable by means of a water sprinkle.*
- *Stainless steel AISI 304 cylinder standing to the newest sanitary-hygienic norms, with no edge inside of it and no weld rests, to simplify the cleaning.*
- *Completely realized standing to the most up to date accidental prevention norms, with protection on cylinder and low tension treadle drive.*
- *Pistons provided with air exhaust valve.*
- *Forward feeding adjustable by means of knob.*
- *Backward feeding always at highest speed.*
- *Complete with three polyethylene funnels of different sizes, stainless steel funnels on request.*

											A	B	C	D	E	F	G			
	watt/HP	lt	mm	ø mm	mm	mm	mm	mm	mm	mm	mm	mm	mm	mm	mm	mm	mm	kg	mm	kg
<b>IS 16 Idr. Oriz.</b>	560/0.75	16	500	200	520	330°	30°	16"	10-18-25	280	1310	440	1160	360	780	1120	71	1400x460x550	78	
<b>IS 30 Idr. Oriz.</b>	560/0.75	30	600	260	640	410°	60°	30°	10-18-25	360	1580	440	1010	400	720	1100	111	1620x500x500	120	
<b>IS 50 Idr. Oriz.</b>	560/0.75	50	600	320	650	540°	60°	30°	10-18-25	420	1650	500	1100	430	670	1100	153	1620x500x500	174	



IS 16 IDR. ORIZ.



IS 50 IDR. ORIZ.



# IDRA 15-25-35-50

## Insaccatrici verticali vertical hydraulic sausage stuffers



- Semplici e funzionali, le nuove insaccatrici idrauliche verticali IDRA contano su di un potente impianto idraulico che lavora a 120 Bar di pressione.
- Costruite interamente in acciaio inox, totalmente smontabili per la pulizia senza l'uso di attrezzi, vantano caratteristiche proprie di modelli di classe superiore:
  - coperchio e tampone totalmente in acciaio inox;
  - guarnizioni al silicone che agiscono all'interno del cilindro per una maggiore tenuta e durata della guarnizione stessa;
  - protezione ermetica cilindro oleodinamico;
  - stelo pistone in acciaio inox;
  - cilindro in acciaio inox, lucidato e ribordato, senza verso obbligato;
  - potente e silenzioso motore ventilato a 2.800 giri ad azione immediata;
  - ritorno pistone automatico con spegnimento motore;
  - comandi 24 V;
  - regolatore flusso olio di alta precisione;
  - ruote gommate di serie;
  - serbatoio olio con indicatore di livello.

- *Simple and functional, the hydraulic vertical sausage fillers feature a powerful hydraulic system that operates at a pressure of 120 bars.*
- *Manufactured entirely from stainless steel, the machine can be completely disassembled for easy cleaning without requiring tools. It features characteristics typical of higher category models:*
  - *fully stainless steel cover and piston;*
  - *silicone gaskets that act inside the cylinder for better seal and longer life of the gasket;*
  - *hermetic protection of the hydraulic cylinder;*
  - *stainless steel piston rod;*
  - *polished and rounded stainless steel cylinder, without obligatory direction;*
  - *powerful and silent ventilated motor operating at 2.800 rpm with immediate action;*
  - *automatic piston return when motor stops;*
  - *commands 24 V;*
  - *high-precision oil flow controller;*
  - *standard rubber wheels;*
  - *oil tank with level gauge.*



IS 25 IDRA



Guarnizione ermetica su cilindro oleodinamico  
Hermetic hydraulic piston gasket



Azionamento spinta pistone  
Piston pushing up



Ritorno pistone automatico  
Automatic piston return



Particolare centralina e comandi  
Electric station and controls



IS 15 IDRA



IS 35 IDRA



IS 50 IDRA

Opzionali

Optionals



Ghiera inox  
Bush in stainless steel



Imbuti inox (ø 13-16-20-25-28-38)  
Funnels in stainless steel (ø 13-16-20-25-28-38)

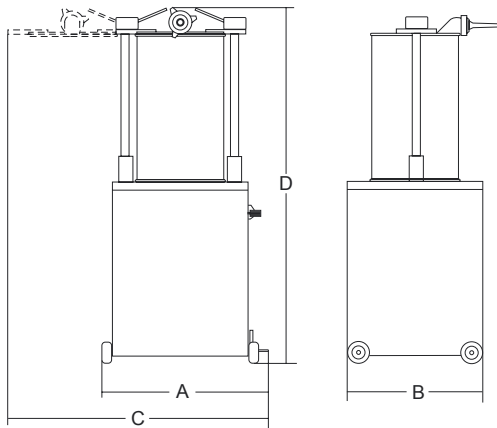

Estrema facilità di pulizia  
Easy to clean

	watt/Hp	lt	mm	ø mm	mm	mm	mm	mm	mm	mm	mm	mm	mm	kg	mm	kg
<b>IS 15 Idra</b>	560/0.75	15	495	200	430	2'11"	59"	35"	10-18-25	490	370	700	1200	53	720x570x1380	63
<b>IS 25 Idra</b>	560/0.75	25	460	260	380	2'02"	51"	32"	10-18-25	565	450	950	1160	91	720x570x1380	103
<b>IS 35 Idra</b>	560/0.75	35	460	320	380	2'02"	51"	32"	10-18-25	640	480	1000	1160	101	760x640x1430	113
<b>IS 50 Idra</b>	560/0.75	55	520	380	440	6'	75"	32"	10-18-25	730	550	1130	1250	145	760x640x1430	160



# SO ALLUMINIO

## segaossa bone saws

- Macchine dalla linea semplice e robusta, sicure e facili all'uso.
- Struttura autoportante realizzata in fusione di alluminio anodizzato, brillante, igienico e anticorrosivo.
- Complete di piano, spingicarne e porzionatrice in acciaio inox AISI 304.
- Comandi 24V con micro di sicurezza su porta, centralina di controllo ridondante e freno motore (CE).
- Massima semplicità e precisione nella regolazione sia orizzontale che verticale della puleggia superiore.
- Massima aderenza della lama alla puleggia grazie alla lavorazione semicurva delle pulegge e ad una perfetta regolazione.
- Cuscinetti ermetici su puleggia superiore.
- Pulizia facilitata grazie a 2 particolari accorgimenti di costruzione:
  - Tutte le parti elettriche sono protette in grado IP x5 o superiore.
  - Semplicemente svitando due manopole è possibile asportare lama, puleggia superiore e supporto della puleggia, si presenta così una superficie priva di ingombri.
- Potenti motori asincroni e ventilati a 4 poli protetti con paraolio di tenuta.
- Utilizzano lame temperate da 16 mm per taglio di ossa, congelato e fresco.

- *Simple and sturdy machines that are safe and easy to use.*
- *Stand-alone structure made out of cast anodized aluminium, shiny, hygienic and rustproof.*
- *Features a counter, meat pusher and serving slicer in stainless steel AISI 304.*
- *24V controls with safety micro-switch on door, redundant ECU and motor brake (EC).*
- *Ease and precision in both horizontal and vertical adjustment of the upper pulley.*
- *Maximum blade adhesion to the pulley, thanks to the semi-curved shape of the pulleys and ideal adjustment.*
- *Sealed bearings on upper pulley.*
- *Smooth cleaning thanks to 2 special manufacturing details:*
  - *All the electrical parts are protected IP x5 or higher.*
  - *By simply unscrewing two knobs, you can remove the blade, upper pulley and its support, thereby making for a surface void of any encumbrance.*
- *Powerful asynchronous and ventilated 4-pole motors protected by sealing oil sump.*
- *Equipped with 16 mm tempered blades for cutting bones, frozen foods and fresh foods.*



SO 1650 -1840 F3

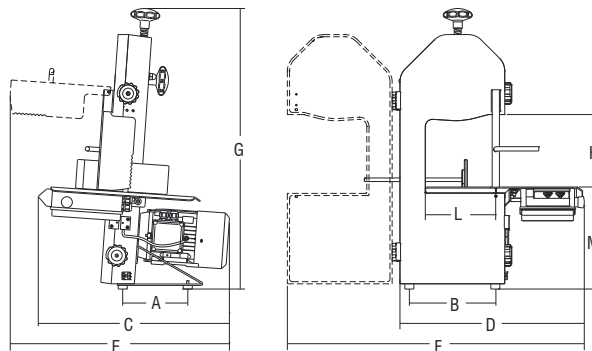

					A	B	C	D	E	F	G	H	L	M			
	mm	Hp/r.p.m.	mm	mm	mm	mm	mm	mm	mm	mm	mm	mm	mm	mm	kg	mm	kg
SO 1550 F3	1550	1ph 1,5/1.400 3ph 2/1.400	210	400x420	180	238	530	510	606	822	778	215	195	269	32	720x570x1200	44
SO 1650 F3	1650	1ph 1,5/1.400 3ph 2/1.400	210	430x475	180	300	530	600	640	950	915	249	200	305	39	720x570x1200	51
SO 1840 F3	1840	1ph 1,5/1.400 3ph 2/1.400	250	430x475	180	300	530	600	640	950	915	249	240	305	40	720x570x1200	52



SO 1650 F3



SO 1840 F3





# SO BREMEN

## segaossa bone saws



SO 1650 BREMEN

- Macchina dalla linea elegante sicura e facile all'uso.
- Struttura autoportante realizzata in fusione di alluminio anodizzato.
- Carenatura motore, sportello e piano di lavoro in acciaio inox AISI 304.
- Completo di spingitore e porzionatrice.
- Puleggia superiore autotensionante con cuscinetti protetti ermeticamente.
- Comandi 24V con micro di sicurezza su porta, centralina di controllo ridondante e freno motore (CE).
- Massima semplicità e precisione nella regolazione della puleggia, sia in altezza che in inclinazione orizzontale e verticale, che permette la più affidabile aderenza della lama.
- Pulizia facilitata grazie alla superficie interna liscia e anodizzata.
- Potenti motori asincroni e ventilati a 4 poli protetti con paraolio di tenuta.
- Utilizzano lame temperate da 20 mm per taglio di ossa, congelato e fresco.

- *Elegant machine, safe and easy to use.*
- *Stand-alone structure made out of cast anodized aluminium.*
- *Motor covering, door and work counter in stainless steel AISI 304.*
- *Features a pusher and serving slicer.*
- *Self-tensioning upper pulley with hermetically guarded bearings.*
- *24V controls with safety micro-switch on door, redundant ECU and motor brake (EC).*
- *Maximum reliability and accuracy when adjusting the pulley, whether its height or horizontal and vertical tilt, which makes for improved blade adhesion.*
- *Smooth cleaning thanks to the polished and anodized inner surface.*
- *Powerful asynchronous and ventilated 4-pole motors protected by sealing oil sump.*
- *The machines use tempered 20-mm blades to shred bone, frozen or fresh.*

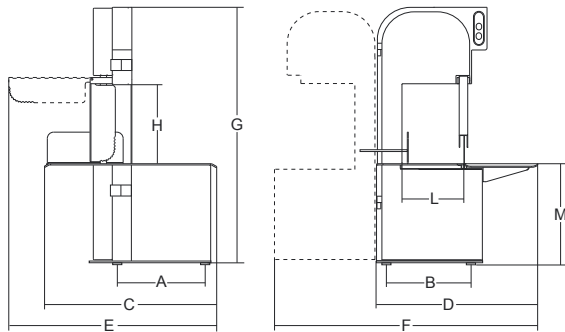

	mm	Hp/l.p.m.	mm	mm	mm	mm	mm	mm	mm	mm	mm	mm	mm	kg	mm	kg	
SO 1650 Bremen	1650	1ph 1,5/1.400 3ph 2/1.400	210	400x500	320	300	500	490	630	810	790	249	200	307	43.5	720x570x1140	55



SO 1650 BREMEN



SO 1650 BREMEN BASIC





# SO INOX

## segaossa bone saws



- Costruzione in acciaio inox AISI 304.
- Cassetto raccogliresti interbloccato e accessibile dall'esterno (non su mod. Start).
- Sportello facilmente rimovibile per agevolare la pulizia (non su mod. Start).
- Pulegge calibrate costruite in alluminio brillantato.
- Cuscinetti ermetici su puleggia superiore.
- Potenti motori asincroni e ventilati protetti con paraolio di tenuta.
- Comandi 24V con micro di sicurezza su porta e cassetto, centralina di controllo ridondante e freno motore (CE).
- Rapido sblocco puleggia superiore agevola la pulizia e il cambio lama.
- Raschiatori facilmente rimovibili e sostituibili.
- Potenti motori a 6 e 8 poli sviluppano grande forza con poco assorbimento (SO2400 e SO3100)
- Motori monofase con protezione termica di serie.
- Lavabili con spruzzo d'acqua (no alta pressione).
- Comandi in acciaio inox IP 67.
- Utilizzano lame temperate da 16 mm per taglio di ossa, congelato e fresco.

### Opzioni:

- Carrello scorrevole (SO 2020-2400-3100).
- Motori veloci per taglio specifico di congelato.
- Puleggia SO1650 inox AISI 304.
- Puleggia SO2400 con bordatura in acciaio inox AISI 304.
- *AISI 304 stainless steel body.*
- *Interlocking scrap pan accessible from the outside (not on model Start).*
- *Easily removable door to facilitate cleaning (not on model Start).*
- *Calibrated pulleys made of polished aluminium.*
- *Sealed bearings on upper pulley.*
- *Powerful asynchronous and ventilated motors protected by lip seals.*
- *Controls (24 V) with safety micro-switch on door and pan, redundancy control unit and motor brake (CE).*
- *Upper pulley with quick-release mechanism to facilitate cleaning and blade change.*
- *Easily removable and replaceable scrapers.*
- *Powerful 6 or 8 pole motors provide great power with little absorption (SO2400 and SO3100)*
- *Single-phase motors with standard thermal protection.*
- *Washable with water jet (no high pressure).*
- *IP 67 stainless steel controls.*
- *Equipped with 16 mm tempered blades for cutting bones, frozen foods and fresh foods.*

### Optionals:

- *Sliding carriage (SO 2020-2400-3100).*
- *High-speed motors designed for cutting frozen foods.*
- *SO1650 pulley steel AISI 304.*
- *SO2400 pulley with AISI 304 stainless steel edging.*



SO 3100 INOX



SO 1650-1840 START

SO 2020 INOX. PAV.

SO 2400 INOX





Cassetto raccolta scarti facilmente estraibile per la pulizia  
Removable wastage tray for easy cleaning.



Raschiatori lama in materiale plastico alimentare ad innesto rapido. Flangia in materiale plastico alimentare nero a tenuta stagna per protezione motore.  
Alimentary plastic blade scraper in quick to insert. Watertight black plastic flange to protect the motor



Pulegge superiori ermetiche  
Hermetic upper pulleys



Piano scorrevole opzionale  
Optional sliding table



Tensionamento lama automatico  
Automatic blade tensioning



SO 2400 INOX SX



Piano scorrevole opzionale ribaltabile  
Optional sliding table folding

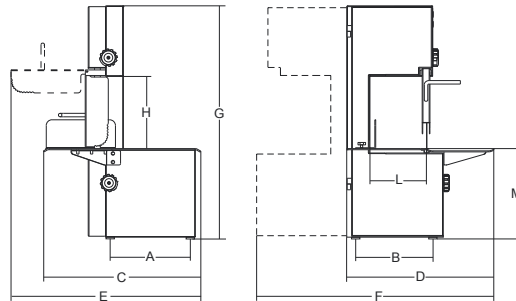

					A	B	C	D	E	F	G	H	L	M			
	mm	Hp/r.p.m.	mm	mm	mm	mm	mm	mm	mm	mm	mm	mm	mm	mm	kg	mm	kg
SO 1650 Inox Start	1650	1,5/1.400	210	400x450	315	314	535	520	640	862	815	249	197	320	46	570x720x1020	58
SO 1840 Inox Start	1840	1,5/1.400	250	440x450	315	334	537	560	640	923	843	249	237	320	51	570x720x1020	63
SO 2020 Inox Start	2020	1,5/1.400	250	480x600	253	346	568	560	710	930	1030	290	236	362	61	570x720x1020	73
SO 1650 Inox	1650	1,5/1.400	210	430x545	342	296	545	510	658	840	816	249	197	320	47	570x720x1020	59
SO 2020 Inox	2020	1,5/1.400	250	480x600	253	346	568	560	710	930	1030	290	236	362	61	760x640x1430	73
SO 2020 Inox. Pav.	2020	1,5/1.400	250	480x600	467	411	568	603	710	930	1650	290	236	980	70	760x640x1750	82
SO 2400 Inox	2400	2,5/900	300	510x710	444	524	715	750	840	1170	1670	350	287	897	100	1050x950x1960	125
SO 3100 Inox	3100	2,7/700	400	795x810	444	624	840	966	950	1485	1900	420	388	947	170	1050x950x1960	195



SO 1650 INOX



SO 2400 INOX





# STERILIZZATORI ELETTRICO E A LIQUIDO

## sterilizzatori sterilizers

### Sterilizz. a liquido

adatti per il magazzinaggio di ogni tipo di coltello, promuovono un'azione disinfettante per mezzo del liquido TEGO SI. Realizzato in acciaio inox e coperchio in polietilene HD bianco.

### Sterilizz. Elettrico coibentato

È dotato di attacchi per acqua in entrata e in uscita, con rubinetto di regolazione e scarico per evitare qualsiasi fuoriuscita del liquido. Temperatura a regolazione costante automatica a 90°C.

### Sterilization. liquid

is suitable for the storage of any kind of knives which are disinfected by means of TEGO SI liquid. Stainless steel body and HD polyethylene cover.

### Sterilization. insulated electrical

is fit with water inlet and outlet connections which are regulated by 2 cocks to avoid any spill. Automatic temperature regulation at 90°C.



STER EL

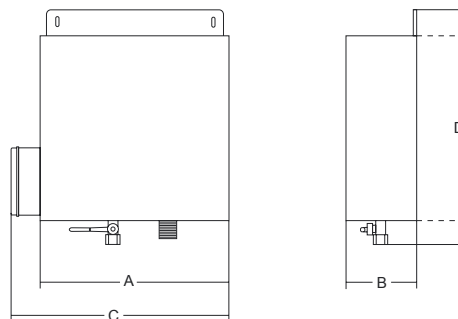

	watt		°C	mm	mm	mm	mm	mm	kg	mm	kg
<b>Ster L</b>	-	-	-	320	400	135	-	35+360	5	420x510x150	6
<b>Ster EL</b>	1.500	1ph	0÷110	270	310	140	390	35+395+70	6.5	470x510x150	7.5



STERILIZZ. A LIQUIDO

# STERILIZZATORI UV

## sterilizzatori

### sterilizers



STER. UV 24W

- Costruiti interamente in acciaio inox AISI 430.
  - Porta in plexiglass fumè che chiude perfettamente la camera.
  - Portacoltelli in plexiglass trasparente totalmente estraibile per una migliore pulizia e consente di sterilizzare i coltelli senza doverli girare.
  - mod. 24W con esclusiva vaschetta di raccolta gocce, incorporata con il portacoltelli.
  - Lampade UV ai vapori di mercurio con protezione in rete metallica.
  - Microinterruttore di sicurezza che spegne le lampade all'apertura della porta e viceversa alla chiusura.
  - Particolare lampada di cortesia per il mod. 24W, che si accende solo se l'interruttore è in posizione "ON" e il timer a "0".
- Made from AISI430 stainless steel.
  - Chamber is closed by a smoked plexiglass door.
  - Removable see-through plexiglass knives holder makes sanitation easier and allows sterilization without having to rotate the knives.
  - Knives holder with built in drops collecting tray (only on 24W version).
  - Mercury vapour lamp UV with wire screen protection.
  - A safety microswitch switches the lamps on when the door is opened and switches them off when it is closed.
  - The courtesy lamp, on 24W model, turns on only when the switch is "on" and the timer is at "0".

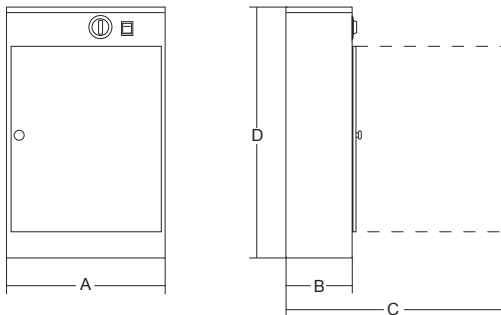
Portacoltelli asportabile su mod. 24 W  
Knife storage unit removable for mod. 24 W

	watt	ph	70 - 0,3A	0 ÷ 120	mm	mm	mm	mm	mm	kg	mm	kg	
<b>Steril. UV 16W</b>	2x8	1ph	70 - 0,3A	0 ÷ 120	15	310	400	140	520	620	9	470x250x700	11
<b>Ster. UV Napoli</b>	2x8	1ph	70 - 0,3A	0 ÷ 120	15	450	400	140	520	760	10	470x250x820	12
<b>Ster. UV 24W</b>	3x8	1ph	100 - 0,5A	0 ÷ 120	20	290	400	300	690	620	14.5	470x400x700	16.5



STER. UV NAPOLI



STERIL. UV 16W



# DRAKE

## inteneritrice bistecche - taglia strisce steak tenderizer - meat strip cutter

- Macchina inteneritrice e taglia strisce per carni e pesce.
- Realizzata in acciaio inox AISI 304.
- Ampia e pratica introduzione prodotto.
- Coperchio facilmente rimovibile per le operazioni di pulizia.
- Facile rimozione e sostituzione del gruppo lame.
- Rulli lame facilmente smontabili per una pulizia più approfondita.
- Doppio sistema di riduzione con cinghia e scatola ad ingranaggi in bagno d'olio.

- *Steak and fish tenderizing and stripes cutting machine.*
- *Stainless steel AISI 304 construction.*
- *Wide feeding income.*
- *Easily removable cover for cleaning purposes.*
- *Blade assembly easily removable and changeable.*
- *Blade drums easily detachable for a deeper sanitification.*
- *Double reducer system with final oil bath gear box.*



Vaschetta inox opzionale  
Optional s/steel tray



Gruppo lame inteneritrice con 96 lame  
Tenderizing blade assembly with 96 blades



Gruppo lame taglio: da 10 mm con 48 lame  
Cutting blade assembly: 10 mm with 48 blades

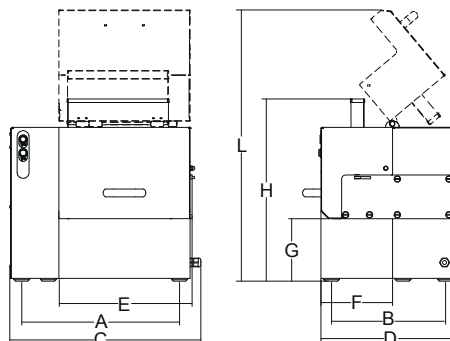

						A	B	C	D	E	F	G	H	L			
	watt/HP	r.p.m.	mm	mm	mm	mm	mm	mm	mm	mm	mm	mm	mm	mm	kg	mm	kg
Drake	370/0.5	1ph	110	250	30x250	397	287	480	390	330	180	157	460	685	31	720x570x800	43





# DRAKE MAN

## inteneritrice bistecche manuale *manual steak tenderizer*



- Inteneritrice per carne a fette.
- Realizzata in acciaio inox AISI 304.
- Introduzione prodotto di ben 25 cm di larghezza, ampia e pratica.
- Protezione lame in acciaio inox.
- Facile rimozione e sostituzione del gruppo lame.
- Rulli lame e pettini facilmente smontabili per una pulizia più approfondita.
- Manopola adattabile per operatori mancini.
- Gruppo inteneritore incluso nel prezzo.

- *Manual operated steak tenderizer.*
- *Stainless steel AISI 304 construction.*
- *Feeding hopper 25 cm wide, best in its class.*
- *AISI 304 blade protection shields.*
- *Blade assembly easily removable and changeable.*
- *Easily removable combs and blade assembly for a deeper sanitation.*
- *Switchable handle for left-handed operators.*
- *Tenderizing blade assembly included.*

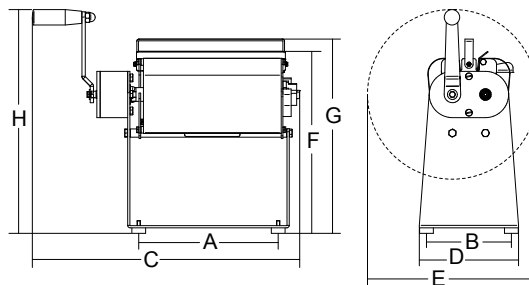

	mm	mm	mm	mm	mm	mm	mm	mm	mm	mm	kg	mm	kg
<b>Drake Man.</b>	250	30x250	253	154	485	180	330	353	308	406	9	-	-

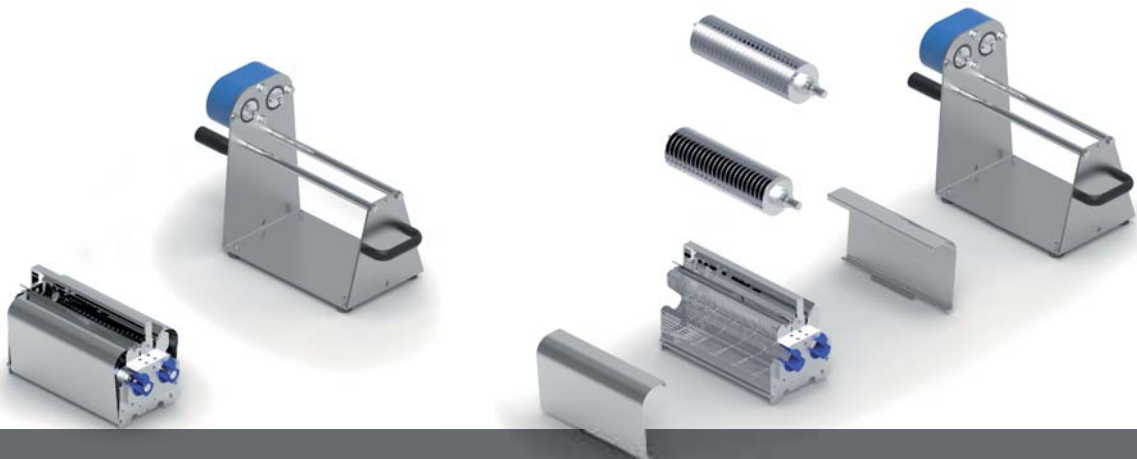



# T-REX

## inteneritrici tenderizers



### T-REX

- Tutti i particolari solo in acciaio inox.
- Molle di ritorno totalmente protette da sporco e liquidi.
- Facile smontaggio e pulizia del gruppo coltelli.
- Piano in polietilene con movimento libero.
- Scorrimento su boccole in tecnopolimero.
- Scorrimento su aste inox 304 rettificata.

- *Stainless steel body and details.*
- *Totally covered springs protected from dirt and liquids.*
- *Quick blade disassembling for easy cleaning.*
- *Mobile polyethylene cutting board.*
- *Sliding on tecnopolymer bushes.*
- *Sliding on s/s aisi 304 grinded shafts*

### T-REX AUTOMEC

- Pacco lame 213 x 80 x h. 62 mm.
- Motorizzazione con sistema a biella.
- Piano mobile a mezzo leva esterna alla protezione.
- Protezione interbloccata rimovibile.
- Scorrimento su boccole in tecnopolimero.
- Totalmente inox.
- Facile smontaggio lame.
- Lame sostituibili anche singolarmente.
- *Dimensions of the blades set: 213x80xh. 62 mm.*
- *Drive with connecting rod system.*
- *Movable cutting board by an external lever.*
- *Removable interlocking system.*
- *Sliding on tecnopolymer bushes.*
- *Completely made from stainless steel.*
- *Easy removable blades.*
- *Individually replaceable blades.*



Facilmente rimovibili  
Easily removable









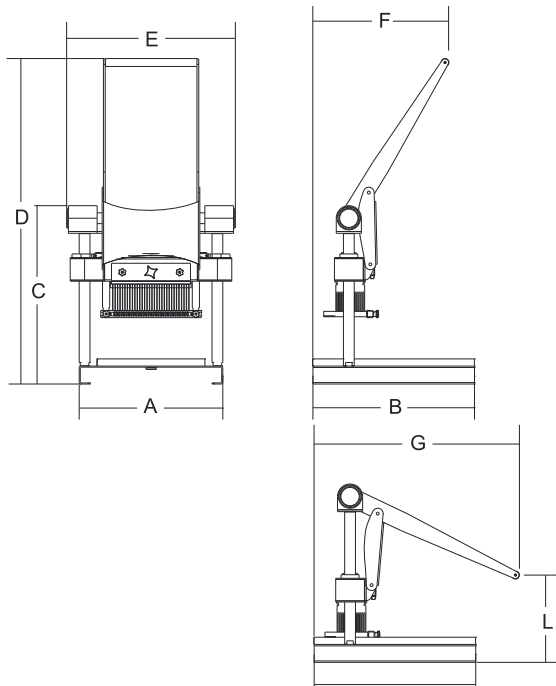



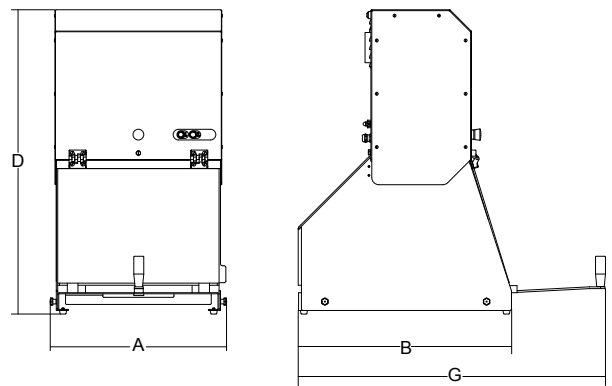







Piano in polietilene con movimento libero  
Mobile polyethylene cutting board

T-REX



T-REX AUTOMEC



																
	watt		mm	mm	n.	mm	mm	mm	mm	mm	mm	mm	mm	kg	mm	kg
<b>T-Rex</b>	-	-	216x280x100	300x450	32	400	450	497	907	470	378	572	243	25	720x770x570	35
<b>T-Rex Automec</b>	550/0,75	1ph	216x280x100	300x430	32	496	601	-	867	-	-	865	-	63	670x600x1200	75



# SA

## hamburgatrici hamburger presses

- Hamburgatrici caratterizzate da una forma arrotondata semplice e compatta.
  - Realizzate in lega di alluminio anodizzato.
  - Contenitore porta cellophane incorporato pronto per l'uso.
  - Piedini in gomma.
- *Simple and compact patty press with rounded design.*
  - *Made from anodized aluminium alloy.*
  - *Cellophane sheet container built in, ready for use.*
  - *Rubber feet.*



SA 150-180

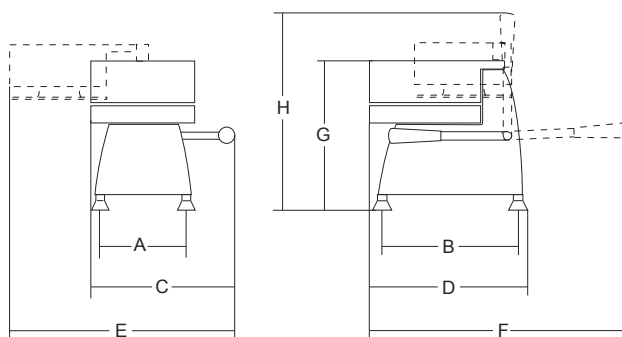

		A	B	C	D	E	F	G	H			
	mm	mm	mm	mm	mm	mm	mm	mm	mm	kg	mm	kg
<b>SA 100</b>	100	140	230	255	270	310	380	260	320	4.5	450x370x350	5.5
<b>SA 110</b>	110	140	230	255	270	310	380	260	320	4.7	450x370x350	5.7
<b>SA 130</b>	130	140	250	260	310	360	460	275	360	6	450x370x350	7
<b>SA 150</b>	150	140	260	260	330	380	460	275	360	6.5	450x370x350	7.5
<b>SA 180</b>	180	140	260	265	330	430	500	275	360	7	450x370x350	8



SA 130



SA 100 - 110



# CEPPI - TAVOLI - PIANI

## CHOPPING BLOCKS - WORKING TABLES - WORKING SURFACES



Tavoli  
Tables

- Adatti per la lavorazione di carne, pesce, verdure e di tutti gli alimenti in genere, sono indispensabili nelle macellerie, nelle pescherie, nei salumifici, nelle industrie alimentari e nelle cucine di alberghi e ristoranti.
- Piani in polietilene HD non assorbono, sono antibatterici e facilmente lavabili.
- Non deteriorano il filo dei coltelli.
- Tavoli con strutture in tubo di alluminio anodizzato mm 50x50 rinforzate internamente con acciaio zincato per una maggiore stabilità e robustezza.
- Disponibili sia nelle versioni standard che su misura e con sottopiani opzionali, sono facilmente montabili e smontabili per un minimo ingombro di spedizione.
- *Suitable for processing meat, fish, vegetables and any kind of products. Cutting boards are essential in butchers', fishmongers', meat processing factories, food processing industries, hotel and restaurant kitchens.*
- *HD polyethylene cutting boards are non-absorbent, antibacterial and easy to clean.*
- *Knives are not damaged.*
- *Working table frame is made from anodized aluminium tubes (50X50 mm) reinforced with galvanized steel for a better stability and sturdiness.*
- *Available both standard or cut to size, with or without base shelf. Tables can be easily assembled and disassembled for minimum shipping dimensions.*



CEPPI IN POLIETILENE  
*Polyethylene chopping blocks*



Pesce / Fish  
Pollo / Chicken  
Verdure / Vegetables  
Carne / Meat  
Carne di cavallo / Horse meat

PIANI IN POLIETILENE CON LISTELLO  
*Polyethylene sheet*



## IMBALLAGGIO

Prolungare la vita di un prodotto, migliorarne la presentazione, conservabilità e trasportabilità.

Questi gli obiettivi delle macchine sottovuoto e imballaggio di Sirman nel rispetto delle caratteristiche intrinseche ai prodotti trattati, per poterne conservare prelibatezza e sapori.

Tutte le macchine sono studiate per garantire prestazioni superiori con la massima ergonomia, semplicità d'uso e sanificazione.

## PACKAGING MACHINES

*Extending a product's shelf life, improving presentation, storability and transportability without altering the inherent characteristics of the treated products, preserving delicacy and flavour.*

*These are the goals of Sirman packing and vacuum packing machines.*

*All machines are designed to deliver superior performance with improved ergonomics, ease of use and sanitation.*



Produced by



GAS

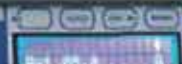

TARE

MODE



# SIGIX M20

## sigilla vaschette thermosealers

- Pratica e robusta sigillavaschette manuale
- Struttura in acciaio inox AISI 304
- Controllo elettronico con temperatura e preriscaldamento
- Conteggio vaschette
- Tempo di saldatura 4 secondi
- Massima dimensione vaschetta mm 260x190
- Stampi custom a disegno
- Piastra sigillante in alluminio teflonato
- Massima larghezza film mm 200.

### Opzionali:

- Vaschette disponibili
- mm 137x95 h.63
- mm 190x137 h.72
- mm 230x190 h.65
- mm 260x190 h.65
- Stampi relativi alle vaschette disponibili.

- *Practical and robust manual Thermosealers*
- *stainless steel AISI 304*
- *Electronic control with temperature and preheat*
- *counting trays*
- *welding time 4/2*
- *Maximum tray size 260x190 mm*
- *Molds to custom design*
- *aluminum plate sealer Teflon*
- *Maximum film width 200 mm.*

### Options:

- *available trays*
- *mm 137x95 h.63*
- *mm 190x137 h.72*
- *mm 230x190 h.65*
- *mm 260x190 h.65*
- *Molds of the available trays.*

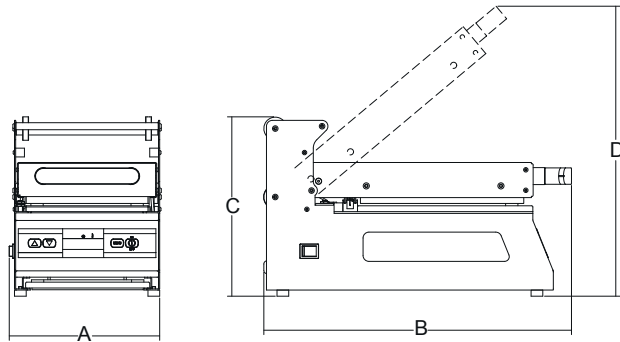

	watt	ph	mm	mm	mm	mm	mm	mm	kg	mm	kg
<b>Sigix M20</b>	900	1ph	200	260x190	257	525	306	496	18	620x380x400	22





# DISPENSER

## dispenser shrink wrappers

- Ideati per il confezionamento di alimenti come carne, formaggio, pasta, frutta e verdura freschi; i dispenser offrono un servizio veloce e igienico nei supermercati, macellerie e gastronomie in genere, dove il commercio di prodotti freschi richiede un confezionamento giornaliero veloce e sicuro.
- Struttura in acciaio inox.
- Rulli e astine in alluminio anodizzato.
- Taglio del film per mezzo di un filo caldo a bassa tensione per i modelli 40M, 50M2 e 51M.
- Profilo teflonato per i modelli 50MBT e 51MB (non provoca fumo).
- *Designed for packaging foods like meat, cheese, pasta, fresh fruits and vegetables; the dispensers offer a fast hygienic service in supermarkets, butcher shops and delicatessens where fresh products retail needs a quick and safe daily packaging.*
- *Structure in stainless steel.*
- *Reels and rods made of anodized aluminum.*
- *Cutting of the film by means of a hot wire at low voltage for 40M, 50M2 and 51M.*
- *teflon coated section 50MBT and 51MB models (does not smoke).*



P. 251-253



51M



Particolare filo caldo (1)  
Heated cutting tread (1)

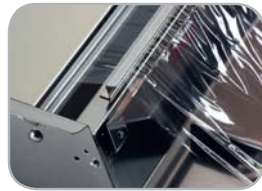

Profilo teflonato (2)  
Teflon-coated section (2)

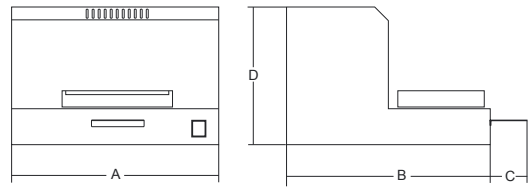

	kw	1ph	(1)	mm	mm	mm	mm	mm	kg	mm	kg	
40M	115	1ph	(1)	400	290x165	465	500	125	290	12.5	580x600x370	14
50M2	115	1ph	(1)	500	290x165	590	540	125	290	14	650x580x370	15.5
50MBT	190	1ph	(2)	500	290x165	590	540	125	290	14	650x580x370	15.5
51M	115	1ph	(1)	500	300x175	590	720	130	185	14.5	780x670x270	16
51MB	190	1ph	(1)	500	300x175	590	720	130	185	14.5	780x670x270	16



51MB



50M2



40M

# EASYVAC

## sottovuoto vacuum packaging machines

- Macchina compatta e veloce, dedicata a piccole porzioni, ideale abbinamento a strumenti di cottura a bassa temperatura tipo Softcooker.
- Facile settaggio del tempo di vuoto e di saldatura.
- Barra saldante facilmente rimovibile.
- Pompa aspirazione Busch.
- Visualizzazione percentuale vuoto e tempo residuo.
- Memorizzazione ultima impostazione.
- Contacikli utilizzo totale.
- Preriscaldamento pompa e ciclo pulizia olio
- Messaggio cambio olio.
- Vuoto esterno a tempo.
- Sollevamento coperchio manuale.

- *compact and fast machine, dedicated to small portions, ideal combination with cooking tools low temperature type Softcooker.*
- *Easy setting of vacuum time and welding.*
- *easily removable sealing bar.*
- *Busch vacuum pump.*
- *Display percentage vacuum and remaining time.*
- *Storing last setting.*
- *Total cycle counter use.*
- *Preheat cycle pump and cleaning oil*
- *oil change message.*
- *External vacuum time.*
- *Manual lid lifting.*



EASYVAC 40 BX



EASYVAC 25 BX



EASYVAC 30 BX







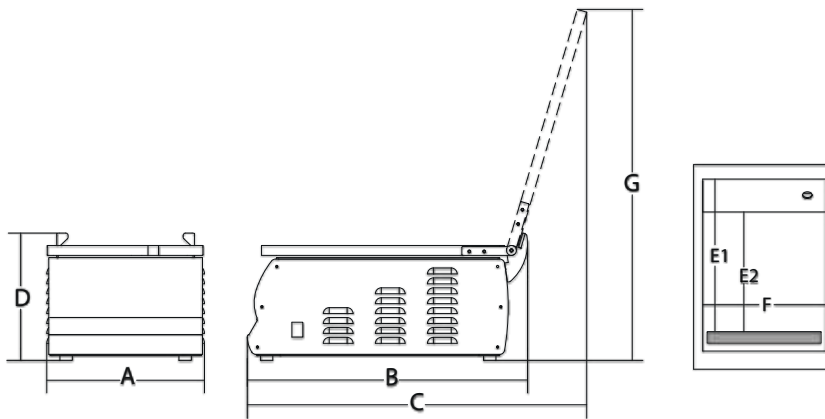

EASYVAC 40 BX



Tubo per aspirazione esterna opzionale  
External suction hose optional



															
	watt	1ph	mc/h	mm	mm	mm	mm	mm	mm	mm	mm	mm	kg	mm	kg
<b>Easyvac 25 BX</b>	0.1	1ph	4	260	270x350 h.75	320	560	685	257	340	263	264	30	660x420x310	32
<b>Easyvac 30 BX</b>	0.1	1ph	4	310	336x378 h.75	406	656	685	315	335	246	336	37	660x740x610	46
<b>Easyvac 40 BX</b>	0.35	1ph	8	410	426x438 h.75	494	637	755	315	395	308	426	42.5	660x740x610	51.5



# W8 30-40-50-70

## sottovuoto vacuum packaging machines



- Straordinario design riduce l'ingombro della macchina e migliora la praticità
- Campana a grande sviluppo di volume in plexiglass termoformato di grosso spessore sui mod. 50 e 70, ad iniezione sui mod. 30 e 40
- Barra saldante facilmente rimovibile
- Estrema facilità di pulizia grazie alla perfetta planarità del piano di appoggio prodotto.
- Sollevamento coperchio automatico a mezzo di pistoncini pneumatici.

### Sistema di controllo elettronico con sensore di pressione:

- selezione 6 lingue
- impostazione tempo saldatura, vuoto e gas con scala 1/10 sec.
- visualizzazione percentuale vuoto e tempo residuo
- 10 programmi memorizzabili a piacere
- programma AA = vuoto automatico
- programma AL = vuoto automatico per liquidi
- programma XT = aspirazione esterna a tempo
- programma XA = aspirazione esterna automatica
- Percentuale vuoto automatico regolabile 50-100%
- Segnale di avviso sostituzione olio e filtro.
- Protezione termica pompa.
- Ciclo di preriscaldamento e pulizia olio.
- Contacigli totali.
- Contatore utilizzo pompa.
- Piano per buste con liquidi.
- Pompa aspirazione Bush.
- Piano posizionamento prodotto in acciaio inox
- AISI 304 spessore 5 mm.

### ACCESSORI OPZIONALI:

- Impianto per gas inerte (MAP) e soft air.
- Stampante termica automatica per data, ora dati confezionamento.
- Tubo per aspirazione esterna.
- Vasche GN per aspirazione esterna.
- Ripiano in plexiglass trasparente.



**W8 40 BX**

con gas inerte e soft air opzionali  
with inert gas and soft air optional

- *Extraordinary design reduces the footprint of the machine and improves comfort*
- *Bell in great development of volume plexiglass thermoformed thick on mod. 50 and 70, injection on mod. 30 and 40*
- *easily removable sealing bar*
- *Extremely easy to clean thanks to the perfect flatness of the support product plan.*
- *Automatic lifting the lid by means of pneumatic pistons.*

### electronic control system with proximity sensor

- 6 selectable languages.
- Settable sealing, vacuum and gas time on a scale 1-10 sec.
- Display of vacuum percentage and time to countdown.
- 10 different settings savable to preference
- Setting AA = automatic vacuum
- Setting AL = automatic vacuum for liquids

- *Setting XT = timed external suction*
- *Setting XA = automatic external suction*
- *Adjustable automatic vacuum percentage: 50-100%.*
- *oil and filter change warning light.*
- *Thermal pump guard*
- *Oil preheat and cleaning cycle*
- *Total rev counter*
- *Pump meter*
- *Surface for liquid bags*
- *Busch suction pump.*
- *5 mm thick, AISI 304 stainless steel, easy to clean plain vacuum chamber.*
- *5 mm thick, AISI 304 stainless steel, easy to clean plain vacuum chamber.*

### OPTIONAL ACCESSORIES:

- Inert gas system (MAP) and soft air
- Automatic thermal printer by date, time and packing specifications
- Hose for external suction
- GN tanks for external suction.
- Plexiglass support.



W8 40 BX



W8 50 DX



W8 50 BX DB





Estrema facilità di pulizia  
Easy to clean



W8 70 BX TB

**W8 30-40 Easy**

- Facile settaggio del tempo di vuoto e di saldatura.
- Visualizzazione percentuale vuoto e tempo residuo.
- Memorizzazione ultima impostazione.
- Contacicli e contatore utilizzo pompa.
- Preriscaldamento pompa e ciclo pulizia olio.
- Messaggio cambio olio e filtro.
- Vuoto esterno a tempo.
- Non disponibile con stampante o Gas.
- Campane ad iniezione con grande sviluppo di volume.
- Sollevamento coperchio automatico a mezzo di pistoncini pneumatici.
- Barra saldante facilmente rimovibile.

**W8 30-40 Easy**

- Easy setting of vacuum time and welding.
- Display percentage vacuum and remaining time.
- Storing last setting.
- Counter and counter use pump.
- Preheating pump and oil cleaning cycle.
- Oil and filter change message.
- External vacuum time.
- Not available with printer or Gas.
- Bells injection with great volume growth.
- Automatic lifting the lid by means of pneumatic pistons.
- easily removable sealing bar.



W8 30 EASY DX



W8 40 EASY BX



W8 40 EASY BX



Controllo elettronico semplice ed intuitivo  
*Simple and intuitive electronic control*



Controllo elettronico mod. Easy semplice ed intuitivo  
*Mod electronic control. simple and intuitive Easy*



Sistema sospensione coperchio ammortizzato  
*Lid damper suspension system*



Stampante integrata opzionale  
*Optional built-in printer*



Barra saldante standard  
*Single sealing bar*



Doppia barra saldante W8 50 DB  
*Double sealing bar W8 50 DB*



Tripla barra saldante W8 70 TB  
*Triple sealing bar W8 70 TB*



Opzione gas inerte e soft air (escluse le Easy)  
*Option inert gas and soft air (the Easy excluded)*



Piano per buste con liquidi di serie (escluso le W8 50 DB e le W8 70 TB)  
*Plan envelopes with standard liquids (excluding DB W8 50 and W8 70 TB)*



Cavalletto alluminio per W8 50 - opzionale con e senza ruote - mm 586x564 h.757  
*Aluminium tripod to W8 50 - optional with or without wheels - mm 586x564 h.757*





Tubo per aspirazione esterna opzionale  
External suction hose optional



Contenitori GN 1/1 - 1/2 - 1/3 (h.100/150)  
opzionale  
Containers GN 1/1 - 1/2 - 1/3 (h.100 / 150)  
Optional



Ripiano in plexiglass opzionale  
Plexiglass Optional shelf



Facile manutenibilità  
easy maintainability



Buste per sottovuoto lisce  $\mu\text{m}$  70  
Vacuum bags smooth  $\mu\text{m}$  70

cm 20x30  
cm 25x35  
cm 30x40  
cm 40x50

Buste per sottovuoto lisce  $\mu\text{m}$  90  
Vacuum bags smooth  $\mu\text{m}$  90

cm 17x25  
cm 20x30  
cm 25x35  
cm 30x40  
cm 35x45  
cm 40x50

Buste per sottovuoto goffrate  $\mu\text{m}$  105  
Vacuum bags embossed  $\mu\text{m}$  105

cm 20x30  
cm 25x35  
cm 30x40  
cm 35x45  
cm 40x50

Buste per cottura sottovuoto  $\mu\text{m}$  90  
Cooking vacuum bags  $\mu\text{m}$  90

cm 15x20  
cm 20x30  
cm 25x35  
cm 30x40

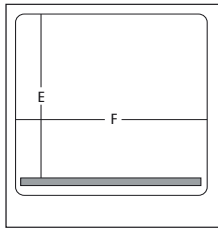

W8 30-40-50

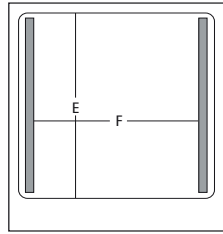

W8 50DB

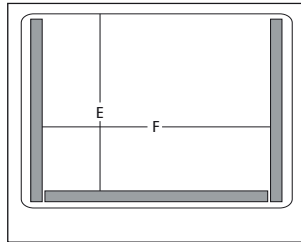

W8 70TB

IDENTIFICAZIONE MODELLI

- D = Pompa DVP
- B = Pompa Busch
- X = piano appoggio inox 5 mm
- 12 = pompa aspirazione 12 mc
- DB = doppia barra saldante
- TB = tripla barra saldante
- P = da pavimento

ORDERING SYSTEM

- D = DVP
- B = Pump Busch
- X = 5 mm flat steel support
- 12 = suction pump 12 mc
- DB = double sealing bar
- TB = Triple sealing bar
- P = floor standing

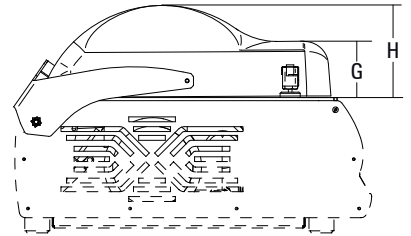
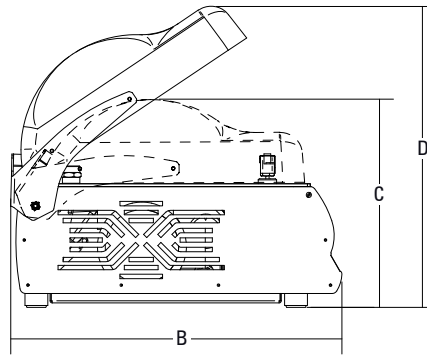
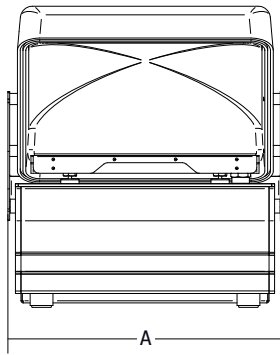

	kw		mc/h	mm	mm	mm	mm	mm	mm	mm	mm	mm	mm	kg	mm	kg
W8 30 Easy DX	0.35	1ph	8	310	340x360 h.160	402	525	408	587	334	340	95	170	38	720x570x770	48
W8 30 Easy BX	0.35	1ph	8	310	340x360 h.160	402	525	408	587	334	340	95	170	38	720x570x770	48
W8 30 Easy DX 12	0.45	1ph	12	310	340x360 h.160	402	525	408	587	334	340	95	170	38	720x570x770	48
W8 30 DX	0.35	1ph	8	310	340x360 h.160	402	525	408	587	334	340	95	170	38	720x570x770	48
W8 30 BX	0.35	1ph	8	310	340x360 h.160	402	525	408	587	334	340	95	170	38	720x570x770	48
W8 30 DX 12	0.45	1ph	12	310	340x360 h.160	402	525	408	587	334	340	95	170	38	720x570x770	48
W8 40 Easy DX 12	0.45	1ph	12	410	430x410 h.170	493	585	422	630	334	430	99	180	54	760x640x770	66
W8 40 Easy DX	0.75	1ph	21	410	430x410 h.170	493	585	422	630	334	430	99	180	56	760x640x770	66
W8 40 Easy BX	0.75	1ph	21	410	430x410 h.170	493	585	422	630	334	430	99	180	56	760x640x770	66
W8 40 DX	0.75	1ph	21	410	430x410 h.170	493	585	422	630	390	430	99	180	56	760x640x770	66
W8 40 BX	0.75	1ph	21	410	430x410 h.170	493	585	422	630	390	430	99	180	56	760x640x770	66
W8 50 DX	0.75	1ph	21	510	545x460 h.190	609	640	420	605	430	540	90	210	70	840x870x750	86
W8 50 BX	0.75	1ph	21	510	545x460 h.190	609	640	420	605	430	540	90	210	70	840x870x750	86
W8 50 DX DB	0.75	1ph	21	410x2	545x460 h.190	609	640	420	605	424	428	90	210	75	840x870x750	87
W8 50 BX DB	0.75	1ph	21	410x2	545x460 h.190	609	640	420	605	424	428	90	210	75	840x870x750	87
W8 70 DX 40 TB	1.1	3ph+N	40	640x1 / 410x2	780x490 h.190	877	674	1134	1368	424	660	95	200	167	1200x800x1350	180
W8 70 BX 40 TB P	1.1	3ph+N	40	640x1 / 410x2	780x490 h.190	877	674	1134	1368	424	660	95	200	167	1200x800x1350	180



# VACUEX 4 - 8

sottovuoto esterno

external packaging machines



- Macchina dedicata all'aspirazione esterna, piccola compatta e pratica nell'utilizzo.
- Ottima portabilità grazie alla pratica maniglia superiore.
- Pompa aspirazione Bush di serie.
- Facile settaggio del tempo di vuoto.
- Contacicl e contaore utilizzo pompa.
- Ciclo di preriscaldamento e pulizia olio.
- Messaggio cambio olio e filtro pompa.
- Filtro su tubo di aspirazione per evitare l'aspirazione di corpi solidi.
- Cartuccia filtro su tubo di aspirazione facilmente sostituibile.

- *The ideal machine for container vacuum, very compact and user friendly.*
- *Easy to carry thanks to the upper handle.*
- *Bush suction pump as standard.*
- *Easy vacuum time setting.*
- *Counter and counter use pump.*
- *Oil preheat and cleaning cycle*
- *Oil and filter change message.*
- *Hose filter to avoid suction of solid parts.*
- *Hose filter cartridge easily removable.*

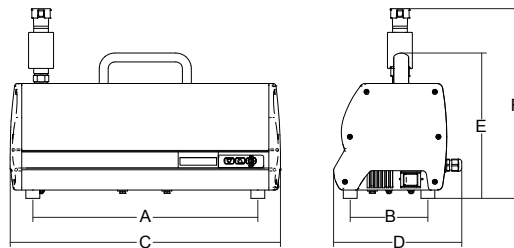

				A	B	C	D	E	F			
	kw	1ph	mc/h	mm	mm	mm	mm	mm	mm	kg	mm	kg
<b>Vacuex 4</b>	0.35	1ph	4	406	140	488	232	262	343	16	550x300x300	18
<b>Vacuex 8</b>	0.35	1ph	8	406	140	488	232	262	343	16	550x300x300	18

## MACCHINE COTTURA

Indispensabili accessori e nuove tecnologie completano il catalogo Sirman di un pacchetto di macchine specifiche per la cottura.

Dalle insostituibili salamandre e pratici forni a convezione, fino alle tecnologie più evolute come induzione e cottura a bassa temperatura.

Dove tradizione e innovazione trovano un perfetto connubio, a supporto di chef professionisti che pretendono sempre il massimo dalle proprie attrezzature.

## COOKING MACHINES

*Essential equipments and new technologies complete the Sirman catalogue with a range of machines specifically designed for cooking.*

*From the unique salamanders and easy to use convection ovens to the most advanced technologies such as induction and low temperature cooking.*

*Here is a perfect match between tradition and innovation, supporting professional chefs who always require the highest performance from their equipments.*







# EASYSOFT

## sottovuoto e cottura a bassa temperatura packaging machine and low temperature cooking



Magnifico connubio tra macchina per il sottovuoto a campana e apparecchio cottura a bassa temperatura.

- Macchina sottovuoto compatta e veloce, dedicata a piccole porzioni
- Facile settaggio del tempo di vuoto e di saldatura.
- Barra saldante facilmente rimovibile.
- Pompa aspirazione a bagno d'olio.
- Visualizzazione percentuale vuoto e tempo residuo.
- Memorizzazione ultima impostazione.
- Contacicli e contatore utilizzo pompa.
- Preriscaldamento pompa e ciclo pulizia olio
- Messaggio cambio olio.
- Vuoto esterno a tempo.
- Sollevamento coperchio manuale.
- Vasca in acciaio inox AISI 304.

*Fantastic combination of a chamber vacuum packing machine and a low temperature cooking device.*

- *Quick compact vacuum packing machine for small servings.*
- *Easy setting of vacuum time and welding.*
- *easily removable sealing bar.*
- *Oil bath suction pump.*
- *Display percentage vacuum and remaining time.*
- *Storing last setting.*
- *Cycles counter and pump usage counter.*
- *Preheat cycle pump and cleaning oil*
- *oil change message.*
- *External vacuum time.*
- *Manual lid lifting.*
- *Aisi 304 stainless steel tray.*



- Apparecchio statico per la cottura a bassa temperatura.
- Potenti resistenze corazzate a contatto nel fondo della vasca.
- Vasca in acciaio inox AISI 304.
- Sistema elettronico di controllo della temperatura con visualizzazione di temperatura e tempo di esercizio.
- Stesso sistema di controllo del Softcooker con  $\Delta T$  di 0,2°C:
- 5 programmi memorizzabili.
- Temperatura selezionabile in °C e °F.
- Coperchio vasca fornito di serie.
- Allarme sonoro raggiunta temperatura.
- Allarme sonoro fine tempo cottura.

- *Static appliance for low temperature cooking.*
- *Powerful armoured contact heating elements in the bottom of the tank.*
- *Aisi 304 stainless steel tray.*
- *Electronic temperature control system with temperature and operating time display.*
- *Same control system of the Softcooker with  $\Delta T$  of 0.2° C.*
- *5 storable programs*
- *Temperature setting in °C and °F.*
- *Equipped with lid*
- *Audible alarm when temperature reached.*
- *Audible alarm at end of cooking time.*







Controllo elettronico semplice ed intuitivo  
simple and intuitive electronic control



Tubo per aspirazione esterna opzionale  
External suction hose optional



Visualizzazione immediata di tutte le informazioni  
The display shows immediately all available functions

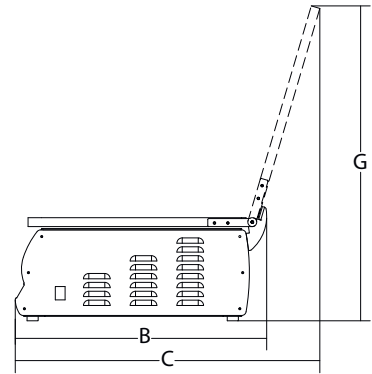
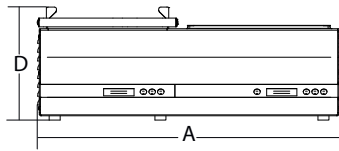
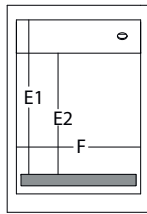

	watt	mc/h	mm	mm	mm	mm	lt	lt	mm	mm	mm	mm	mm	mm	mm	mm	kg	mm	kg
<b>Easysoft</b>	100/1.700	1ph	4	260	270x350 h.75	280x400 h.180	19.7	15	695	560	685	257	340	263	264	708	45	740x720x320	48





# SOFTCOOKER S

## Cottura a bassa temperatura *low temperature cooking*

Apparecchio per la cottura a bassa temperatura con riscaldamento statico dell'acqua.

- Struttura in acciaio inox, vasca di cottura gastronomica in acciaio inox.
- Pratiche maniglie per il trasporto della vasca.
- Potenti resistenze corazzate a contatto del fondo della vasca.
- Sistema elettronico di controllo della temperatura con visualizzazione della temperatura e del tempo di esercizio.
- Stesso sistema di controllo del Softcooker con  $\Delta T$  di 0,2°C:
- 5 programmi memorizzabili.
- Temperatura selezionabile in °C e °F.
- Coperchio vasca fornito di serie.
- Versione R con rubinetto per lo scarico dell'acqua.

*Low temperature cooking device with water static heating.*

- *Stainless steel structure and 1/1 GN made of stainless steel*
- *Practical handles to carry it easily*
- *Powerful shock-proof coated heating elements in contact with tank bottom*
- *Electronic control system of the temperature with working temperature display*
- *Same control system of Softcooker with  $\Delta T$  of 0,2°C:*
- *5 storable programs*
- *Temperature setting in °C and °F.*
- *Equipped with lid*
- *R versione with tap for discharging water.*



SOFTCOOKER S 1/1 GN



SOFTCOOKER S 2/3 GN



SOFTCOOKER S 2/3 GN



SOFTCOOKER S 1/1 GN



SOFTCOOKER SR 1/1 GN

SOFTCOOKER SR 2/3 GN

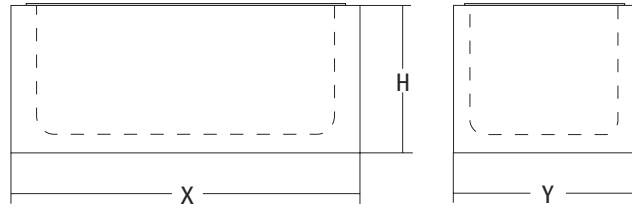

	watt	1ph	°C	lt	lt	mm	mm	mm	kg	mm	kg
<b>Softcooker S 1/1 GN</b>	1.700	1ph	24 ÷ 99	26.5	22	565	360	300	16	600x500x420	20
<b>Softcooker S 2/3 GN</b>	1.150	1ph	24 ÷ 99	16.5	14	390	360	300	5	600x500x420	9
<b>Softcooker SR 1/1 GN</b>	1.700	1ph	24 ÷ 99	29	25	575	370	300	16.5	600x500x420	20
<b>Softcooker SR 2/3 GN</b>	1.150	1ph	24 ÷ 99	19	17	400	370	300	5.5	600x500x420	9



SOFTCOOKER SR 2/3 GN



SOFTCOOKER SR 1/1 GN



# SOFTCOOKER SR WI-FOOD

cottura a bassa temperatura  
low temperature cooking



- Apparecchio per la cottura a bassa temperatura con riscaldamento statico dell'acqua.
- Struttura, vasca e coperchio in acciaio inox.
- Pratiche maniglie per il trasporto della vasca.
- Potenti resistenze corazzate a contatto nel fondo della vasca.
- Controllo touch Wi-Food con delta T di 0,2°C.
- Utilizzabile tramite APP gratuita, scaricabile sia per sistema Android che iOS.
- Pratica staffa di posizionamento per la scatola display permette, tramite sistema magnetico, di posizionare i comandi dove risultano più comodi e accessibili.
- 10 programmi memorizzabili sulla macchina e infiniti tramite APP.
- Temperatura selezionabile in °C e °F.
- Pratico rubinetto per lo scarico d'acqua.



SOFTCOOKER SR 2/3 WI-FOOD



SOFTCOOKER SR 1/1 WI-FOOD



- Low temperature cooking device with water static heating.
- Structure, tank and lid made of stainless steel.
- Practical handles to carry it easily
- Powerful armoured contact heating elements in the bottom of the tank.
- Wi-Food touch control with 0.2°C T delta.
- Can be used through a free app, downloadable for both the Android and iOS systems.
- The practical positioning bracket for the display box allows for placing the controls – by means of a magnetic system – in the most comfortable and accessible location.
- Up to 10 programmes storable on the machine and many more through the APP.
- Temperature settable in °C and in °F.
- Practical tap for discharging the water.



Comandi touch  
Touch controls.



Pratica staffa di posizionamento per la scatola display  
The practical positioning bracket for the display box

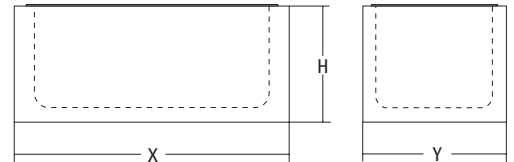

						X	Y	H			
	watt		°C	lt	lt	mm	mm	mm	kg	mm	kg
<b>Softcooker SR 2/3 Wi-Food</b>	2.000	1ph	24÷99.9 75.2÷199.9 F°	19	17	390	360	300	5.5	600x500x420	9.5
<b>Softcooker SR 1/1 Wi-Food</b>	2.000	1ph	24÷99.9 75.2÷199.9 F°	29	25	565	360	300	16.5	600x500x420	20.5



# SOFTCOOKER SR BI WI-FOOD

cottura a bassa temperatura  
low temperature cooking



SOFTCOOKER SR BI 2/3 WI-FOOD

- Apparecchio da incasso per la cottura a bassa temperatura con riscaldamento statico dell'acqua.
- Struttura, vasca e coperchio in acciaio inox.
- Potenti resistenze corazzate a contatto nel fondo della vasca.
- Controllo touch Wi-Food con delta T di 0,2°C.
- Utilizzabile tramite APP gratuita, scaricabile sia per sistema Android che iOS.
- Pratica staffa di posizionamento per la scatola display permette, tramite sistema magnetico, di posizionare i comandi dove risultano più comodi e accessibili.
- 10 programmi memorizzabili sulla macchina e infiniti tramite APP.
- Temperatura selezionabile in °C e °F.
- Spinotto ermetico IP 67 per eventuale rimozione del blocco comandi in operazioni di pulizia o tempi morti.
- Coperchio vasca con maniglia a scomparsa.
- Kit collegamento scarico acqua opzionale.

SOFTCOOKER SR BI 1/1 WI-FOOD

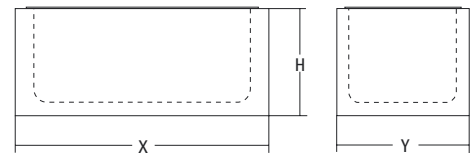

- Built-in device for cooking at low temperature with static heating of the water.
- Structure, tank and lid made of stainless steel.
- Powerful armoured contact heating elements in the bottom of the tank.
- Wi-Food touch control with 0.2°C T delta.
- Can be used through a free app, downloadable for both the Android and iOS systems.
- The practical positioning bracket for the display box allows for placing the controls – by means of a magnetic system – in the most comfortable and accessible location.
- Up to 10 programmes storable on the machine and many more through the APP.
- Temperature settable in °C and in °F.
- IP 67 hermetic connector for removing the control block during cleaning operations or idle periods.
- Tank lid with recessed handle.
- Optional water discharge device connection kit.

Spinotto ermetico IP 67  
IP 67 hermetic connectorPratica staffa di posizionamento per  
la scatola display  
The practical positioning bracket for  
the display boxKit collegamento scarico acqua  
opzionale  
Optional water discharge device  
connection kit.

	watt		°C	lt	lt	mm	mm	mm	mm	kg	mm	kg
Softcooker SR BI 2/3 Wi-Food	2.000	1ph	24÷99,9 75,2÷199,9 F°	19	17	350x320	400	370	300	5.5	600x500x420	9.5
Softcooker SR BI 1/1 Wi-Food	2.000	1ph	24÷99,9 75,2÷199,9 F°	29	25	520x320	575	370	300	16.5	600x500x420	20.5



# SOFTCOOKER WI-FOOD

cottura a bassa temperatura  
*low temperature cooking*

La rivoluzione nei sistemi di cottura a bassa temperatura è arrivata: il nuovo SOFTCOOKER Wi-Food di Sirman permette, tramite una APP gratuita, di accedere ad un mondo di ricette pronte, collaudate e di sicuro successo.

Si possono salvare e condividere ricette, si può pubblicizzare il proprio ristorante e attività, si possono salvare tutte le proprie esperienze e andarle a ritrovare con pochi click per ripeterle. Il tutto a bordo di una macchina potente, e flessibile, in grado di gestire fino a 80 Lt d'acqua, con un pratico ed immediato display touch dalla splendida visibilità.

### Vincitore del premio SMART LABEL a Host 2015

- Struttura in alluminio anodizzato.
- Ampio display touch 5", IP 67.
- Pratica maniglia per il trasporto.
- APP gratuita scaricabile da [www.softcooker.com](http://www.softcooker.com)
- L'APP permette di gestire più macchine in batteria.
- L'APP permette di gestire più livelli di cottura.

*The revolution in low temperature cooking has arrived! Sirman's new Wi-Food SOFTCOOKER lets you access a vast number of tried and tested recipes via a free app.*

*Recipes can be saved and shared, your restaurant or business can be advertised, and your comments recorded and recalled in just a few clicks. And all this comes from a powerful, flexible cooker capable of holding up to 80 litres of water, and with a practical, intuitive and high resolution touch-screen display.*

### Winner of the SMART LABEL award at Host 2015

- Anodized aluminium frame.
- Wide IP 67 touch display 5".
- Easy to handle holder.
- Free APP downloadable from [www.softcooker.com](http://www.softcooker.com)
- More units can be managed from the APP.
- Multiple cooking stages can be managed by the APP.



Vasca inox con coperchio 1/1 GN opzionale  
*Optional s/steel container with lid 1/1 GN*





Morsetto per fissaggio pentola  
Pot fixing clamp



Pratica maniglia per il trasporto  
Easy to handle holder

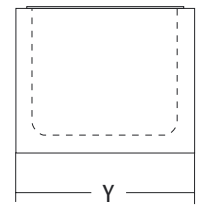
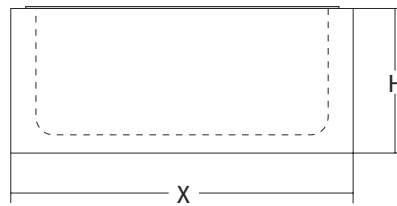
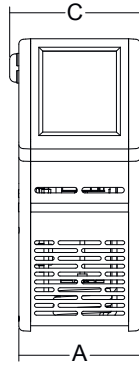
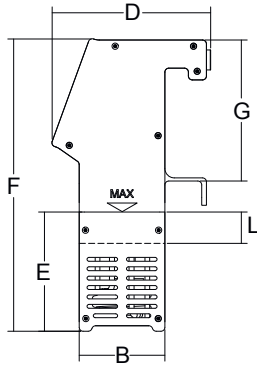

	watt	1ph	°C	lt	lt	mm	mm	mm	mm	mm	mm	mm	mm	mm	mm	kg	mm	kg
<b>Softcooker Wi-Food</b>	2.000	1ph	24-99,9 75,2-199,9 P	-	-	155	109	164	203	152	377	180	-	-	-	4.5	330x455x240	5.5
<b>1/1 GN</b>	-	-	-	27	22	-	-	-	-	-	-	-	565	360	230	7.7	720x500x350	11.5
<b>2/1 GN</b>	-	-	-	57.5	43	-	-	-	-	-	-	-	650	530	230	13	750x650x400	16

Vasca inox con coperchio 2/1 GN opzionale  
Optional s/steel container with lid 2/1 GN





# SOFTCOOKER Y09

Cottura a bassa temperatura  
*low temperature cooking*

- Riscaldatore termoregolato ad alta precisione.
- Visualizzatore di temperatura e tempo esercizio.
- 5 programmi memorizzabili
- Struttura in acciaio inox IP X3.
- Profondità di lavoro max 16,5 cm.
- Funzionamento ottimale fino a 80 lt.
- Dispositivo di protezione automatico in caso di utilizzo a secco.
- Ventola di circolazione per favorire una ottima miscelazione del prodotto.
- Dispositivo di blocco motore se rilevata sovratensione e sovratemperatura.

### Opzioni

- Vasca 1/1 GN inox con coperchio
- Vasca 2/1 GN inox con coperchio
- *High precision warmer with temperature control.*
- *Working temperature display.*
- *5 storable programs.*
- *IP X3 protection rated stainless steel structure.*
- *Can be applied to the pot by means of a clamp. (max depth 16,5 cm)*
- *Best performances up to 80 lt.*
- *Protection device switches off the warmer in case of accidental use outside the liquid.*
- *Circulating pump to help the best product mixing.*
- *Temperature sensor to prevent overload and overheating.*

### Optionals

- 1/1 GN s/steel container with lid
- 2/1 GN s/steel container with lid

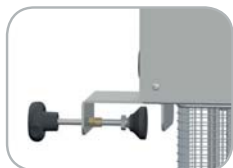
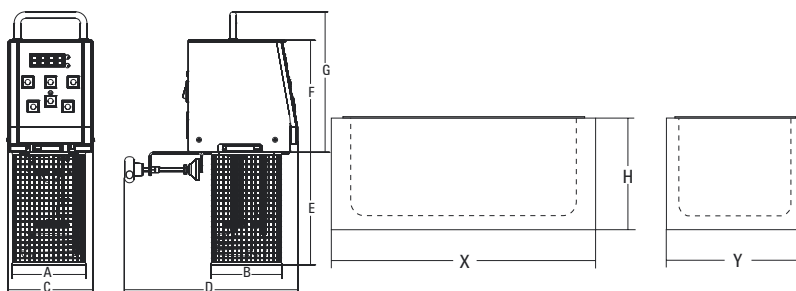

Morsetto per fissaggio pentola  
*Pot fixing clamp*

						A	B	C	D	E	F	G	X	Y	H			
	watt	1ph	°C	lt	lt	mm	mm	mm	mm	mm	mm	mm	mm	mm	mm	kg	mm	kg
<b>Softcooker Y09</b>	2.000	1ph	24÷99	-	-	110	105	130	260	170	170	210	-	-	-	4.5	330x455x240	5.5
<b>1/1 GN</b>	-	-	-	27	22	-	-	-	-	-	-	-	565	360	230	7.7	720x500x350	11.5
<b>2/1 GN</b>	-	-	-	57.5	43	-	-	-	-	-	-	-	650	530	230	13	750x650x400	16

Supporto vasche fino a 80 lt opzionale  
*Optional containers support until 80 lt*



2/1 GN

1/1 GN





# ALISEO

## forni a convezione convection ovens



- Struttura in acciaio inox interno ed esterno.
- Distanza tra ripiani cm 8
- Camera interna con angoli raggiati per una pulizia facile e veloce.
- Porta in acciaio inox, con doppio vetro.
- Illuminazione interna con due lampade.
- 4 griglie di serie facilmente rimovibili.
- Regolazione termostatica della temperatura.
- Timer di controllo cottura da 0' a 120' o continuo.

### ALISEO PLUS

- Umidificatore di serie.
- Sistema ventola potenziata per una migliore distribuzione della temperatura.

### ALISEO PLUS

- Umidificatore di serie.
- Sistema ventola potenziata per una migliore distribuzione della temperatura.

- *Stainless steel construction including chamber*
- *Distance between shelves cm 8.*
- *Seamless, round-cornered and easy to clean chamber to prevent contamination.*
- *Double glass stainless steel door.*
- *Effective 2 lamp chamber lighting.*
- *4 removable racks standard.*
- *Thermostatically controlled temperature.*
- *Choice of 0' to 120' programmable timer or continuous operation.*

### ALISEO PLUS

- *Humidifier.*
- *Inverter system allows for an even and effective heat distribution.*

### ALISEO PLUS

- *Humidifier.*
- *Inverter system allows for an even and effective heat distribution.*

ALISEO 4

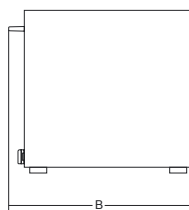
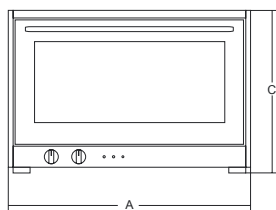

	watt		°C	lt	lt	mm	mm	mm	mm	kg	mm	kg
<b>Aliseo 2/3</b>	2.600	1ph	25+300	4	440x330	480x360 h.300	600	625	515	31	750x720x750	39.5
<b>Aliseo 2/3 Plus B</b>	3.200	1ph	25+300	4	2/3 gastro	480x420 h.340	620	708	590	37.5	750x720x750	46
<b>Aliseo 2/3 Grill</b>	2.600 grill 2.800 conv.	1ph	25+300	4	2/3 gastro	480x420 h.340	620	650	585	37	750x720x750	45
<b>Aliseo 4</b>	1ph 3.400 3ph 5.200	1ph/3ph	25+300	4	600x400 - 1/1 GN	650x460 h.360	820	760	610	54	800x1000x800	66
<b>Aliseo 4 Plus</b>	1ph 3.600 3ph 6.400	1ph/3ph	25+300	4	600x400 - 1/1 GN	650x460 h.360	820	760	610	54	800x1000x800	66



ALISEO 2/3



# BASIC - PRO

## Salamandre Salamandre

### SALAMANDRA BASIC

- Realizzate in acciaio inox.
- Simostato per la regolazione dell'intensità del calore.
- Griglia di cottura e griglia di protezione resistenze, in acciaio cromato.
- Cassetto raccogli briciole facilmente estraibile.
- Griglia di cottura posizionabile su quattro livelli in base alle esigenze di cottura del prodotto.
- Opzionale: Supporto a muro

### SALAMANDRA PRO 1/1 G

- Carcassa in acciaio inox.
- Corpo riscaldante regolabile in altezza.
- Cassetto raccogli briciole facilmente estraibile.
- Griglia di cottura in acciaio cromato.
- Resistenze corazzate.
- Camini di sfogo.
- Simostati elettronici.

### SALAMANDRA BASIC

- Made from stainless steel.
- Heating up controlled by a symostat.
- Galvanized steel gridiron and heating elements protection grill.
- Easy to remove crumb pan.
- Gridiron can be placed on 4 levels according to the cooking requirements.
- Optional wall mounted support

### SALAMANDRA PRO 1/1 G

- Stainless steel body.
- Height on the heating structure can be adjusted.
- Easy to remove crumb pan.
- Galvanized steel grill.
- Shock-proof coated heating elements.
- Vent outlets.
- Electronic symosthats.



SALAMANDRA PRO 1/1 G



Supporto a muro  
Wall support

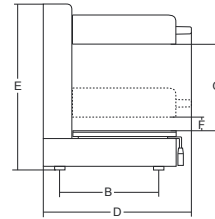
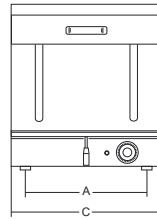
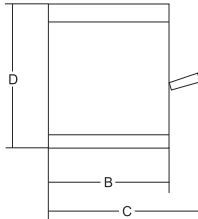
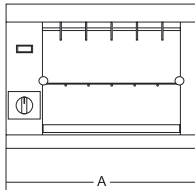

						<b>A</b>	<b>B</b>	<b>C</b>	<b>D</b>	<b>E</b>	<b>F</b>	<b>G</b>			
	watt		n.	mm	mm	mm	mm	mm	mm	mm	mm	mm	kg	mm	kg
<b>Salamandra Basic</b>	2.800	1ph	1	480x330 h.320	-	620	350	445	430	-	-	-	16	670x450x480	18
<b>Salamandra Pro 1/2 G</b>	1.700	1ph	1	-	385x350	330	400	400	545	510	30	240	45	500x630x650	50
<b>Salamandra Pro 1/1 G</b>	3.400	1ph	2	-	585x350	510	400	600	545	510	30	240	56	750x630x630	66



SALAMANDRA PRO 1/2 G



SALAMANDRA BASIC



# P.I. 2,5-3,5

## piastre induzione induction hobs



- Facilmente installabili in qualsiasi piano liscio presente in cucina, nei ristoranti e nelle sale da pranzo come dimostrazione, o la preparazione di piatti particolari di fronte ai clienti, grazie all'assenza di fumi e odori.
- Dotate di pulsantiera digitale graduata.
- Estremamente facili da utilizzare e da pulire.
- Superficie di cottura liscia, pratica da pulire.
- Massima sicurezza grazie alla superficie di cottura che non si riscalda.
- Risparmio energetico grazie alla velocità di riscaldamento e all'elevata resa.
- Non sono previsti tempi di pre-riscaldamento ed il consumo di energia si blocca non appena la pentola viene rimossa dal piano.
- *The induction hobs are easy to install on every working surface in kitchens, restaurants or dining rooms; thanks to the absence of fumes they are perfect for public cooking performances or when the preparation is made in view of customers.*
- *Graduated digital controls.*
- *Extremely easy to use and to clean.*
- *Smooth cooking surface makes cleaning easy.*
- *Safe operations are ensured by the cooking surface which is never heating up.*
- *Induction hobs are energy saving thanks to heating efficiency and no need to heat up.*
- *Electric absorption is stopped when the pan is removed from the hob surface.*

P.I. 3,5 KW



Piastre modulari  
Modular grills

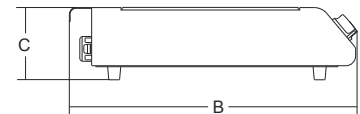
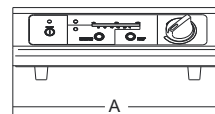

	watt	1ph	mm	mm	mm	mm	mm	kg	mm	kg
P.I. 2,5	2.500	1ph	322x270	-	320	440	115	7.5	500x370x180	9
P.I. 2,5 BI	2.500	1ph	322x270	307x470	320	500	115	9	500x370x180	10.5
P.I. 3,5 kw	3.500	1ph	330x275	-	340	460	135	11	510x380x200	12.5



P.I. 2,5 BI



P.I. 25



P. 240

## SNACK E PIZZA

Studiata appositamente per soddisfare le esigenze dei professionisti della piccola ristorazione – pub, bar, piccoli ristoranti, ecc... - la 'linea snack' firmata Sirman propone tostiere, piastre, girawurstel, mixer e molti altri strumenti che si impongono nel mercato per l'estrema praticità d'uso, l'assoluta attenzione riservata ai criteri igienici e la facilità di pulizia.

A tali grandi vantaggi, si deve aggiungere il raffinato design che contraddistingue tutti i prodotti della linea snack e, soprattutto, la particolare attenzione rivolta alla riduzione del consumo energetico.

## SNACK AND PIZZA

*Studied specifically to meet the professional's needs in small restaurants, pubs, bars, etc., Sirman's "Snack range" includes toasters, hot plates, frankfurter spits, mixers and many other kitchen tools that have become popular on the market because they are so practical to use, designed with a great attention to hygienic aspects and easy to clean. These great advantages go hand in hand not only with an elegant design that distinguishes all the products in the Snack range but also, and equally important, with a particular attention to reducing energy consumption.*





# ELIO

## piastre sandwich grills

- Facile da maneggiare e da posizionare, grazie alle sue piccole dimensioni, offre in poco spazio una ottimale superficie di lavoro.
  - Disponibile con piastre sia lisce che rigate
  - Struttura in acciaio inox.
  - Piastre in ghisa con trattamento di vetroceramicatura:
    - massima robustezza e durata
    - ottima conducibilità termica
    - estrema facilità di pulizia
  - Piastre superiori con durezza regolabile ad esigenza dell'operatore.
  - Piastra superiore autobilanciata.
  - Resistenze corazzate aderenti alle piastre per una ottimale conducibilità termica.
  - Termostato regolabile fino a 300 °C.
  - Timer meccanico opzionale.
- 
- *Thanks to its small size, it is easy to handle and to position, offering as well a large cooking surface.*
  - *Ribbed and smooth surfaces available.*
  - *Structure in stainless steel.*
  - *Cast iron plates with ceramic coating treatment:*
    - *highest sturdiness and life time;*
    - *perfect thermal conductivity;*
    - *very easy to clean.*
  - *Adjustable upper plates.*
  - *Self balancing upper plate.*
  - *Shock-proof coated heating elements, adherent to the plates for a perfect thermal conductivity.*
  - *Adjustable thermostat up to 300° C.*
  - *Mechanical timer available.*



ELIO RR

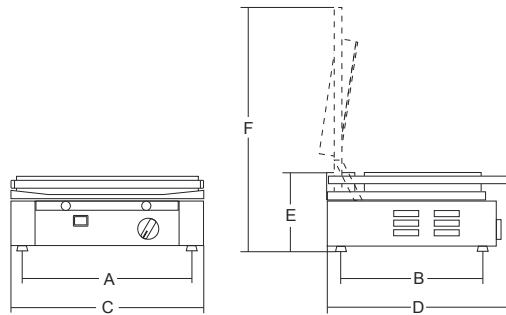

	watt	1ph	mm	mm	mm	mm	mm	mm	mm	kg	mm	kg
ELIO	1.550	1ph	250x255	215	275	260	435	235	500	16	490x320x330	17



ELIO LR TIMER



Legenda modelli  
Models key



# CORT

## piastre sandwich grills



- Facile da maneggiare e da posizionare, grazie alle sue piccole dimensioni, offre in poco spazio una ottimale superficie di lavoro.
- Disponibile con piastre sia lisce che rigate
- Struttura in acciaio inox.
- Piastre in ghisa con trattamento di vetroceramicatura:
  - massima robustezza e durata
  - ottima conducibilità termica
  - estrema facilità di pulizia
- Piastre superiori con durezza regolabile ad esigenza dell'operatore.
- Piastra superiore autobilanciata.
- Resistenze corazzate aderenti alle piastre per una ottimale conducibilità termica.
- Termostato regolabile fino a 300 °C.
- Timer meccanico opzionale.
- Solo i modelli PS hanno le piastre smontabili per la pulizia.

- *Thanks to its small size, it is easy to handle and to position, offering as well a large cooking surface.*
- *Ribbed and smooth surfaces available.*
- *Structure in stainless steel.*
- *Cast iron plates with ceramic coating treatment:*
  - *highest sturdiness and life time;*
  - *perfect thermal conductivity;*
  - *very easy to clean.*
- *Adjustable upper plates.*
- *Self balancing upper plate.*
- *Shock-proof coated heating elements, adherent to the plates for a perfect thermal conductivity.*
- *Adjustable thermostat up to 300° C.*
- *Mechanical timer available.*
- *Only PS models: cast iron plates removable for cleaning.*

CORT LR TIMER

CORT RR PS TIMER

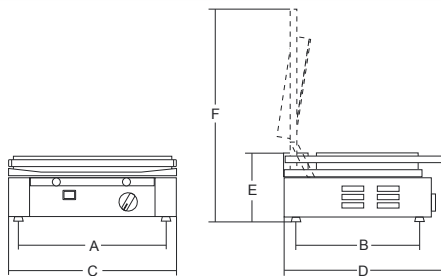

	watt	1ph	mm	mm	mm	mm	mm	mm	mm	kg	mm	kg
<b>Cort</b>	2.100	1ph	355x255	340	275	380	435	235	500	22	430x420x270	23
<b>Cort PS</b>	2.100	1ph	355x255	340	275	380	420	155	540	22	430x420x270	23



CORT RR PS TIMER



CORT RR



CORT XX TIMER



# PD

## piastre sandwich grills

[www.paninigrill.com](http://www.paninigrill.com)

- Piastre resistenti nel tempo create in ghisa trattata con smalto alimentare vetrificato, per garantire igienicità e inattaccabilità da acidi e sali oltre ad una assoluta resistenza all'ossidazione.
- Disponibile con piastre in ghisa lisce, rigate o miste o con piastre inox lisce.
- Struttura in acciaio inox.
- Piastre in ghisa con trattamento di vetroceramicatura:
  - Massima robustezza e durata.
  - Ottima conducibilità termica.
  - Estrema facilità di pulizia.
- Piastre superiori autobilanciate con durezza regolabile ad esigenza dell'operatore
- Resistenze corazzate aderenti alle piastre per una ottimale conducibilità termica.
- Due termostati regolabili fino a 300 °C permettono di gestire separatamente le due metà della piastra.
- Ideali per grossi carichi di lavoro e uso continuo.
- Timer meccanico opzionale.
- Solo i modelli PS hanno le piastre smontabili per la pulizia.
- *Long life cast iron plates, which ensure hygiene, acid and salt proofness and resistance to oxidation.*
- *Ribbed, smooth or mixed ribbed/smooth cast iron or smooth stainless steel surfaces available.*
- *Structure in stainless steel.*
- *Cast iron plates with ceramic coating treatment:*
  - *Highest sturdiness and life time.*
  - *Perfect thermal conductivity.*
  - *Very easy to clean.*
- *Self balancing adjustable upper plates*
- *Shock-proof coated heating elements, adherent to the plates for a perfect thermal conductivity.*
- *Two adjustable thermostats up to 300° C, which enable to use the plates sepa-rately.*
- *Heavy-duty machine.*
- *Mechanical timer available.*
- *Only PS models: cast iron plates removable for cleaning.*



PD LL-RR TIMER



PD RR-RR PS



Legenda modelli  
Models key

				A	B	C	D	E	F			
	watt		mm	mm	mm	mm	mm	mm	mm	kg	mm	kg
PD	3.000	1ph	500x255	475	275	515	435	235	500	28	560x430x270	30
PD PS	3.000	1ph	500x255	475	275	526	435	235	540	28	560x430x270	30
PDC	3.000	1ph	500x255	475	275	515	435	235	500	26	560x430x270	27
PD Wafer	3.000	1ph	ø 170	475	275	515	435	235	500	34	560x430x270	36



PD LR-RR



PDC RR-R



PD RR-RR TIMER



PD XX TIMER



PDW





# PD POWER

## piastre sandwich grills



- Piastra superiore autobilanciata.
- Resistenze corazzate aderenti alle piastre per una ottimale conducibilità termica.
- Termostato regolabile fino a 300 °C.
- Ideali per grossi carichi di lavoro e uso continuo.
- Protezione termica sulle 4 resistenze.
- 2 timer di serie.
- Piedini rialzati per facilitare la pulizia anche sotto la piastra.
- Vaschetta capiente raccogli briciole.
- Coperchio molle con maniglia facilmente estraibile.
- Distanziali laterali di serie.

- *Self balancing upper plate.*
- *Shock-proof coated heating elements, adherent to the plates for a perfect thermal conductivity.*
- *Adjustable thermostat up to 300° C.*
- *Heavy-duty machine.*
- *Thermally protected heating elements.*
- *Comes with 2 timers.*
- *Higher legs to keep your counter under the unit clean.*
- *Detachable front drip tray.*
- *Removable hinges cover.*
- *Comes with side spacers.*

PD POWER RR-RR TIMER

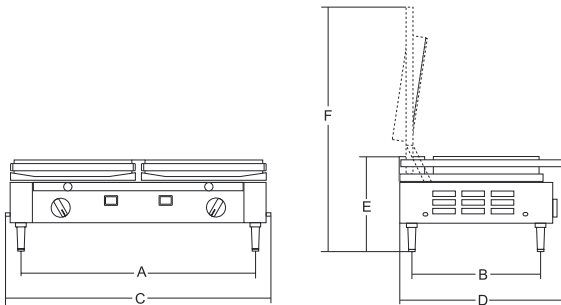

				A	B	C	D	E	F			
	watt	3ph	mm	mm	mm	mm	mm	mm	mm	kg	mm	kg
PD Power	4.500	3ph	500x255	475	275	545	435	300	660	33	560x540x300	35



PD POWER RL-RR TIMER



PD POWER LL-RR TIMER



Legenda modelli  
Models key



# TOP

## piastre sandwich grills

- Piastre resistenti nel tempo create in ghisa trattata con smalto alimentare vetrificato, per garantire igienicità e inattaccabilità da acidi e sali oltre ad una assoluta resistenza all'ossidazione.
- Disponibile con piastre in ghisa lisce, rigate o miste o con piastre inox lisce.
- Struttura in acciaio inox.
- Piastre in ghisa con trattamento di vetroceramicatura:
  - Massima robustezza e durata.
  - Ottima conducibilità termica.
  - Estrema facilità di pulizia.
- Resistenze corazzate aderenti alle piastre per una ottimale conducibilità termica e rapido riscaldamento.
- Due termostati regolabili fino a 300° C permettono di gestire separatamente le due metà della piastra.
- Ideali per grossi carichi di lavoro e uso continuo.
- Timer meccanico opzionale.

- *Long life cast iron plates, which ensure hygiene, acid and salt proofness and resistance to oxidation.*
- *Ribbed, smooth or mixed ribbed/smooth cast iron or smooth stainless steel surfaces available.*
- *Structure in stainless steel.*
- *Cast iron plates with ceramic coating treatment:*
  - *Highest sturdiness and life time.*
  - *Perfect thermal conductivity.*
  - *Very easy to clean.*
- *Shock-proof coated heating elements, adherent to the plates for a perfect thermal conductivity.*
- *Two adjustable thermostats up to 300° C, which enable to use the plates sepa-rately.*
- *Heavy-duty machine.*
- *Mechanical timer available.*



TOP R TIMER



Legenda modelli  
Models key

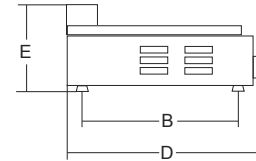
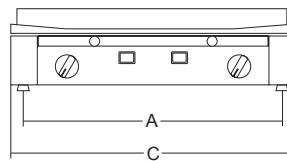

	watt	ph	mm	mm	mm	mm	mm	mm	kg	mm	kg
Top	1.800	1ph	500x255	475	275	515	435	170	18	560x430x270	20



TOP L TIMER



TOP X TIMER



# CREPES 1

## crepiera crêpe

- Struttura in acciaio inox.
- Forma semplice e compatta.
- Nessun ingombro oltre alla superficie di lavoro.
- Piano di cottura in ghisa cromata per una distribuzione termica ottimale.
- Controllo a mezzo simostato.
- Resistenze corazzate.
- Piedini regolabili in altezza per una sicura e stabile collocazione.
- Disponibile sia con piano liscio che con bordo rialzato.

- *Structure in stainless steel.*
- *Simple and compact shape.*
- *Overall dimensions is the work surface.*
- *Chromium-coated cast iron cooking surface for a perfect thermal distribution.*
- *Symosthal control.*
- *Shock-proof coated heating elements.*
- *Adjustable feet for a safe and steady placing.*
- *With smooth surface or with mould available.*



CREPES 1

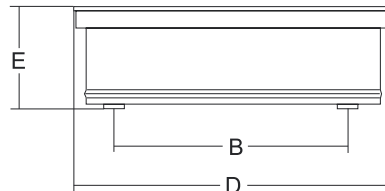
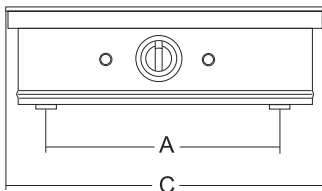

	watt		mm	mm	mm	mm	mm	mm	kg	mm	kg
Crepes 1 / 1B	2.000	1ph	350	200	200	350	350	135	9,5	410x430x220	10,5



CREPES 1B



# CORT V - PD V - PD V TOP

piastre vetroceramica  
ceramic glass  
sandwich grills

- Struttura in acciaio inox.
  - Piani di cottura in vetroceramica Ceran®.
  - Controllo a mezzo termostato.
  - Piano di cottura raccordato al corpo macchina facile da pulire.
  - Pratico cassetto raccogli liquidi e residui di cottura.
  - Piastre superiori autobilancianti e regolabili a piacere dell'operatore.
  - Piedini regolabili in altezza per un maggior adeguamento piano di lavoro.
  - Ideali quando la messa in temperatura da freddo diventa prioritaria.
- Structure in stainless steel.
  - Ceran® ceramic-glass cooking surfaces.
  - Thermostat control.
  - Easy to clean.
  - Useful drip tray for liquids and other cooking leavings.
  - Self balancing adjustable upper plates.
  - Adjustable feet for a safe and steady placing.
  - Ideal for a fast achievement of working temperature.



PD V LL-LL

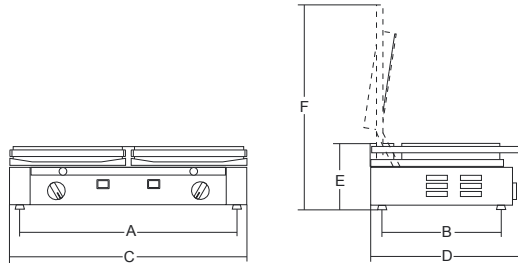

	watt		mm	mm	mm	mm	mm	mm	mm	kg	mm	kg
<b>Cort V</b>	3.000	1ph	340x290	375	340	435	490	170	550	14	430x560x270	16
<b>Cort V Top</b>	1.500	1ph	340x290	375	340	435	455	170	-	6.5	430x560x270	8.5
<b>PD V</b>	3.000	1ph	260x290 x2	645	365	700	490	170	550	22	760x560x280	24.5
<b>PD V Top</b>	1.500	1ph	260x290x2	645	365	700	490	170	-	9	760x560x280	11



CORT V TOP

CORT V LL

CORT V LR

CORT V RR

PD V TOP



## PD VC

piastre vetroceramica  
ceramic glass  
sandwich grills



PD VC RR-RR

- Struttura in acciaio inox.
- Piani di cottura in vetroceramica Ceran®.
- Controllo a mezzo termostato.
- Piano di cottura raccordato al corpo macchina facile da pulire.
- Pratico cassetto raccogli liquidi e residui di cottura.
- Piastre superiori autobilancianti e regolabili a piacere dell'operatore.
- Piedini regolabili in altezza per un maggior adeguamento piano di lavoro.
- Ideali quando la messa in temperatura da freddo diventa prioritaria.

- Structure in stainless steel.
- Ceran® ceramic-glass cooking surfaces.
- Thermostat control.
- Easy to clean.
- Useful drip tray for liquids and other cooking leavings.
- Self balancing adjustable upper plates.
- Adjustable feet for a safe and steady placing.
- Ideal for a fast achievement of working temperature.

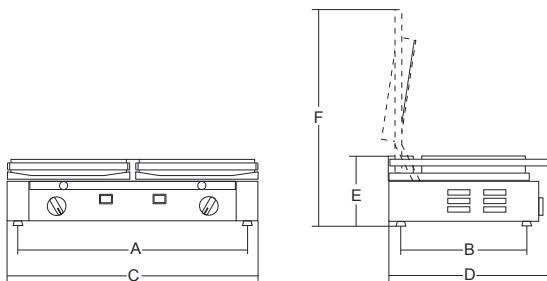

Cassetto raccolta liquidi e residui di cottura  
Useful drip tray for liquids and other cooking leavings.

	watt	ph	mm	mm	mm	mm	mm	mm	mm	kg	mm	kg
PD VC	3.200	1ph	530x255	542	330	592	441	166	565	30	760x560x280	33



PD VC LL-RR



# 4Q - 6Q - 12Q

## tostiere

### sandwich toasters

- Ideali per riscaldare pizze, panini e cibi precotti; cucinare hamburger, würstel, toast farciti e piadine.
- Costruite interamente in acciaio inox.
- Griglie facilmente smontabili per la pulizia.
- Cassetto raccoglibriciole asportabile.
- Pinze in acciaio cromato in dotazione.
- Disponibili sia con resistenze e tubi al quarzo che con resistenze corazzate.
- Timer da 1 a 15 minuti.

#### Opzionali:

- deviatore per esclusione resistenza inferiore
- 2. Pinza lunga / 3. griglia intera / 4. griglia doppia
- *Ideal for heating up pizzas, sandwiches and ready-cooked foods, for cooking hamburgers, wurstels and rolls.*
- *Stainless steel construction.*
- *Easy to clean grills.*
- *Removable drip tray.*
- *Chromium-plated steel pincers.*
- *Elements with quartz tubes or shock-proof coated heating elements available.*
- *15 minutes timer.*

#### Options:

- selector to switch off the lower heating elements
- 2. Extra long sandwich tongs / 3. Full-size grate / 4. Double grate



4Q  
1. pinze di serie  
1. Standard tongs

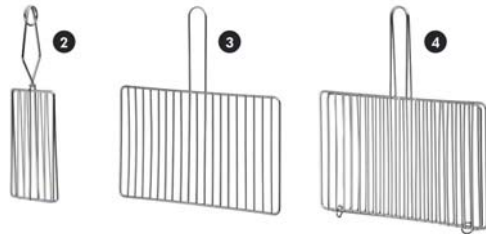
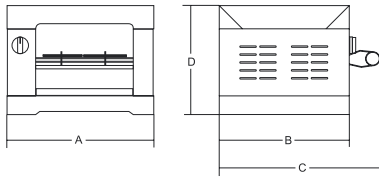

							A	B	C	D			
	watt	n.					mm	mm	mm	mm	kg	mm	kg
4Q	1.600	1ph	4	yes	no	235x240	360	265	410	240	6	550x320x300	7
6Q	2.400	1ph	6	yes	no	355x240	475	265	410	240	7.5	550x320x300	8.5
6Q P	2.800	1ph	6	yes	no	355x240	475	265	410	240	7.5	550x320x300	8.5
6C	2.900	1ph	6	no	yes	355x240	475	265	410	240	7.5	550x320x300	8.5
12Q	3.000	1ph	12	yes	no	355x240	475	265	410	365	9	570x320x420	11
12Q P	3.600	1ph	12	yes	no	355x240	475	265	410	365	9	570x320x420	11
12C	4.350	1ph	12	no	yes	355x240	475	265	410	365	9	570x320x420	11



12Q



6Q

Resistenze corazzate  
Shock-proof, coated heating elements





# TOSTONE

tostiere









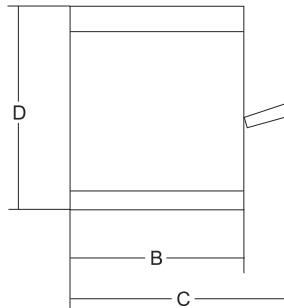
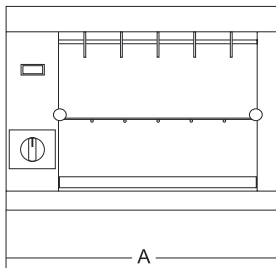



sandwich toasters



- Costruito interamente in acciaio inox.
- Griglie facilmente smontabili per la pulizia.
- Cassetto raccoglibriciole asportabile.
- In dotazione 2 griglie in acciaio cromato.
- Tubi al quarzo efficienti e veloci
- Ideale per riscaldare pizze, panini e cibi precotti; cuocere bruschette, hamburger, würstel, toast farciti e piadine, come pure gamberoni, sardine, verdure e qualsiasi prodotto che necessiti di una veloce e marcata grigliatura.

- Entirely built out of stainless steel.
- Easy to clean grills.
- Removable drip tray.
- 2 grills in chrome steel are included.
- Fast and efficient quartz heaters.
- Perfect to heat up pizza, sandwiches and pre-cooked foodstuffs; to toast bruschetta bread, hamburgers, hot dogs, stuffed toasts and piadina bread, and also king shrimps, sardines, vegetables and any product you need to toast fast and with marked grill lines.



												
	watt	ph	n.	mm	mm	mm	mm	mm	mm	kg	mm	kg
<b>Tostone</b>	3.600	1ph	3	400x350 h.290	400x330 x2	525	380	392	365	12	670x450x480	16



# TOSTÌ

## roller toast conveyor toasters

- Costruito interamente in acciaio inox AISI 304.
- Tappeto per la tostatura in acciaio AISI 304.
- Motore auto-ventilato.
- Ventilatore tangenziale per raffreddare il mantello esterno per evitare le scottature.
- Resistenze corazzate per una lunga durata.
- Riflettente su resistenze per una maggiore resa.
- Possibilità di selezionare il funzionamento delle resistenze.
- Scivoli di carico e scarico prodotto.
- Chiusura posteriore ribaltabile per consentire lo scarico frontale o posteriore.
- Motore con velocità variabile.

### Opzione

- Protezione comandi opzionale

- *AISI 304 stainless steel construction.*
- *AISI 304 stainless steel conveyor.*
- *Fan-cooled motor.*
- *Built-in cooling-fan to prevent overheating and burns.*
- *Reinforced heating elements against burnout and breakage.*
- *Reflecting heating elements for upper and lower heat ensure that the product is quickly and evenly heated.*
- *Upper and lower elements can be selected for perfect golden toasting every time.*
- *Easy-to-load rack with rear or front discharge.*
- *Easy-to-load rack with rear or front discharge.*
- *Variable speed motor.*

### Optional

- *Optional controls protection*



TOSTÌ 18 VV

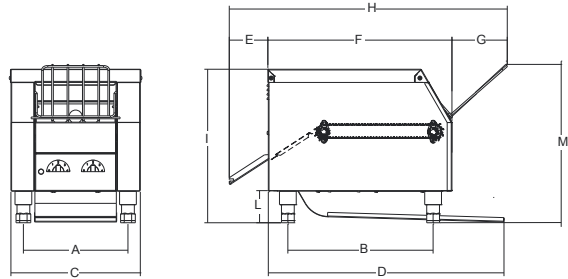

	watt	n.	mm	mm	mm	mm	mm	mm	mm	mm	mm	mm	mm	mm	kg	mm	kg	
<b>Tosti 18 VV</b>	1.300	1ph	min. 65 max 360	185x500	238	330	294	535	88	418	126	632	349	73	360	12	670x450x480	14



Protezione comandi opzionale  
*Optional controls protection*





# ROLLER

## roller toast conveyor toasters



- Facili e pratici da usare sono adatti per tostare e riscaldare crostini, bruschette, pizzette, patate, brioche e stuzzichini vari.
- Costruiti interamente in acciaio inox AISI 304 e tappeto per la tostatura in acciaio AISI 304.
- Camera di cottura con isolamento termico.
- Motore auto-ventilato.
- Vano comandi con ventola di raffreddamento per i componenti elettrici.
- Tubi al quarzo, con funzionamento modulare.
- Variatore di velocità nelle versioni VV.
- Scivoli di carico e scarico prodotto.
- Cassetto di raccolta briciole facilmente estraibile.
- Chiusura posteriore ribaltabile per consentire lo scarico frontale o posteriore del prodotto (no per il Roller Breakfast).

- *Easy to use and suitable for toasting or heating up bread, bruschetta, pizza, croissants, french fries and many other snacks.*
- *Made from AISI 304 S/S with AISI 304 S/S conveyor belt.*
- *Thermal insulation of the chamber.*
- *Fan-cooled motor.*
- *Fan cooled controls compartment.*
- *The heating elements covered by quartz tubes can be switched on independently.*
- *Variable speed drive. (VV versions)*
- *Easy-to-load rack with rear or front discharge.*
- *Easy to remove crumb pan.*
- *Tilting back closing plate allows rear delivery of the product (not on Roller Breakfast).*

**ROLLER BRUSCHETTA VV**

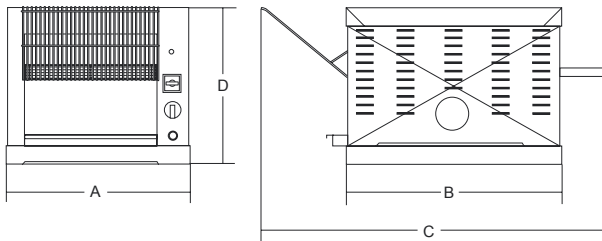

					<b>A</b>	<b>B</b>	<b>C</b>	<b>D</b>			
	watt	1ph	n.	mm	mm	mm	mm	mm	kg	mm	kg
<b>Roller Breakfast</b>	2.660	1ph	200	220x330	370	480	630	340	16	450x660x440	18.5
<b>Roller Breakfast VV</b>	2.660	1ph	80 + 360	220x330	370	480	630	340	16	450x660x440	18.5
<b>Roller Long</b>	3.000	1ph	410	305x410	430	530	870	360	22	720x540x480	27
<b>Roller Long VV</b>	3.000	1ph	n.132 ÷ 420 toast 9x9 cm n.165 ÷ 525 toast 8x8 cm	305x410	430	530	870	360	22	720x540x480	27.5
<b>Roller Bruschetta VV</b>	3.000	1ph	75 + 230	305x410 (x2)	450	535	1270	560	27	860x550x500	29



**ROLLER BREAKFAST**



**ROLLER LONG VV**



# VISTA

## vetrinette brioche pastry display cabinets

- Vetrinette per l'esposizione ed il mantenimento di alimenti come brioche, dolci e stuzzichini.
- Disponibile in 1 o 2 piani.
- Piani d'appoggio estraibili in acciaio inox.
- Basamento in alluminio perfettamente liscio per una facile pulizia.
- Struttura in plexiglas trasparente e profili di alluminio anodizzato.
- 2 porte apribili verticalmente.

### VISTA BRIOCHE

- Versione calda con termostato regolabile.
- Riscaldamento a bassa temperatura per evitare di seccare il prodotto.

### VISTA HOT

- Versione calda con regolazione fino a 70° C.
- Vaschetta d'acqua per il mantenimento dell'umidità.



- Case for displaying and storing croissants, cakes and other snacks.
- Available with 1 or 2 levels.
- S/S extractable product holding surfaces.
- Aluminium, perfectly smooth base easy to clean.
- Transparent plexiglas structure and anodised aluminium profiles.
- 2 vertically openable doors.

### VISTA BRIOCHE

- Hot version with adjustable thermostat.
- Heating at low temperatures to avoid drying the product.

### VISTA HOT

- Hot version with adjustable thermostat up to 70° C.
- Water tank to maintain humidity.

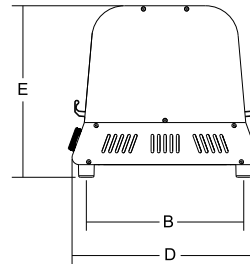
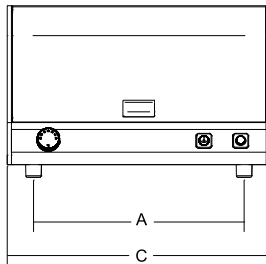

						A	B	C	D	E			
	watt		°C	mm	mm	mm	mm	mm	mm	mm	kg	mm	kg
Vista P1N	-	-	-	480x290	-	400	300	500	355	325	7	620x430x350	11
Vista P1 Brioche	300	1ph	max 40	480x290	-	400	300	500	355	325	8	620x430x350	12
Vista P1 Hot	450	1ph	max 70	480x290	-	400	300	500	355	325	8	620x430x350	12
Vista P2N	-	-	-	480x290	480x265	400	300	500	355	405	9	620x430x450	13
Vista P2 Brioche	300	1ph	max 40	480x290	480x265	400	300	500	355	405	10	620x430x450	14
Vista P2 Hot	450	1ph	max 70	480x290	480x265	400	300	500	355	405	10	620x430x450	14



VISTA P1 BRIOCHES



VISTA P1N



VISTA P2N



# VISTA BOLD

## vetrinette brioche pastry display cabinets

- Vetrinette per l'esposizione ed il mantenimento di alimenti come brioche, dolci e stuzzichini
- Piani d'appoggio estraibili in acciaio inox
- Struttura in plexiglas trasparente e profili di alluminio anodizzato
- 2 porte apribili verticalmente.

### Opzioni:

- Led di illuminazione da 20 watt per i modelli a 3 piani d'appoggio (esclusi tutti i modelli Hot).

### VISTA BOLD BRIOCHE

- Versione calda con termostato regolabile.
- Riscaldamento a bassa temperatura per evitare di seccare il prodotto

### VISTA BOLD HOT

- Versione calda con regolazione fino a 70° C.
- Vaschetta d'acqua per il mantenimento dell'umidità.

- *Case for displaying and storing croissants, cakes and other snacks.*
- *S/S extractable product holding surfaces.*
- *Transparent plexiglas structure and anodised aluminium profiles.*
- *2 vertically openable doors .*

### Options:

- *Optional lighting LED, 20 watt for models with 3 levels (not for Hot versions).*

### VISTA BOLD BRIOCHE

- *Hot version with adjustable thermostat.*
- *Heating at low temperatures to avoid drying the product.*

### VISTA BOLD HOT

- *Hot version with adjustable thermostat up to 70° C.*
- *Water tank to maintain humidity.*



VISTA P2 BOLD

VISTA P3 BOLD



VISTA P3 BOLD BRIOCHE

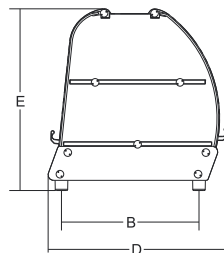
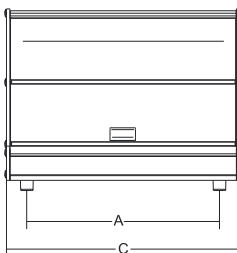

							A	B	C	D	E			
	watt		°C	mm	mm	mm	mm	mm	mm	mm	mm	kg	mm	kg
Vista P2 Bold	-	-	-	530x356	530x320	-	450	325	550	405	425	13	660x500x470	17
Vista P2 Bold Brioche	300	1ph	max 40	530x356	530x320	-	450	325	550	405	425	15	660x500x470	19
Vista P2 Bold Hot	450	1ph	max 70	530x356	530x320	-	450	325	550	405	425	15	660x500x470	19
Vista P3 Bold	-	-	-	530x356	530x350	530x300	450	325	550	405	565	14	660x500x610	18
Vista P3 Bold Brioche	300	1ph	max 40	530x356	530x350	530x300	450	325	550	405	565	16	660x500x610	20
Vista P3 Bold Hot	450	1ph	max 70	530x356	530x350	530x300	450	325	550	405	565	16	660x500x610	20



# VISTA TOWER

## vetrinette brioche pastry display cabinets

- Vetrinette per l'esposizione ed il mantenimento di alimenti come brioche, dolci e stuzzichini
- Piani d'appoggio estraibili in acciaio inox
- Struttura in plexiglas trasparente e profili di alluminio anodizzato

**Opzioni:**

- Led di illuminazione da 20 watt, escluso il modello Hot.

**VISTA TOWER HOT**

- Versione calda con regolazione fino a 70° C.
- Vaschetta d'acqua per il mantenimento dell'umidità.
- *Case for displaying and storing croissants, cakes and other snacks.*
- *S/S extractable product holding surfaces.*
- *Transparent plexiglas structure and anodised aluminium profiles.*

**Optionals:**

- *Optional lighting LED, 20 watt (not for Hot version).*

**VISTA TOWER HOT**

- *Hot version with adjustable thermostat up to 70° C.*
- *Water tank to maintain humidity.*



VISTA TOWER HOT

VISTA TOWER

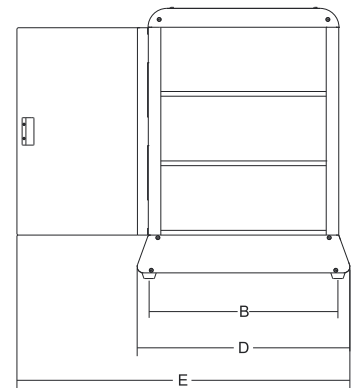
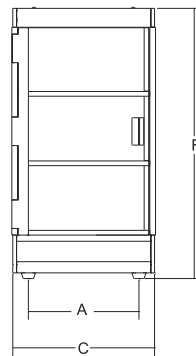

	watt		°C	mm	mm	mm	mm	mm	mm	mm	mm	mm	kg	mm	kg
<b>Vista Tower</b>	-	-	-	280x380	280x380	280x380	234	400	300	450	705	570	13	380x510x625	15
<b>Vista Tower Hot</b>	450	1ph	max 70	280x380	280x380	280x380	234	400	300	450	705	570	14	380x510x625	16

# CUBE

## vetrinette brioche pastry display cabinets

- Vetrinette per l'esposizione ed il mantenimento di alimenti come brioche, dolci e stuzzichini.
- Struttura in plexiglass trasparente e colonne in alluminio estruso anodizzato.
- Piani d'appoggio estraibili in acciaio inox AISI 304.
- 2 porte apribili verticalmente con maniglie in alluminio estruso anodizzato.

### CUBE HOT

- Termostato regolabile.
- Vaschetta per l'acqua ideale per il mantenimento dell'umidità.
- Riscaldamento a bassa temperatura per evitare che il prodotto si secchi.
- Protezione inferiore in acciaio inox AISI 304.

- Case for displaying and storing croissants, cakes and other snacks.
- Structure in transparent plexiglass and columns in anodised extruded aluminium.
- Extractable shelves in AISI 304 stainless steel.
- 2 vertically openable doors with handles in anodised extruded aluminium.

### CUBE HOT









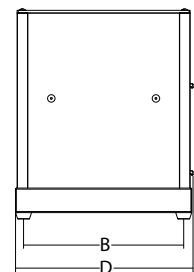
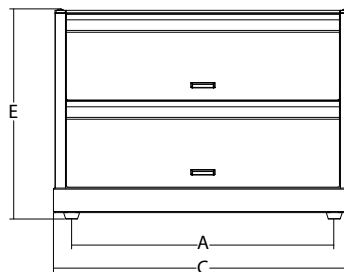



- Adjustable thermostat.
- Small water tank, perfect for maintaining humidity.
- Low temperature heating to avoid drying the products.
- AISI 304 stainless steel bottom protection.

CUBE P2 HOT



CUBE P2 N



													
	watt		°C	mm	mm	mm	mm	mm	mm	mm	kg	mm	kg
Cube P2 N	-	-	-	512x295	512x295	492	300	560	332	395	9,6	660x500x610	13
Cube P2 Hot	450	1ph	max 70	512x295	512x295	492	300	560	347	395	11,8	660x500x610	16





# NIGHT & DAY

vetrinetta e piastra buffet  
display cabinet and buffet plate



VISTA NIGHT & DAY

- Vetrinetta e piastra da buffet sia calda che fredda.
- Grande praticità e versatilità con ingombro minimo.
- Piano di appoggio in alluminio anodizzato.
- Corpo in acciaio inox.
- Invertitore caldo-off-freddo.
- Pratico termometro digitale di controllo.
- Sistema raffreddante/riscaldante con modulo termoelettrico a basso consumo (70Watt).
- Può essere affiancata in modo continuo.
- Piedini regolabili.

- *Hot and cold plate for buffet.*
- *Easy and practical to use with minimum overall dimensions.*
- *Anodized aluminium holding surface.*
- *Stainless steel body.*
- *Hot - off - cold switch positions.*
- *Digital thermometer for temperature control.*
- *Heating and cooling system based on energy saving thermo-electric module. (70 watt)*
- *The plates can be placed side by side.*
- *Adjustable feet.*

Vista Night & Day

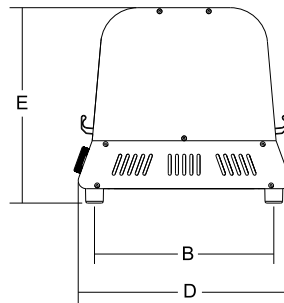
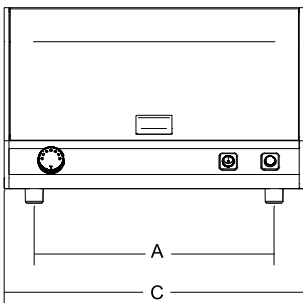

Night & Day

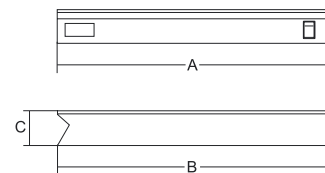

	watt		°C	mm	mm	mm	mm	kg	mm	kg
Night & Day	70	1ph	+8 ÷ +70	350x350	350	380	100	7	410x440x215	8
Vista Night & Day	70	1ph	+8 ÷ +50	480x290	400	300	500	9	620x430x350	13



NIGHT & DAY



# VISTA EASYCOLD

vetrinette refrigerate  
refrigerated display cabinets



- Struttura in alluminio anodizzato con inserti in acciaio inox.
- Ante in plexiglass trasparente antiurto con apertura su entrambi i lati.
- Vasca stagna refrigerata in acciaio inox.
- Temperatura min. 3° C.
- Termostato digitale con visualizzatore temperatura.
- Vaschette non comprese.

**Opzioni:**

- Led di illuminazione da 20 watt.

**EASYCOLD 100 CAPACITÀ:**

- 2 vaschette 1/2 gastronorm h. 40 mm
- 4 vaschette 1/4 gastronorm h. 40 mm

**EASYCOLD 130 CAPACITÀ:**

- 3 vaschette 1/2 gastronorm h. 40 mm
- 6 vaschette 1/4 gastronorm h. 40 mm

- Structure in anodized aluminum with inserts in stainless steel.
- Doors in transparent collision-proof Plexiglas that open on both sides.
- Airtight tank in stainless steel.
- Min. temperature 3° C.
- Digital thermal switch with temperature display.
- Trays not included.

**Optional:**

- Lighting Led, 20 watt.









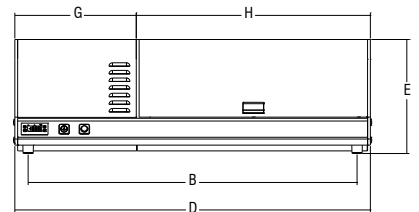
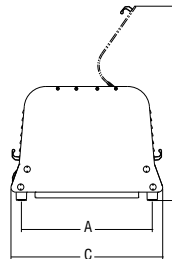





**EASYCOLD 100 CAPACITY:**

- 2 trays 1/2 gastronorm h. 40 mm
- 4 trays 1/4 gastronorm h. 40 mm

**EASYCOLD 130 CAPACITY:**

- 3 trays 1/2 gastronorm h. 40 mm
- 6 trays 1/4 gastronorm h. 40 mm



														
	watt		°C	mm	mm	mm	mm	mm	mm	mm	mm	kg	mm	kg
<b>Vista Easycold 100</b>	150	1ph	min. 3	374	870	434	950	220	395	280	670	28	500x1200x600	30
<b>Vista Easycold 130</b>	150	1ph	min. 3	374	1200	434	1280	220	395	280	1000	33	500x1400x600	35



VISTA EASYCOLD 100



VISTA EASYCOLD 130



GW



## girawürstel hot dog warmer



GW 5

- Girawürstel a rulli, ideale per paninoteche, snack-bars, fast-foods. Cuoce in modo rapido e uniforme, würstel e salsicce che acquistano così il sapore e la colorazione tipici della cottura alla griglia senza che sia necessario rigirarli manualmente.
- Realizzato in lamiera di acciaio inox.
- Motore asincrono con riduttore di velocità ad ingranaggi.
- Spalle laterali che sostengono i rulli in acciaio inox contenenti delle resistenze corazzate.









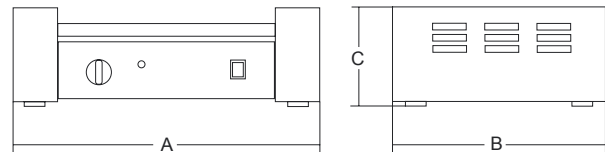

**Opzioni:**

- Rulli teflonati.
- *The roller-type wurstel heater is ideal in fast-food retailers, bars and pubs. It allows a fast and even cooking of wurstels and sausages which will get the taste and the browning of grilled meat without having to turn them over manually.*
- *Made from stainless steel body.*
- *Asynchronous motor with gear-box reducer.*
- *S/S rolls with shock-proof heating elements.*

**Optional:**

- *Teflon-coated rolls.*



										
	watt	1ph	n.	mm	mm	mm	mm	kg	mm	kg
GW 5	850	1ph	5	ø25x350	450	230	170	7.5	550x400x260	8.5
GW 7	1.400	1ph	7	ø25x460	560	300	170	11	700x480x240	12
GW 9	1.650	1ph	9	ø25x460	560	375	180	13	700x480x240	14.5



GW 7



GW 9



# HOT DOG - ROBERTO

scaldawürstel e scaldapane  
hot dog warmers and bread warmers

## HOT DOG

- Contenitore in pirex per la cottura del wurstel.
- Cesto di contenimento wurstel in acciaio inox.
- Regolazione della potenza con simostato.
- Componenti elettrici auto-protetti da eventuali perdite di liquidi.
- Riscaldatori pane in alluminio anodizzato.

## ROBERTO

- Regolazione della potenza tramite simostato.
- Componenti elettrici auto-protetti da eventuali perdite di liquidi.
- Riscaldatori pane in alluminio anodizzato.

## HOT DOG

- Pyrex container for steaming hot dogs.
- Stainless steel basket for hot dogs.
- Heating up controlled by a symostat.
- Sealed electric components protected against leaks.
- Anodized aluminium bun warmers.

## ROBERTO

- Heating up controlled by a symostat.
- Sealed electric components protected against leaks.
- Anodized aluminium bun warmers.



HOT DOG 3

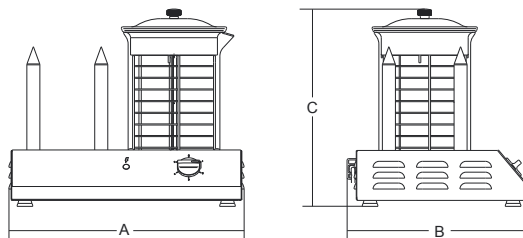

	watt	1ph	n.	mm	n.	mm	mm	mm	kg	mm	kg
<b>HOT DOG</b>	600	1ph	3	ø152 x h.194	30	450	320	365	9.5	500x370x500	11
<b>HOT DOG</b>	600	1ph	4	ø152 x h.194	30	450	320	365	10	500x370x500	11.5
<b>Roberto</b>	875	1ph	6	-	-	450	320	294	8	500x370x500	9.5



HOT DOG 4



ROBERTO



# TW





## tagliawürstel würstelcutter

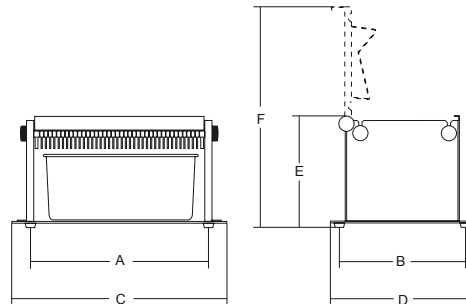

TW 6

- Tagliawürstel manuale in acciaio inox, semplice da usare e da pulire. Taglia con facilità würstel, uova, pomodori, peperoni; basta infatti appoggiare il prodotto sulle lame e abbassare il coperchio fino alla sua completa chiusura, e le fettine cadranno automaticamente nella vaschetta sottostante, già pronte per essere utilizzate.
- *Manual stainless steel wurstelcutter, easy to use and to clean. It cuts easily wurstels, eggs, tomatoes, peppers: you just need to put the product on the blades, then to pull down the lid to its complete closure and the slices will fall down into the container below, ready to be used.*



											
	mm	n.	mm	mm	mm	mm	mm	mm	kg	mm	kg
TW 6	6	34	240	160	280	170	170	270	2.5	320x210x220	3
TW 12	12	17	240	160	280	170	170	270	2.5	320x210x220	3



# HERCULES 5-10-15

## impastatrici pizza dough mixers



YouTube

- Struttura in acciaio a grosso spessore.
  - Verniciatura antigraffio a polveri epossidiche alimentare.
  - Vasca con bordo rinforzato e asta rompi pasta in acciaio AISI 304.
  - Spirale forgiata.
  - Coperchio vasca conforme alle normative.
  - Motore potente e ventilato.
  - Trasmissione moto interno con catena rinforzata.
  - Comandi a bassa tensione resistenti IP 67.
  - Disponibile versione con timer a richiesta per i mod. 10-15.
- 
- *Made from large thickness steel.*
  - *Scratch resistant powder coating.*
  - *Bowl with reinforced edge and AISI 304 S/S shaft.*
  - *Forged spiral tool.*
  - *Container lid conforms to regulations.*
  - *Powerful and ventilated motor.*
  - *Reinforced chain drive.*
  - *Low voltage IP67 protection rated controls.*
  - *On request timer version for mod. 10-15.*



HERCULES 10



HERCULES 5



HERCULES 15





Coperchio vasca conforme alle normative  
*Container lid conform to regulations*



Coperchio sollevabile  
*Lifttable lid*



Asta rompipasta  
*Shaft*



Comandi con timer opzionale  
*Controls with optional timer*



P. 263

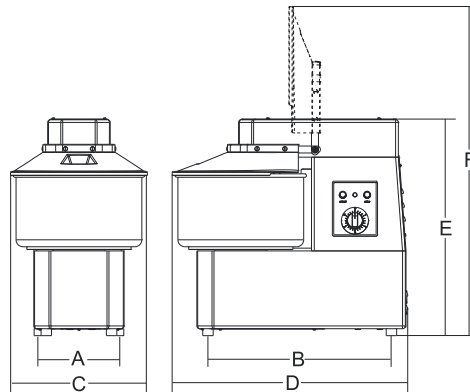

	watt/HP	r.p.m.	r.p.m.	lt	kg	mm	mm	mm	mm	mm	mm	mm	kg	mm	kg	
<b>Hercules 5</b>	370/0.50	1ph	13	83	7	4	ø 265x140	220	410	280	505	440	670	36	500x630x650	42
<b>Hercules 10</b>	370/0.50	1ph/3ph	13	83	12	8	ø 280x190	250	490	305	580	560	825	44	570x720x700	54
<b>Hercules 15</b>	550/0.75	1ph/3ph	13	83	16	12	ø 320x200	250	500	340	590	560	850	48	570x720x700	58



# HERCULES 20-30-40-50



YouTube

## impastatrici pizza dough mixers

- Struttura in acciaio C40 a grosso spessore.
- Verniciatura antigraffio a polveri epossidiche alimentare.
- Vasca con bordo rinforzato e asta rompi pasta in acciaio AISI 304.
- Spirale forgiata.
- Coperchio vasca conforme alle normative con foro per aggiunta prodotto in lavorazione.
- Motore potente e ventilato con riduttore a vite senza fine a bagno d'olio.
- Protezione termica motore.
- Trasmissione moto interno con catena rinforzata.
- Comandi a bassa tensione resistenti IP 67.

### VERSIONE TA

- Testa sollevabile.
- Vasca asportabile.

### Opzioni:

- Ruote, timer e coperchio griglia.
- 2 velocità.
- *Made from large thickness C40 steel.*
- *Scratch resistant powder coating.*
- *Bowl with reinforced edge and AISI 304 S/S shaft.*
- *Forged spiral tool.*
- *Lid with opening to add ingredients during operation.*
- *High efficiency ventilated motor with oil-bath gear box.*
- *Thermal overload protection circuit breaker.*
- *Reinforced chain drive.*
- *Low voltage IP67 protection rated controls.*

### TA VERSION

- *Liftable head for tank removal and easy clearing.*
- *Removable container.*

### Optionals:

- *Wheels, timer and grill cover.*
- *2 speed version.*



HERCULES 40 TA



Testa sollevabile  
Liftable head



Asta rompipasta  
Shaft



Comandi con timer opzionale  
Controls with optional timer



Comandi 2V  
2V controls



Coperchio con foro per aggiunta prodotto  
Lid with opening to add ingredients

HERCULES

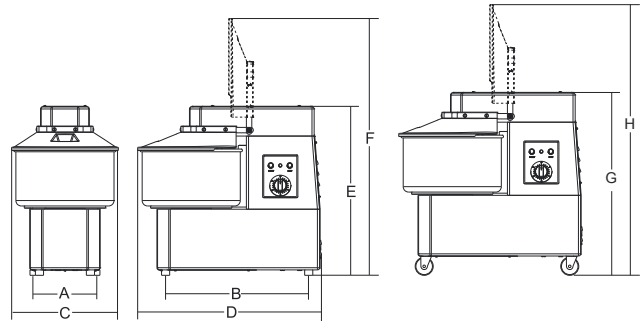

HERCULES TA

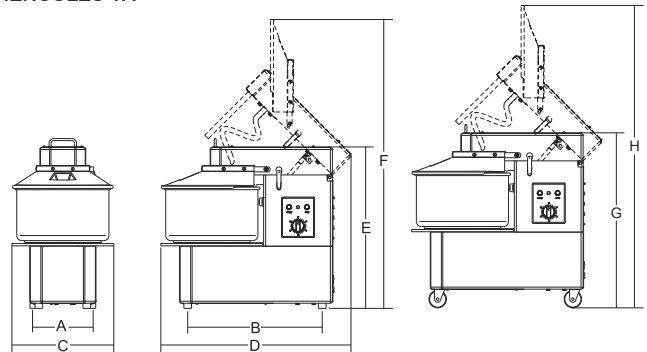

P. 263

	watt/HP		r.p.m.	r.p.m.	lt	kg	mm	mm	mm	mm	mm	mm	mm	mm	mm	kg	mm	kg
<b>Hercules 20B</b>	750/1	1ph/3ph	10	85	21	17	ø 360x210	230	530	390	680	625	950	705	1030	66	530x830x1020	76
<b>Hercules 20</b>	750/1	1ph/3ph	10	85	21	17	ø 360x210	230	530	390	680	625	950	705	1030	70	530x830x1020	80
<b>Hercules 30</b>	1.100/1,5	1ph/3ph	10	85	32	25	ø 400x260	270	590	440	740	700	1050	780	1130	95	530x830x1020	105
<b>Hercules 40</b>	1.500/2	1ph/3ph	10	85	41	35	ø 452x260	310	660	480	825	730	1135	810	1215	105	630x970x1070	115
<b>Hercules 50</b>	1.500/2	1ph/3ph	10	85	52	44	ø 500x270	310	680	540	880	750	1205	830	1285	118	630x970x1070	128
<b>Hercules 20 2V</b>	750-1.100/ 1-1.5	1ph/3ph	1V= 10 2V= 20	1V= 85 2V= 170	21	17	ø 360x210	230	530	390	680	625	950	705	1030	70	530x830x1020	80
<b>Hercules 30 2V</b>	1.300-1.700/ 1.8-2.3	1ph/3ph	1V= 10 2V= 20	1V= 85 2V= 170	32	25	ø 400x260	270	590	440	740	700	1050	780	1130	95	530x830x1020	105
<b>Hercules 40 2V</b>	1.500-2.200/ 2-3	1ph/3ph	1V= 10 2V= 20	1V= 85 2V= 170	41	35	ø 452x260	310	660	480	825	730	1135	810	1215	105	630x970x1070	115
<b>Hercules 50 2V</b>	1.500-2.200/ 2-3	1ph/3ph	1V= 10 2V= 20	1V= 85 2V= 170	52	44	ø 500x270	310	680	540	880	750	1205	830	1285	118	630x970x1070	128
<b>Hercules 20 TA</b>	750/1	1ph/3ph	10	85	21	17	ø 360x210	230	530	400	751	635	1125	715	1205	88	530x830x1020	98
<b>Hercules 30 TA</b>	1.100/1,5	1ph/3ph	10	85	32	25	ø 400x260	270	590	440	823	710	1260	790	1340	109	530x830x1020	119
<b>Hercules 40 TA</b>	1.500/2	1ph/3ph	10	85	41	35	ø 452x260	310	660	490	910	740	1360	820	1440	125	630x970x1070	135
<b>Hercules 50 TA</b>	1.500/2	1ph/3ph	10	85	52	44	ø 500x270	310	680	540	970	795	1415	875	1495	118	630x970x1070	128

# P-ROLL 320 - 420

## stendipizza rolling machine

- Stendipizza ideali per spianare pizze, focacce, pane, ecc. La lavorazione si svolge a freddo per non alterare le proprietà dell'impasto.
  - Lo spessore e il diametro della pasta si possono facilmente regolare in base alle singole esigenze dell'utilizzatore. Costruzione in acciaio inox AISI 304. Scivolo in acciaio AISI 430 facilmente smontabile per una pratica pulizia. Raschiatori rullo inferiore e superiore facilmente smontabili per pulizia. Comandi in acciaio inox IP 67 con NVR.
  - Protezioni salvamano di serie su entrambi i rulli.
  - Pedaliera opzionale.
- 
- *Rolling machine perfect for rolling pizzas, focacce (flat bread), bread etc. Rolling is done cold so as not to alter the properties of the dough.*
  - *The thickness and diameter of the dough can be easily adjusted according to the user's specific needs. AISI 304 stainless steel body. Slide made of AISI 430 steel that can be easily dismantled for handy cleaning. Scrapers on the top and bottom rollers that can be easily dismantled for cleaning. Controls in IP 67 stainless steel with NVR.*
  - *Standard hand-protector guards on both rollers.*
  - *Optional pedal control.*



P-ROLL 420/2



P-ROLL 420 RP



P-ROLL 320/1











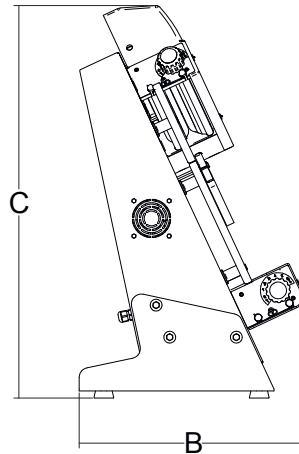
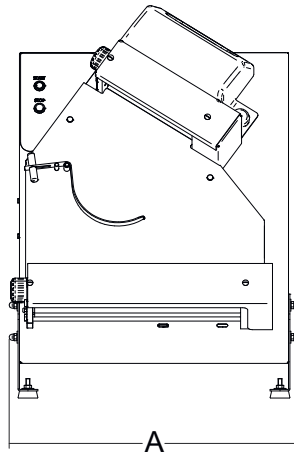



Pedaliera opzionale  
*Optional pedal controls*



**P-ROLL 320/2**



									
	watt/HP		mm	mm	mm	mm	kg	mm	kg
<b>P-ROLL 320/1</b>	250/0.33	1ph	320	487	405	393	-	-	-
<b>P-ROLL 320/2</b>	250/0.33	1ph	320/320	487	462	716	-	-	-
<b>P-ROLL 420/2</b>	250/0.33	1ph	320/420	587	462	796	-	-	-
<b>P-ROLL 420 RP</b>	250/0.33	1ph	320/420	587	462	700	-	-	-









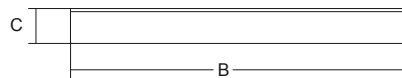
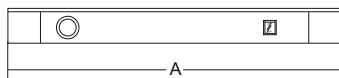

# PIASTRA SCALDAPIZZA

*piastra scaldapizza*  
*pizza warmers*

- Struttura robusta e compatta.
  - Costruita interamente in acciaio inox AISI 340.
  - Resistenze corazzate protette contro gli impatti accidentali.
  - Temperatura regolabile con termostato da 0 a 60 °C
  - Spia luminosa per segnalazione rete.
- 
- *Sturdy and compact structure.*
  - *Made from AISI 340 stainless steel.*
  - *Shock-proof heating elements.*
  - *Temperature adjustable by means of a thermostat from 0 to 60°C*
  - *Pilot light.*



									
	watt	1ph	°C	mm	mm	mm	kg	mm	kg
<b>Piastra Scaldapizza Inox</b>	430	1ph	0÷60	500	500	90	13.4	550x550x150	15



# VETRINETTE D. 38-42

vetrinette pizza brioche  
pizza and pastry display cabinets



VETRINETTA D.42

- Vetrinetta per l'esposizione di pizze, brioche, torte, sfoglie e stuzzichini vari, che mantiene costante la temperatura e conserva a lungo il sapore e la morbidezza dei cibi.
- Costruita interamente in acciaio AISI 403 con vetri sui quattro lati.
- Porta con chiusura soft calamitata.
- Termostato di regolazione temperatura.
- Cassetto acqua per l'umidificazione dei prodotti.
- Ripiani girevoli che favoriscono una omogenea circolazione del calore e una migliore visione dei prodotti.
- *Display unit suitable to keep warm and fragrant for many hours pizza, pastries, savoury pies and many other snacks.*
- *Made from stainless steel AISI 403 and glass sides.*
- *Door with magnetic closure.*
- *Temperature adjustable by means of a thermostat.*
- *Small water basin for humidification of the product.*
- *Swivelling racks help a uniform heat diffusion and a better product view.*

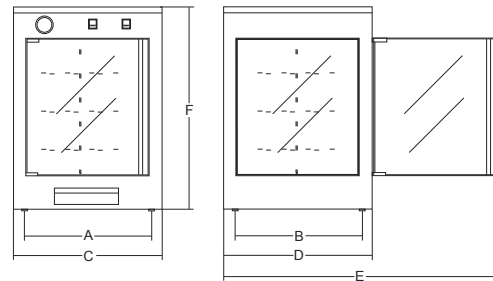

	watt	1ph	°C	mm	mm	mm	mm	mm	mm	kg	mm	kg
<b>Vetrinetta D.38</b>	700	1ph	0÷90	390	360	465	430	820	590	23	600x600x800	30
<b>Vetrinetta D.42</b>	700	1ph	0÷90	430	400	505	470	960	590	25	600x600x800	32



VETRINETTA D.38



# FORNO PIZZA







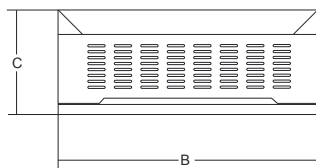
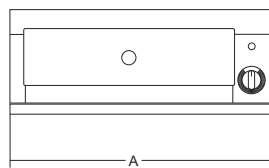



*pizza oven*

- Forma robusta e compatta, studiata appositamente per sovrapporre altri forni pizza o la vetrinetta per l'esposizione.
- Realizzato totalmente in acciaio inox AISI 304.
- Resistenze corazzate in acciaio.
- Griglia di cottura in acciaio cromato.
- Pannelli isolanti a norme per un ottimo isolamento su tutte le superfici del forno.
- Temperatura di lavoro pre-impostata.
- Timer per la regolazione del tempo di cottura.
- Manopola ad elevata resistenza termica.
- Spia luminosa per la segnalazione presenza rete.

- *Compact and sturdy structure, designed to hold up other ovens or one Vetrinetta pizza displayer.*
- *Made from AISI 304 stainless steel.*
- *Shock-proof stainless steel heating elements.*
- *Galvanized steel grill.*
- *CE approved lining for thermal protection.*
- *Adjustable working temperature.*
- *Timer.*
- *Heat resistant knob.*
- *Pilot light.*



Impilabile con la vetrinetta D.38  
Stacking with Vetrinetta D. 38

										
	watt	ph	°C	mm	mm	mm	mm	kg	mm	kg
<b>Forno Pizza</b>	1.000+750	1ph	0+330	360x430 h.70	465	430	170	12	520x580x240	13.5

# STROMBOLI



## forni pizza pizza ovens

- Struttura in acciaio inox.
- Piano di cottura in pietra refrattaria.
- Resistenze corazzate.
- Sfiato per i vapori di cottura.
- Capacità per piano: 2 pizze Ø ≤ mm 225

- Structure in stainless steel.
- Refractory brick deck.
- Shock-proof coated heating elements.
- Shock-proof heating elements.
- Capacity to 1 level: 2 pizzas Ø ≤ mm 225



STROMBOLI 2

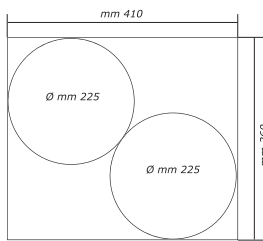

Piano di cottura in pietra refrattaria  
Refractory brick deck.



Comandi  
Controls

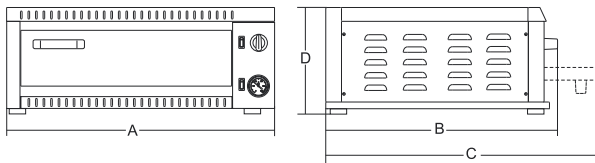

						<b>A</b>	<b>B</b>	<b>C</b>	<b>D</b>			
	watt	1ph	min.	°C	mm	mm	mm	mm	mm	kg	mm	kg
<b>Stromboli</b>	1.600	1ph	30	50 ÷ 350	410x360 h.80	580	490	550	245	22.5	660x540x320	25
<b>Stromboli 2</b>	3.200	1ph	30	50 ÷ 350	410x360 h.80 (x2)	580	490	550	420	37	660x540x480	40



STROMBOLI



# VULCANO

forni pizza  
*pizza ovens*

- Struttura in acciaio inox
  - Piani di cottura in pietra refrattaria
  - Resistenze corazzate
  - Sfiato per i vapori di cottura
  - Isolamento in fibra di ceramica
  - 2 camere di cottura indipendenti isolate termicamente
  - 2 termostati per ogni camera che regolano la zona inferiore e superiore.
- 
- *Stainless steel construction.*
  - *Refractory brick decks.*
  - *Shock-proof, coated heating elements*
  - *Air-hole*
  - *Ceramic fibre lining.*
  - *2 separate backing chambers thermal insulated.*
  - *2 thermostats for each chamber which select the lower and upper zone.*



## VULCANO 2C



Piano di cottura in pietra refrattaria  
*Refractory brick deck.*

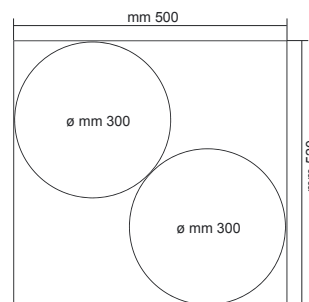
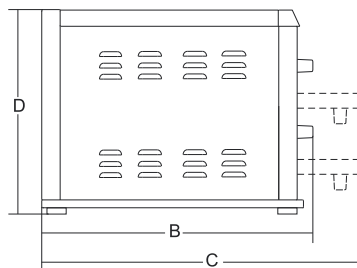
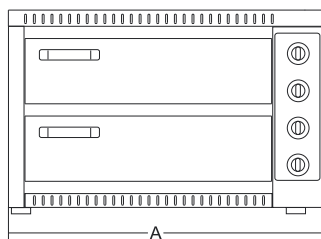

					<b>A</b>	<b>B</b>	<b>C</b>	<b>D</b>			
	watt		°C	mm	mm	mm	mm	mm	kg	mm	kg
<b>Vulcano 2C</b>	6.400	1ph/3ph	50+350	500x520 h.115	745	695	780	490	75	890x800x650	86

# VESUVIO

forni pizza  
pizza ovens



Cappa aspirante opzionale  
*Fume hood optional*

Cavalletto in alluminio con porta cassette pizza opzionale  
*Aluminium stand with pizza trays holder optional*

- Struttura esterna in acciaio inox.
  - Porta in acciaio inox con finestra a doppio vetro.
  - Termometro per la visualizzazione della temperatura camera.
  - 2 termostati per controllo separato delle resistenze inferiori e superiori.
  - Doppia illuminazione interna.
  - Piano cottura in pietra refrattaria.
  - Camino per il convogliamento di fumi e vapori.
  - Cappa aspirante (230V/50Hz - watt 100) opzionale.
  - I forni 85x70, 105x70 e 105x105 possono contenere 2 teglie da cm 60x40.
- *S/steel construction.*
  - *Stainless steel door with double glass window.*
  - *It is possible to check the temperature inside the chamber by means of a thermometer.*
  - *Heating of the upper and lower elements is adjustable by means of 2 separate symostats.*
  - *Double interior lighting.*
  - *Refractory brick deck*
  - *Fumes and vapour chimney.*
  - *Fume hood (230V/50Hz) optional.*
  - *Fits 2x 60x40 cm trays for Vesuvio 85x70, 105x70 and 105x105.*



Piano di cottura in pietra refrattaria  
*Refractory brick deck.*



Cavalletto alluminio opzionale  
*Optional aluminium stand*



Cavalletto in alluminio con porta cassette pizza opzionale  
*Aluminium stand with pizza trays holder optional*

**Vesuvio 70x70**

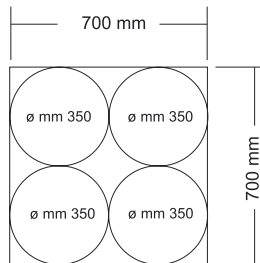
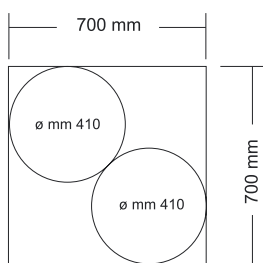

**Vesuvio 85x70**

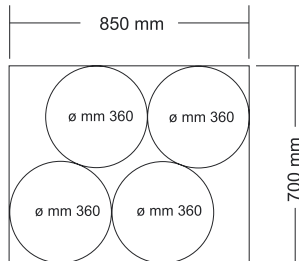
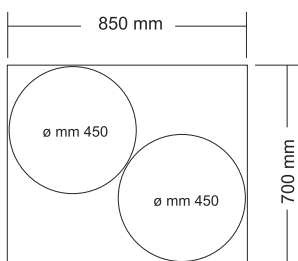

**Vesuvio 105x70**

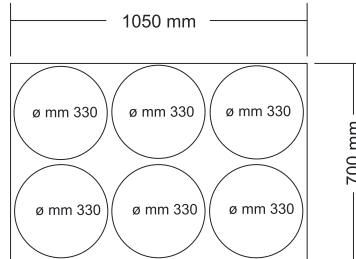
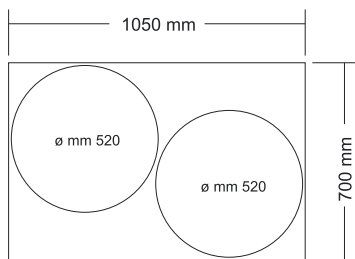

**VESUVIO 70X70**



**VESUVIO 105X70**





### VESUVIO 105X105 2C

Mantello esterno in lamiera nera preveniciata a polvere.  
Cappa aspirante con luci a Led opzionale.  
Porta in acciaio inox con finestra intera a doppio vetro.  
Cavalletto in alluminio con porta cassette pizza opzionale.

### VESUVIO 105X105 2C

*External body in black oven prepainted steel  
Optional hood with Led lights.  
Stainless steel door with two handles and panoramic window.  
Optional aluminium stand with trays holder.*



Comandi elettronici  
*Digital control panel*



Doppia illuminazione interna  
*Dual internal lighting*









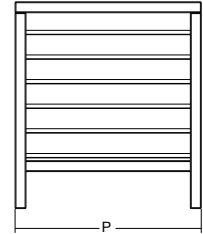
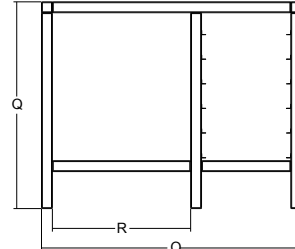
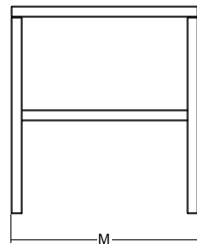
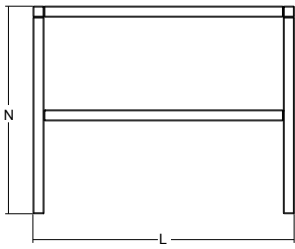























Cappa aspirante con luci a Led opzionale  
*Optional hood with Led lights*

Cavalletto alluminio standard  
*Standard aluminium table base*









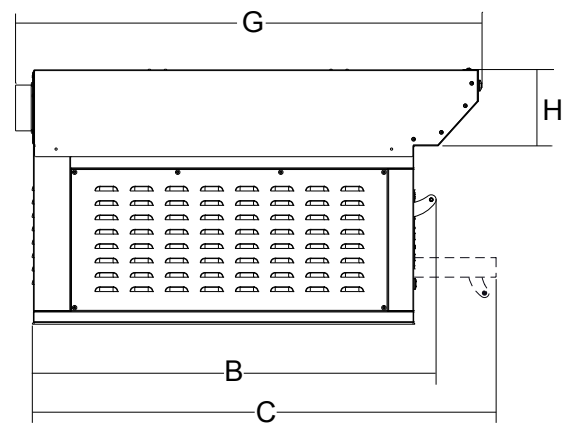
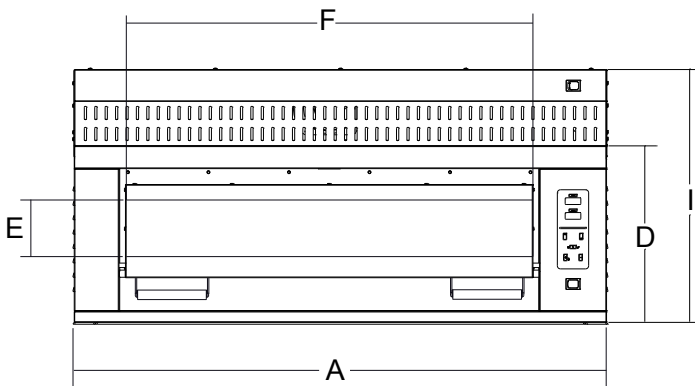







Cavalletto alluminio con porta cassetta pizza  
*Aluminium table base with pizza trays holder*



	L	M	N	
	mm	mm	mm	n.
Vesuvio 70x70	995	855	950	
	995	855	1150	
Vesuvio 85x70	1195	855	950	
	1195	855	1150	
Vesuvio 85x70 2C	1195	855	950	
	1195	855	1150	
Vesuvio 105x70	1395	855	950	
	1395	855	1150	
Vesuvio 105x70 2C	1395	855	950	
	1395	855	1150	
	1395	855	1150	
Vesuvio 105x105	1395	1242	950	
	1395	1242	1150	

	O	P	Q	R	cm 60x40	
	mm	mm	mm	mm	n.	n.
Vesuvio 70x70	995	855	950	435	6	
	995	855	1150	435	7	
Vesuvio 85x70	1195	855	950	635	6	
	1195	855	1150	635	7	
Vesuvio 85x70 2C	1195	855	950	635	6	
	1195	855	1150	635	7	
Vesuvio 105x70	1395	855	950	635	6+6	
	1395	855	1150	635	7+7	
Vesuvio 105x70 2C	1395	855	950	635	6+6	
	1395	855	1150	635	7+7	
	1395	855	1150	635	7+7	
Vesuvio 105x105	1395	1242	950	635	6+6	
	1395	1242	1150	635	7+7	



																
	watt		°C	mm	mm	mm	mm	mm	mm	mm	mm	mm	mm	kg	mm	kg
<b>Vesuvio 70x70</b>	5.850	3ph+N	0÷350	700x700 h.149	995	900	1015	395	119	700	1038	171	566	78	1140x2140x600	102
<b>Vesuvio 85x70</b>	7.200	3ph+N	0÷350	850x700 h.149	1190	905	1015	395	119	850	1038	171	566	93	1240x1320x600	118
<b>Vesuvio 85X70 2C</b>	7.200 (x2)	3ph+N	0÷350	850x700 h.149 X2	1190	905	1015	720	119	850	1038	171	891	166	1240x1320x1200	187
<b>Vesuvio 105x70</b>	9.000	3ph+N	0÷350	1050x700 h.149	1395	920	1030	365	119	1050	1112	221	586	105	1290x1520x600	135
<b>Vesuvio 105x70 2C</b>	9.000 (x2)	3ph+N	0÷350	1050x700 h.149 x2	1395	920	1030	660	119	1050	1112	221	881	230	1290x1520x1200	260
<b>Vesuvio 105x105</b>	13.500	3ph+N	0÷350	1050x1050 h.149	1395	1280	1030	365	119	1050	1445	260	625	165	1540x1520x600	202
<b>Vesuvio 105x105 2C</b>	13.500 (x2)	3ph+N	0÷350	1050x1050 h.149 x2	1395	1280	1030	660	119	1050	1445	260	881	220	-	-





# PIZZA

## accessori per la pizza

### *pizza accessories*

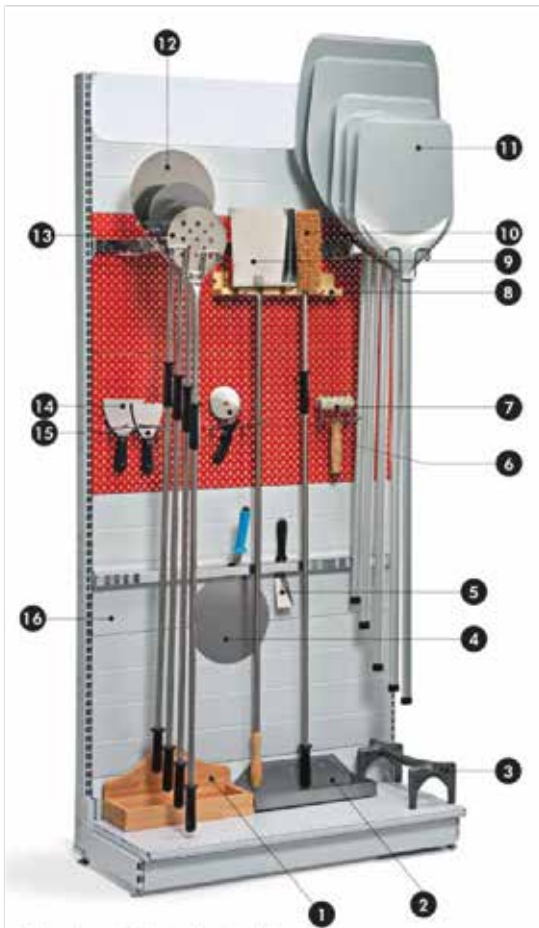

- Aluminium shovels, light and handy (11):
  - cm 30x33 h.170
  - cm 33x33 h.170
  - cm 36x36 h.170
  - cm 45x45 h.170
  - cm 50x50 h.170

- Stainless steel little shovels with anti-burn anatomic available in two versions:

Normal (12):

- cm  $\varnothing$  16 h.170
- cm  $\varnothing$  18 h.170
- cm  $\varnothing$  20 h.170
- cm  $\varnothing$  26 h.170

Punched (13):

- cm  $\varnothing$  16 h.170
- cm  $\varnothing$  18 h.170
- cm  $\varnothing$  20 h.170

- Dustpan ash collecting h.170 (9)
- Natural fibre long-hoedled scrubbing-brush (10)
- Wall support to hanger 3 little shovels and 2 shovels (8)
- Wall support to hang little shovels (7)
- Column support to hang shovels pizza (18)
- Wall support to stand shovels (17)
- Wooden case to stand shovels (1)
- Stainless steel case to stand shovels (2)
- Firedog for firewood (3)
- Aluminium alloy puff-pierce (7)
- "Cacciapizza" pizza server shovel (4)
- Pizza cutter roller d. 90 mm (6)
- Stainless steel spatula cm 10 (15)
- Stainless steel spatula cm 12 (14)
- "Paletta Servipizza" pizza server, stainless steel cm (5)
- Polyethylene cutting board  $\varnothing$  cm 33
- Polyethylene cutting board  $\varnothing$  cm 40
- Polyethylene cutting board  $\varnothing$  cm 50
- Pizza accessories exhibitor (16)

- Pale in alluminio leggere e maneggevoli (11):

- cm 30x33 h.170
- cm 33x33 h.170
- cm 36x36 h.170
- cm 45x45 h.170
- cm 50x50 h.170

- Palini in acciaio inox con impugnatura anatomica antiscottamento, disponibili in due modelli:

Normali (12):

- cm  $\varnothing$  16 h.170
- cm  $\varnothing$  18 h.170
- cm  $\varnothing$  20 h.170
- cm  $\varnothing$  26 h.170

Forati (13):

- cm  $\varnothing$  16 h.170
- cm  $\varnothing$  18 h.170
- cm  $\varnothing$  20 h.170

- Paletta per raccolta cenere h.170 (9)
- Spazzolone in fibra naturale (10)
- Supporto a muro per appendere 3 palini e 2 pale (8)
- Supporto a muro per appendere palini (7)
- Supporto a colonna per appendere le pale (18)
- Supporto a muro per appoggiare le pale (17)
- Cassetta in legno per appoggiare le pale (1)
- Cassetta in acciaio per appoggiare le pale (2)
- Alare per appoggio legna (3)
- Bucastaglia in lega di alluminio (7)
- Cacciapizza in acciaio (4)
- Rotella taglia pizza d. 90 mm (6)
- Spatole in acciaio inox cm 10 (15)
- Spatole in acciaio inox cm 12 (14)
- Paletta servi pizza cm 5x13 (5)
- Tagliere in polietilene per pizza,  $\varnothing$  cm 33
- Tagliere in polietilene per pizza,  $\varnothing$  cm 40
- Tagliere in polietilene per pizza,  $\varnothing$  cm 50
- Espositore accessori per la pizza (16)



P. 78

## LINEA BAR

Strumenti indispensabili per spremere, frullare, amalgamare, montare e preparare bevande adatte a soddisfare qualsiasi palato, le macchine da bar firmate Sirman sono tutte progettate e realizzate per garantire: la massima sicurezza nell'uso, pulizia e manutenzione; un'assoluta igiene grazie alla selezione di materiali adatti al contatto con gli alimenti e all'eliminazione degli spigoli nelle parti della macchina destinati al contatto col prodotto; una perfetta resa, robustezza e stabilità di tutti i componenti e, ancora, la più totale silenziosità e maneggevolezza.

Caratterizzati da un design brillante ed innovativo, volto ad unire armonicamente estetica e funzionalità, gli strumenti proposti da Sirman sono adatti a soddisfare le più diverse esigenze dei professionisti del settore e, come tali, presenze indispensabili in ogni locale all'avanguardia.

## BAR LINE

*Indispensable tools for squeezing, whisking, blending, whipping and preparing drinks to suit everybody's taste, Sirman drinks bar machines are all designed and manufactured to ensure the utmost safety in use, cleanliness and easy maintenance; absolute hygiene thanks to the selection of materials suitable for contact with foodstuffs and the elimination of any sharp edges in the parts of the machine that come into contact with the food products; great efficiency, sturdiness and stability of all the components and, also important, very low noise levels and easy handling.*

*Characterized by a bright and innovative design, designed to achieve a harmonious combination of good looks and practicality, these tools by Sirman are designed to satisfy a great variety of needs for professionals in this sector and as such, are an indispensable aid in every modern drinks bar.*





# SIRIO

## frappè drink mixers



YouTube

- Famiglia completa di macchine per il frappè caratterizzato da linee morbide e precise. Studiato per un utilizzo professionale e severo nel rispetto delle norme di sicurezza europee e nordamericane.
  - Corpo macchina bianco o cromato, colonna in alluminio estruso e base in pressofusione per una ottima stabilità della macchina, il tutto privo di angoli e giunzioni per facilitare la pulizia.
  - Disponibile nella versione da banco 1 o 2 bicchieri o a parete.
  - Bicchiere da 550 cc in Tritan trasparente o a richiesta in acciaio inox.
  - Bicchiere da 900 cc in acciaio inox su versione da 120 watt.
  - Motore potente e ventilato per una maggiore durata.
  - Versione con 3 fruste in alluminio e acciaio per la preparazione di frappè e sorbetti o con disco appositamente studiato per il caffè shakerato o per montare il prodotto in lavorazione.
  - Microinterruttore di sicurezza sul bicchiere (opzionale per paesi extra UE).
  - Variatore di velocità a richiesta.
- 
- *A complete line of drink mixers with a soft design. Designed to commercial use, they meet all European and North-American safety requirements.*
  - *White or chrome head, aluminium stem and die casting base for a perfect stability, no edges or seams for easier cleaning.*
  - *Countertop (1 or 2 cups) or wall unit versions available.*
  - *Transparent 550 cc Tritan cup or stainless steel cup on request.*
  - *900 cc stainless steel cup on 120 W version.*
  - *Powerful ventilated motor for a longer life.*
  - *Spindle with three aluminium and s/steel agitators for preparing milkshakes and drinks, or with a special round agitator for frozen coffees or for creamier results.*
  - *Safety microswitch on the cup support (optional for non UE countries).*
  - *Speed control on request.*



SIRIO 1 VV - 120W 900CC



SIRIO 1 VV GRIGIO



SIRIO 2 VV











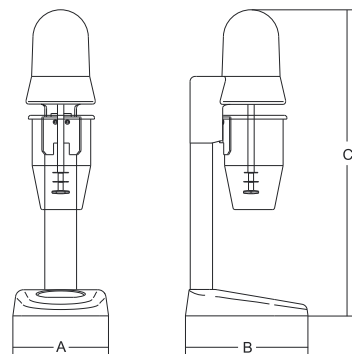

SIRIO 2





Sirio Caffè

Particolare fruste  
AgitatorsOpzionale: Anello portabicchieri usa e getta  
Optional: ring for paper cups

										
	watt/HP		r.p.m.	lt	mm	mm	mm	kg	mm	kg
<b>Sirio 1</b>	100/0.14	1ph	14.000	0.55	150	195	485	2.5	210x250x520	3.5
<b>Sirio 2</b>	100+100/0.14+0.14	1ph	14.000	0.55x2	300	195	485	5	370x260x530	6.5
<b>Sirio 1P</b>	100/0.14	1ph	14.000	0.55	110	150	360	2	190x240x510	4
<b>Sirio 1 VV</b>	100/0.14	1ph	4.000+14.000	0.55	150	195	485	2.5	210x250x520	3.5
<b>Sirio 2 VV</b>	100+100/0.14+0.14	1ph	4.000+14.000	0.55x2	300	195	485	5	370x260x530	6.5
<b>Sirio 1P VV</b>	100/0.14	1ph	4.000+14.000	0.55	110	150	360	2	190x240x510	4
<b>Sirio 1 - 120W 900cc</b>	120/0.16	1ph	14.000	0.9	150	195	530	3	210x250x560	4.5
<b>Sirio 1 VV - 120W 900cc</b>	120/0.16	1ph	4.000-14.000	0.9	150	195	530	3	210x250x560	4.5
<b>Sirio 2 - 120W 900cc</b>	120+120/0.16+0.16	1ph	14.000	0.9x2	300	195	530	6	360x250x560	7
<b>Sirio 2 VV - 120W 900cc</b>	120+120/0.16+0.16	1ph	4.000-14.000	0.9x2	300	195	530	6	360x250x560	7



Sirio 1 / Sirio 1 VV



SIRIO 1P VV



SIRIO 1P



# DRAGONE

## frullatori blenders

- Frullatore nato dalle specifiche esigenze del bar moderno, particolarmente adatto per preparare frullati e bevande di frutta e verdura.
  - Corpo macchina bianco o cromato, privo di angoli e giunzioni per facilitare la pulizia.
  - Motore ad elevata potenza con ventilazione forzata.
  - Bicchiere da 1,5 litri in Tritan trasparente infrangibile, lavabile in lavastoviglie, graduato in litri e galloni UK e USA.
  - Coperchio bicchiere in gomma a perfetta tenuta con tappo e bicchierino graduato per l'aggiunta degli ingredienti durante la lavorazione.
  - Sistema di trasmissione con denti contrapposti in metallo e gomma per una elevata trasmissione della potenza e bassa rumorosità.
  - Coltello a 4 razze ricavato da un unico stampaggio, in acciaio inox da coltelleria facilmente smontabile.
  - Microinterruttore di sicurezza sul coperchio bicchiere.
  - Variatore di velocità a richiesta.
- *Designed to meet the specific needs of the modern bar, it is particularly suitable for preparing smoothies, fruit and vegetables drinks.*
  - *White or chrome body, no edges or seams for easy cleaning.*
  - *Powerful ventilated motor.*
  - *Transparent, unbreakable 1,5 Lt Tritan container is dishwasher safe and graduated with litres and UK/USA gallons.*
  - *Tight rubber lid with feed opening to add ingredients while the blender is working.*
  - *Metal and rubber gears drive gives a high power transmission and quiet operation.*
  - *4-blades stainless steel knife can be easily disassembled.*
  - *Safety microswitch on the lid.*
  - *Speed control on request.*



DRAGONE CROMATO



DRAGONE GRIGIO



Modello caffè  
Coffee model



Micro su coperchio  
Microswitch on cover



Modello VV: variatore di velocità  
Speed control optional

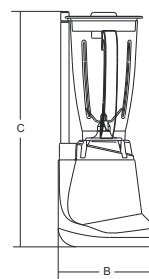
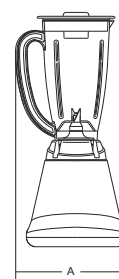

					<b>A</b>	<b>B</b>	<b>C</b>			
	watt/HP	ph	r.p.m.	lt	mm	mm	mm	kg	mm	kg
<b>Dragone</b>	450/0.60	1ph	16.000	1.5	213	200	416	3	310x300x530	4
<b>Dragone VV</b>	450/0.60	1ph	11.000÷16.000	1.5	213	200	416	3	310x300x530	4



# SATURNO

## frullatori blenders



SATURNO

- Frullatore nato dalle specifiche esigenze del bar moderno, particolarmente adatto per preparare frullati e bevande di frutta e verdura.
- Corpo macchina in acciaio inox, privo di angoli e giunzioni per facilitare la pulizia.
- Motore ad elevata potenza con ventilazione forzata.
- Bicchiere da 1,5 litri in Tritan trasparente infrangibile, lavabile in lavastoviglie, graduato in litri e galloni UK e USA.
- Coperchio bicchiere in gomma a perfetta tenuta con tappo e bicchierino graduato per l'aggiunta degli ingredienti durante la lavorazione.
- Sistema di trasmissione con denti contrapposti in metallo e gomma per una elevata trasmissione della potenza e bassa rumorosità.
- Coltello a 4 razze ricavato da un unico stampaggio, in acciaio inox da coltelleria facilmente smontabile.
- Microinterruttore di sicurezza sul coperchio bicchiere.
- Variatore di velocità a richiesta.

- *Designed to meet the specific needs of the modern bar, it is particularly suitable for preparing smoothies, fruit and vegetables drinks.*
- *Seamless stainless steel body for easy cleaning.*
- *Powerful ventilated motor.*
- *Transparent, unbreakable 1,5 lt Tritan container is dishwasher safe and graduated with litres and UK/USA gallons.*
- *Tight rubber lid with feed opening to add ingredients while the blender is working.*
- *Metal and rubber gears drive gives a high power transmission and quiet operation.*
- *4-blades stainless steel knife can be easily disassembled.*
- *Safety microswitch on the lid.*
- *Speed control on request.*



Modello caffè  
Coffee model



Micro su coperchio  
Microswitch on cover



Modello VV: variatore di velocità  
Speed control optional

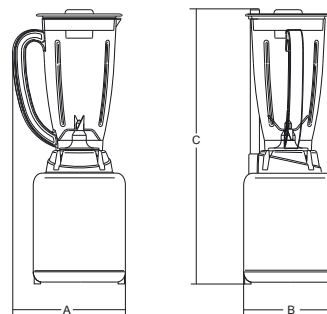

	watt/HP	ph	r.p.m.	lt	mm	mm	mm	kg	mm	kg
<b>Saturno</b>	450/0.60	1ph	16.000	1.5	213	200	416	3.5	310x300x530	4.5
<b>Saturno VV</b>	450/0.60	1ph	11.000/16.000	1.5	213	200	416	3.5	310x300x530	4.5



# ORIONE

## frullatori blenders



YouTube

- Frullatori professionali nati dalle specifiche esigenze del bar, ristorante, mensa, ecc.
- Corpo macchina in alluminio estruso e fianchi in ABS.
- Sistema di tenuta a membrana per prevenire l'ingresso di liquidi all'interno della macchina.
- Potente motore con ventilazione forzata, per un utilizzo prolungato e una maggiore durata.
- Microinterruttore magnetico di sicurezza sul coperchio bicchiere senza posizione obbligatoria.
- Comandi a membrana siliconica con pulsante ON, OFF Pulse e dispositivo NVR.
- Variatore di velocità.
- Coperchio bicchiere in gomma con tappo per l'aggiunta di ingredienti.
- Corpo mozzo di trasmissione in acciaio inox, facilmente separabile dal corpo bicchiere per una facile pulizia.
- Albero coltelli supportato da cuscinetti a sfere per prevenire il surriscaldamento e garantire una lunga durata.
- Trascinatore a stella in acciaio sinterizzato ad alta resistenza.
- Coltello a 4 razze ricavato da un unico stampaggio in acciaio da coltelleria temperato adatto anche per tritare ghiaccio.



ORIONE Q VV



ORIONE T VV

### MODELLO Q

- Bicchiere quadro da 2 litri, realizzato in materiale trasparente infrangibile, graduato in litri, galloni UK e USA.
- Il bicchiere quadro è stato sviluppato per lavorare al meglio con grandi quantità di ghiaccio anche a secco, pratico e funzionale, si può versare il prodotto su 3 diverse direzioni.
- Ideale per la preparazione di frozen drink o smoothies con sciroppi e concentrati.

### MODELLO T

- Bicchiere tondo da 2 litri ideale per frullati e frozen, realizzato in materiale trasparente infrangibile, graduato in litri, galloni UK e USA.
- Optional: bicchiere inox da 2 litri, ideale per frullati e frozen.

### ALTRI MODELLI Q/T

- Modello 2 bicchieri
- Modello Timer: timer a regolazione manuale e spegnimento automatico della macchina.
- Modello Plus: versione elettronica con 9 programmi di lavorazione preimpostati.

### MODELLO 5 LITRI

- Corpo macchina in acciaio inox.
- Bicchiere tondo in acciaio inox da 5 litri.
- Coperchio bicchiere in PE e guarnizione di tenuta bloccato con cerniere, tappo per l'aggiunta di ingredienti.
- Albero coltelli supportato da boccole in bronzo.
- Trascinatore metallico con denti contrapposti ideale per resistere alle lavorazioni con prodotti caldi.



ORIONE 2 Q VV



ORIONE 2 T VV



ORIONE FIVE

- Professional mixer designed to cater for specific requirements of bars, restaurants, cafeterias, etc.
- Extruded aluminium machine body and sides in ABS.
- Membrane sealing system to prevent fluids from entering the machine.
- Powerful motor with forced ventilation, for prolonged use and enhanced durability.
- Magnetic safety micro-switch on glass lid without forced position.
- Siliconic membrane controls with ON, OFF Pulse button and NVR device.
- Speed control.
- Glass lid in rubber with plug for adding ingredients.
- Stainless steel transmission hub body; can be easily separated from the glass body for easy cleaning.
- Cutters shaft supported by ball bearings to prevent overheating and to guarantee enhanced durability.
- Star drive in high-resistance sintered steel.
- 4-Spoke cutter obtained from a single pressing of hardened steel for blades also suitable for crushing ice.

**Q MODEL**

- 2-Litre square glass made in unbreakable transparent material, graduated in litres, UK and U.S. gallons.
- Very practical square glass, with possibility of pouring in 3 different directions, ideal in the preparation of frozen drinks, Smoothies with syrups and concentrates.
- Ideal in the preparation of frozen drinks, Smoothies with syrups and concentrates.

**T MODEL**

- Round 2-litre glass, ideal for shakes and frozen drinks, built out of transparent, indestructible material, graduated in litres, UK and U.S. gallons.
- Optional: round 2-litre glass, made in stainless steel, ideal in the preparation of shakes and frozen drinks.

**OTHER MODELS Q/T**

- 2 glass version for T/Q model
- Orione Timer: manual adjustment timer and automatic machine switch-off.
- Orione Plus: electronic version with 9 pre-set processing programs.

**5 LITERS MODEL**

- Machine body in stainless steel.
- 5-Litre round glass in stainless steel.
- Glass lid in PE and sealer, locked with hinges and with plug for adding ingredients.
- Cutters shaft supported by bronze bushes.
- Metal driver with opposing teeth, ideal to withstand processing of hot products.

Comandi VV  
W controlsComandi Timer VV  
Timer W controlsComandi Plus VV  
Plus W controls

# BARMASTER

## frullatori blenders

### MODELLO ELETTRONICO

- 20 programmi pre-impostati di cui 4 associabili ai 4 pulsanti su tastiera, gli altri 16 richiamabili attraverso il menu, tutti riprogrammabili.
- 9 programmi impostati attraverso autoapprendimento.
- Display per la visualizzazione dei programmi e del funzionamento.
- Campana trasparente silenziante disponibile su richiesta.

### ELECTRONIC MODEL

- 20 pre-set programs, of which 4 can be linked to 4 keys on the keypad and the other 16 can be recalled through the menu (all can be reprogrammed).
- 9 programs set in self-learning mode.
- Display to view the programs and machine operation.
- Transparent silencing bell available on request.



**BARMASTER Q**



**BARMASTER Q**  
con campana silenziante opzionale  
*with sound enclosure, optional*



**BARMASTER T**



**BARMASTER T**  
con campana silenziante opzionale  
*with sound enclosure, optional*





Trascinatori inox modello Q  
Stainless steel gears on Q model



Bicchiere tondo inox opzionale  
Optional s/steel round glass



Bicchieri quadrati impilabili  
Stackable square glass

### ORIONE

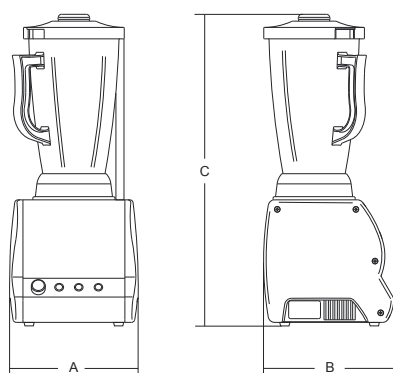

### BARMASTER

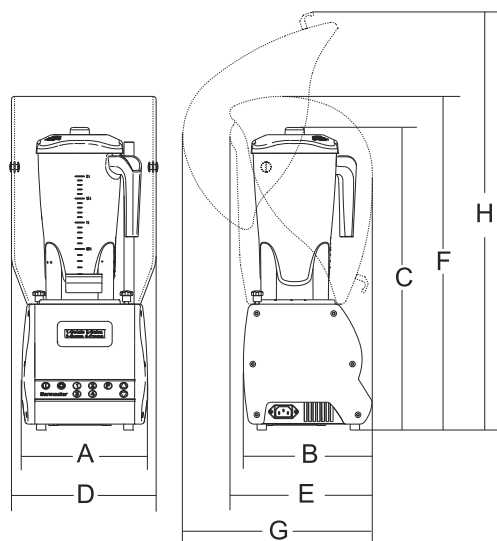

	watt/Hp		r.p.m.	lt	mm	mm	mm	kg	mm	kg
<b>Orione Q VV</b>	750/1	1ph	8.000 ÷ 16.000	2	208	210	490	5	310x300x530	7
<b>Orione T VV</b>	750/1	1ph	8.000 ÷ 16.000	2	208	210	490	5	310x300x530	7
<b>Orione 2 Q VV</b>	750+750/1+1	1ph	8.000 ÷ 16.000	2+2	380	210	490	10	480x300x530	12
<b>Orione 2 T VV</b>	750+750/1+1	1ph	8.000 ÷ 16.000	2+2	380	210	490	10	480x300x530	12
<b>Orione Five</b>	750/1	1ph	8.000 ÷ 16.000	5	245	260	540	7	340x330x640	9

	watt/Hp		r.p.m.	lt	mm	mm	mm	kg	mm	kg
<b>Barmaster Q</b>	750/1	1ph	8.000 ÷ 16.000	2	240	210	490	5	305x305x525	7
<b>Barmaster T</b>	750/1	1ph	8.000 ÷ 16.000	2	240	210	490	5	305x305x525	7
<b>Campana / Sound enclosure</b>	-	-	-	-	-	-	-	1	305x305x525	2



# APOLLO

## spresiagrumi citrus juicers



- Spremiagrumi professionale dal design piacevolmente arrotondato adatto per un utilizzo intenso in tutti i bar che necessitano di una lavorazione semplice ed intuitiva.
- Corpo macchina bianco o cromato, privo di angoli e giunzioni per facilitare la pulizia.
- Vasca di lavorazione in acciaio inox rimovibile per la pulizia ed il lavaggio anche in lavastoviglie; a richiesta vasca in ABS dalle generose dimensioni e una maggiore economicità della macchina.
- Setaccio mobile con due dimensioni di pigna per adattarsi a tutti i tipi di agrume.
- A richiesta versione con leva in alluminio e acciaio inox per lavorare senza sporcarsi le mani.
- Microinterruttore brevettato sulla pigna che permette di accendere direttamente la macchina premendo l'agrumo. Su richiesta senza microinterruttore per una maggiore economicità della macchina.
- Variatore di velocità a richiesta.
- *Commercial easy to use citrus juicer with round design.*
- *White or chrome body, no edges or seams for easy cleaning.*
- *Stainless steel bowl is removable for cleaning and is dishwasher safe, ABS bowl available on request.*
- *Removable sieve with reamer in two sizes to squeeze any kind of citrus.*
- *Aluminium stainless steel lever to avoid any food contact is available on request.*
- *Patented safety microswitch on the cone allows to activate the juicer when the product is pushed down.*
- *Speed control on request.*



Opzionale: coperchio  
Optional: Lid

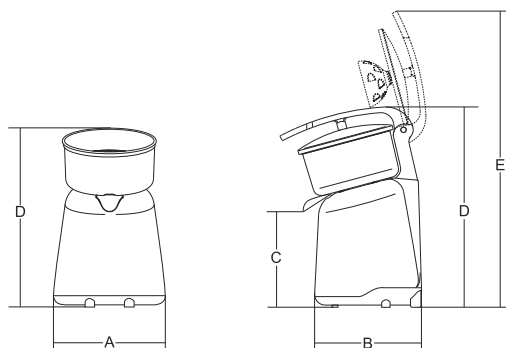

	watt/HP	1ph	r.p.m.	mm	mm	mm	mm	mm	kg	mm	kg
<b>Apollo Eco</b>	150/0.20	1ph	320	210	210	155	310	-	2.5	270x340x370	3.5
<b>Apollo</b>	150/0.20	1ph	320	210	210	155	290	-	3	270x340x370	4
<b>Apollo VV</b>	150/0.20	1ph	280 ÷ 750	210	210	155	290	-	3	270x340x370	4
<b>Apollo con Leva</b>	150/0.20	1ph	320	210	265	155	330	480	3.5	270x340x370	4.5
<b>Apollo con Leva VV</b>	150/0.20	1ph	280 ÷ 750	210	265	155	330	480	3.5	270x340x370	4.5



APOLLO ECO

APOLLO



APOLLO CON LEVA VV



Setaccio con 2 pigne  
Sieve with 2 reamers



Pigna piccola e grande  
Small and big reamer





# MERCURIO

## spremiagrumi citrus juicers



MERCURIO CON LEVA

- Imponente e prestante, adatto a grossi carichi di lavoro.
- Struttura in alluminio anodizzato.
- Vasca e leva in acciaio inox Aisi 304.
- Potente motore ventilato con riduzione ad ingranaggi.
- Setaccio mobile con due dimensioni di pigna per adattarsi a tutti i tipi di agrume.
- Microinterruttore su pigna di serie.
- Variatore di velocità opzionale.
- Pratico sottobicchiere salvagoccia.
- *Imposing, efficient, heavy-duty juicer.*
- *Anodized aluminium frame.*
- *AISI 304 stainless steel bowl and lever.*
- *Powerful ventilated motor with gear drive.*
- *Removable sieve with reamer in two sizes to squeeze any kind of citrus.*
- *Standard microswitch on the reamer.*
- *Optional speed control.*
- *Practical mat.*



P. 228

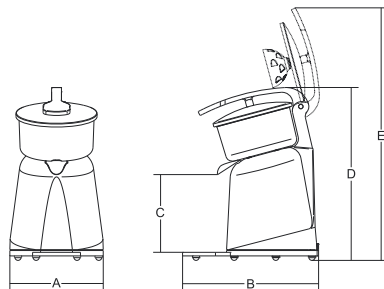

	watt/HP	r.p.m.	r.p.m.	mm	mm	mm	mm	mm	kg	mm	kg
Mercurio	150/0.20	1ph	320	210	300	173	355	-	5	390x300x440	6
Mercurio VV	150/0.20	1ph	280+750	210	300	173	355	-	5	390x300x440	6
Mercurio con Leva	150/0.20	1ph	320	210	300	173	385	570	6	390x300x440	7
Mercurio con Leva VV	150/0.20	1ph	280+750	210	300	173	385	570	6	390x300x440	7



Setaccio con 2 pigne  
Sieve with 2 reamers



Pigna piccola e grande  
Small and big reamer



MERCURIO



# TRITON

## tritaggiaccio ice crushers



- Permette di ottenere il ghiaccio tritato in varie dimensioni con una semplice regolazione del coltello:
- Ghiaccio sminuzzato finemente per le tradizionali granite.
- Ghiaccio in dimensioni più grandi per la preparazione di cocktail o per guarnire piatti freddi di portata o esposizione.
- Micro di sicurezza sulla bocca di carico.
- Micro di sicurezza sulla vaschetta di raccolta del ghiaccio.
- Bocca in alluminio brillantato.
- Componenti e minuterie in acciaio inox.
- Struttura portante in alluminio e acciaio.
- Mantello e vaschetta di raccolta in materiale plastico termoformato alimentare.
- Cinghia multirighe a basso assorbimento di potenza.
- *Allows to crush ice in different sizes by adjusting the blade:*
- *Finely crushed ice for the traditional Italian granitas.*
- *Flakes for frozen cocktails or to serve or display cold dishes.*
- *Safety microswitch on the feeding mouth.*
- *Safety microswitch on the collecting tray.*
- *Polished aluminium feeding mouth.*
- *Stainless steel parts and details.*
- *Aluminium and stainless steel internal structure.*
- *Body and tray are made from thermoformed alimentary plastic.*
- *Ribbed belt for low power absorption.*



Manopola per la regolazione dello spessore di taglio  
*Cut thickness adjusting knob*



Micro su leva  
*Microswitch on the lever*



Vaschetta con micro  
*Collecting tray with microswitch*

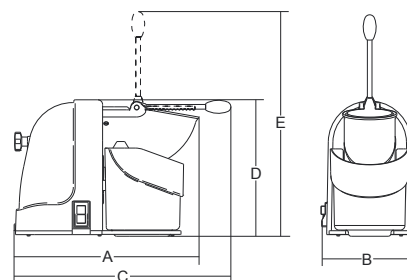

	watt	r.p.m.	r.p.m.	mm	lt	mm	mm	mm	mm	mm	kg	mm	kg	
<b>Triton</b>	350	1ph	12.000	1.500	10	2	365	210	465	295	480	8.5	540x280x310	10



# NORDKAPP

## tritaggiaccio ice crushers



- Spacca ghiaccio professionale, strumento indispensabile nel bar per la preparazione di drink e frozen, e nel ristorante per l'esposizione di pesce o pietanze fresche.
  - Riduce in scaglie qualsiasi cubetto di ghiaccio prodotto da fabbricatore fino ad una misura di mm 40x40 a -3°C.
  - Previsto di regolazione sullo scarico, permette di gestire la grandezza media delle scaglie
  - Corpo macchina in alluminio estruso, bicchiere in acciaio inox, bocca di lavorazione in ABS alimentare e coltelli ghiaccio in acciaio.
  - Motore ventilato con trasmissione ad ingranaggi, per un servizio prolungato, micro interruttore sul coperchio per la massima sicurezza dell'operatore.
- Professional ice crusher, an indispensable bar tool for preparing drinks and frozen cocktails and in the restaurant for displaying fish or fresh foods.
  - Crushes any ice cubes made with an ice cube machine up to 40x40mm at -3° C.
  - Its discharge adjustment lets you regulate the average size of the crushed ice.
  - Extruded aluminium body, stainless steel container, food-grade ABS opening and s/steel blades.
  - Ventilated motor with gear transmission for prolonged use, micro-switch on the lid for maximum operator safety.



Leva per la regolazione dello spessore del ghiaccio  
Adjustable lever ice thickness



Coltelli  
Blades

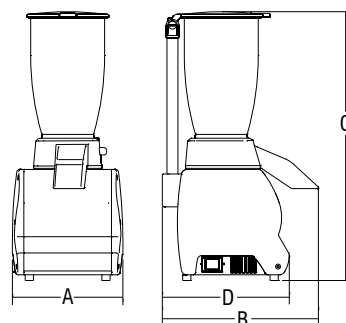

	watt	1ph	r.p.m.	lt	lt	mm	mm	mm	mm	kg	mm	kg
<b>Nordkapp</b>	150	1ph	800	3	2	205	285	491	235	5.2	410x280x560	8





# MODULO



## gruppi bar modulari modular bar groups

- Corpo macchina in alluminio estruso e fianchi in ABS.
- Potenti motori con ventilazione forzata.
- Frullatore, frappé, rompighiaccio e spremiagrumi mantengono le caratteristiche tecniche e originali della macchina singola.

AL = spremiagrumi con leva  
OQ = frullatore con bicchiere Quadro  
N = rompighiaccio  
S = frappé

- *Extruded aluminium machine body and sides in ABS.*
- *Powerful motor with forced ventilation.*
- *Blender, drink mixer, ice crusher and citrus juicer have the same technical and original features as the individual machines.*

AL = citrus juicers with lever  
OQ = blender with square glass  
N = ice crushers  
S = drink mixers



MODULO 1 AL



MODULO 2 ALOQ



MODULO 2 ALN



MODULO 2 OQN



MODULO 3 ALOQN



MODULO 4 ALOQNS



Setaccio con 2 pigne  
Sieve with 2 reamers









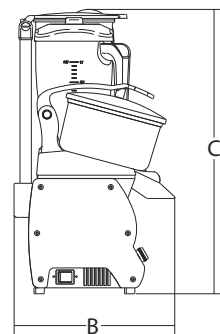
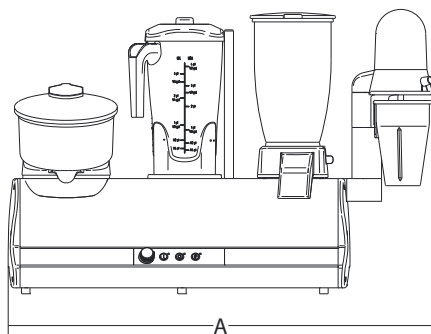

Bicchieri facilmente smontabili per la pulizia  
Disassembled glasses for cleaning



Bicchieri quadrati impilabili  
Stackable square glass



									
	watt/HP	ph	r.p.m.	mm	mm	mm	kg	mm	kg
<b>Modulo 1 AL</b>	150	1ph	320	202	242	370	4.2	290x380x395	6
<b>Modulo 2 ALOQ</b>	150/750	1ph	320/8.000 ÷ 16.000	402	242	486	9.2	380x500x590	11
<b>Modulo 2 ALN</b>	150/150	1ph	320/800	402	283	495	9.5	380x500x590	11.5
<b>Modulo 2 OQN</b>	750/150	1ph	8.000 ÷ 16.000/800	402	283	495	10.2	380x500x590	12
<b>Modulo 3 ALOQN</b>	150/750/150	1ph	320/8.000 ÷ 16.000/800	602	283	495	13.7	380x705x590	16
<b>Modulo 4 ALOQNS</b>	150/750/150/100	1ph	320/8.000 ÷ 16.000/800/14.000	747	283	501	16.5	380x840x590	18.5





# MULTIPLIO







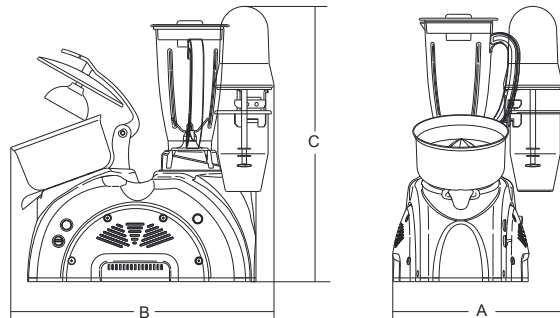

## gruppi bar bar groups

- Macchina a più servizi:
  - frappè, spremiagrumi e frullatore.
  - Motori appositamente dedicati ad ogni servizio specifico.
  - Coperture laterali che garantiscono una ottima ventilazione.
  - Facile movimentazione della macchina.
  - Facile accesso alle parti elettriche, smontando le coperture laterali, in caso di manutenzione.
- *Multipurpose combi machine:*
  - *drink mixer, citrus juicer, blender.*
  - *Separate motors for each function.*
  - *Side covers allow for a perfect ventilation.*
  - *Easy to carry.*
  - *Electrical parts are easily accessible for maintenance.*



MULTIPLIO 3S/L



									
	watt/Hp		r.p.m.	mm	mm	mm	kg	mm	kg
<b>Multiplo 2S</b>	450/150	1ph	16.000/320	252	445	495	6.5	380x600x600	8
<b>Multiplo 2S/L</b>	450/150	1ph	16.000/320	252	445	495	7.5	380x600x600	9
<b>Multiplo 3S</b>	450/150/100	1ph	16.000/320/14.000	317	490	510	9	380x600x600	10.5
<b>Multiplo 3S/L</b>	450/150/100	1ph	16.000/320/14.000	317	490	510	9.5	380x600x600	11
<b>Multiplo 4S</b>	450/150/100/100	1ph	16.000/320/14.000/14.000	382	490	510	10.5	580x600x600	12
<b>Multiplo 4S/L</b>	450/150/100/100	1ph	16.000/320/14.000/14.000	382	490	510	11	580x600x600	12.5



MULTIPLIO 2S



MULTIPLIO 2S/L



MULTIPLIO 3S

# ICE SPAGHETTI - SPREMIAGRUMI MANUALE



ICE SPAGHETTI

## ice spaghetti - spremiagrumi ice spaghetti - citrus juice

- Apparecchi con struttura in alluminio e cremagliera cromata, sono caratterizzati da un design lineare ed un funzionamento semplice. Entrambi sono dotati di particolari completamente smontabili per una pulizia più veloce ed accurata.
- Ice spaghetti: con tre diversi bicchieri in alluminio lucidato, si possono realizzare coppe curate nei minimi particolari.
- Spremiagrumi manuale: con pigna, imbuto e coperchio in acciaio inox 304, permette di spremere gli agrumi con una semplice pressione della leva.
- *With their aluminium construction and chrome rack, they feature a simple design and are easy to use. Both can be disassembled for a quicker and more accurate cleaning.*
- *Ice Spaghetti: with three different polished aluminium moulds, you can create elaborate ice-cream cups.*
- *Manual squeezer: 304 stainless steel cone, funnel and lid, it allows to squeeze citrus by simply pressing the lever.*

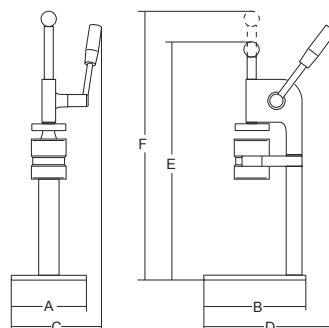

		A	B	C	D	E	F			
	mm	mm	mm	mm	mm	mm	mm	kg	mm	kg
Ice Spaghetti	65x80	170	200	205	245	440	520	3.5	520x220x230	4
Spremiagrumi Manuale	-	170	200	205	245	440	520	3.5	520x220x230	4



SPREMIAGRUMI MANUALE

1. Spaghetti ø mm 2,5
2. Tagliatelle mm 8x2
3. Asparagi ø mm 15,5

1. Spaghetti ø mm 2,5
2. Noodles mm 8x2
3. Asparagus mm ø 15,5





## DISTRIBUZIONE ESCLUSIVA

Da oltre 45 anni azienda leader nel settore delle attrezzature per i professionisti della cucina, Sirman si è sempre distinta nel mercato per la grande attenzione rivolta alle innovazioni della tecnica nel settore della ristorazione.

Proprio per questo all'interno della sua vasta gamma di produzione, trovano spazio nomi di spicco dell'alta tecnologia - come i forni a microonde Panasonic, le affettatrici Scharfen, il rivoluzionario Pacojet e altri gioielli della tecnica applicata all'arte di cucinare - che Sirman distribuisce in esclusiva per l'Italia dopo averli testati in collaborazione con i migliori tecnici e i più affermati chef del momento.

## EXCLUSIVE DISTRIBUTION

*A leader in the professional kitchen equipment sector for over 45 years, Sirman has always been outstanding because of the great attention it has always paid to technical innovation in the restaurant business.*

*For this precise reason within the huge range of proposals the famous names of high technology can be found - like the Panasonic microwave ovens, Scharfen slicers, the revolutionary Pacojet and other valuable technological gems applied to the art of cooking - of which Sirman is the exclusive distributor in Italy, after having tested them in collaboration with the best technicians and the best known chefs of the moment.*







# SCHARFEN

affettatrici  
slicing machines



VA 4000

- La VA 4000 è un'affettatrice completamente automatica, pratica ed affidabile.
- Le eccezionali caratteristiche tecniche permettono di ottenere un'ordinata disposizione della merce. È facilmente programmabile per altissimi rendimenti, conseguiti tramite la moderna tecnologia che sta alla base della fabbricazione.
- La VA 4000 è caratterizzata da un utilizzo economicamente vantaggioso: grandi quantità di prodotto vengono affettate e porzionate.
- La lavorazione è sempre igienica ed accurata: le fette possono avere un diametro minimo di 50mm e massimo di 200.
- Le punte del pressamerce permettono un fissaggio ottimale del prodotto da tagliare; il carro, inoltre, dà la possibilità di ottenere un taglio comodo e razionale, che permette di risparmiare tempo e fatica.
- L'affettatrice è dotata di uno sgancio carrello per l'uso manuale.
- La base della macchina è saldata e gli spigoli sono arrotondati, in modo da permettere una pulizia facile e rapida.
- Le diverse funzioni sono rappresentate simbolicamente sulla pulsantiera comandi e riprodotte sul display della stessa.

#### CARATTERISTICHE DI RESA

- 25-55 fette al minuto.
- 99 memorie, con possibilità di definire spessore di taglio, modo di disposizione delle fette e velocità di carrello.
- Telaio a catena con capacità di portata da un minimo di 50 mm fino a un massimo di 200 mm.
- Lama mossa da trasmissione ad ingranaggi che assicura una perfetta resa anche nei lavori continui.







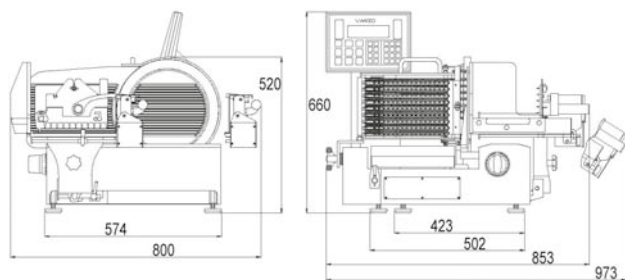





- The VA 4000 is a reliable, handy, completely automatic slicing machine.
- Its exceptional technical features allow to get an orderly stacking of slices. It is easily programmable for high output thanks to the modern technology that lies at the heart of its manufacturing.
- The VA 4000 features an economically profitable use: large quantities of product are sliced and proportioned.
- Processing is always hygienic and accurate: slices can have a diameter from 50 to 200 mm maximum.
- The gripping points of the meat press allow a perfect fixing of the product to be cut; besides, the hopper makes possible an easy and functional cutting, thus saving time and effort.
- Possibility to manual use
- The base of the machine is welded and round-edged for easy and quick cleaning.
- Different functions are symbolized on the control panel and shown on the display.

#### OUTPUT FEATURES

- 25-55 slices per minute.
- 99 memories with the possibility to pre-set cut thickness, the way of stacking slices and carriage speed.
- Chain loom which handles slices from 50 mm up to a maximum of 200 mm diameter.
- Gear driven blade to assure a perfect output also in continuing operations.



VA 4000 AT

													
	watt		mm	mm	mm	mm	mm	mm	mm	mm	kg	mm	kg
VA 4000	600	3ph+N	330	10	255x195	-	360x275	530x275	360x275	800x973 h.660	80	1140x840x840	108
VA 4000 AT	600	3ph+N	330	10	255x195	880x220	-	530x275	360x275	1320x973 h.1330	90	1140x840x840	118
Cavalletto/Trestle	-	-	-	-	-	-	-	-	-	-	30	740x830x960	38



# MINNEAPOLIS

## bilance scales

### MINNEAPOLIS 10/2 - 20/5 - 40/10 INOX

- Bilance digitali portatili da cucina o per lavori di precisione..
- Costruita in acciaio inox.
- Ampio display digitale retroilluminato.
- Alimentazione a batteria ricaricabile.
- Unità di pesata g, lb e oz.
- Porta seriale per collegamento dati.
- Trasformatore caricabatteria incluso.

### MINNEAPOLIS 20/2-5

- divisione 2 gr. fino a 4 kg
- divisione 5 gr. da 4 kg a 20 kg.

### MINNEAPOLIS 40/5-10

- divisione 5 gr. fino a 8 kg
- divisione 10 gr. da 8 kg a 40 kg.

### MINNEAPOLIS 30/1

- Bilance digitali portatili da cucina o per lavori di precisione..
- Piano appoggia merce in acciaio inox.
- Ampio display digitale retroilluminato.
- Alimentazione a batteria ricaricabile.
- Funzionalità contapezzi.
- Massima pesata 30 Kg divisione 1 g.
- Trasformatore caricabatteria incluso.

**Attenzione! Bilance per solo uso di laboratorio, non sono omologate per la vendita al dettaglio.**



MINNEAPOLIS 10/2 - 20/5 - 40/10 INOX

### MINNEAPOLIS 10/2 - 20/5 - 40/10 INOX

- Digital portable scales for the kitchen or precision work.
- Made from stainless steel.
- Large digital back lit display.
- Powered by rechargeable batteries.
- g, lb,oz weighin unit.
- Serial port for data transfer
- Battery loading transformer included.

### MINNEAPOLIS 20/2-5

- precision 2 gr. until 4 kg
- precision 5 gr. from 4 kg to 20 kg.

### MINNEAPOLIS 40/5-10

- precision 5 gr. until 8 kg
- precision 10 gr. from 8 kg to 40 kg.

### MINNEAPOLIS 30/1

- Digital portable scales for the kitchen or precision work.
- Stainless steel tray.
- Large digital back lit display.
- Powered by rechargeable batteries.
- Piece counter option.
- Max weight 30 Kg division 1 g.
- Battery loading transformer included.

**Warning! Scales for internal use not approved for sale.**



MINNEAPOLIS 30/1

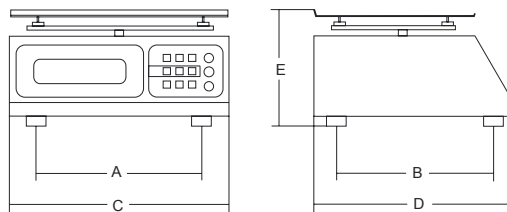

				A	B	C	D	E			
	watt/l/hp	g	mm	mm	mm	mm	mm	mm	kg	mm	kg
Minneapolis 10/2 Inox	10	2	240x180	160	160	248	253	132	3.5	320x320x190	4.5
Minneapolis 20/2-5 Inox	20	2-5	240x180	160	160	248	253	132	3.5	320x320x190	4.5
Minneapolis 40/5-10 Inox	40	5-10	240x180	160	160	248	253	132	3.5	320x320x190	4.5
Minneapolis 30/1	30	1	255x185	190	172	255	300	110	3.8	310x355x145	4.5



# MINNEAPOLIS

## bilance scales



**MINNEAPOLIS 5/1 FLAT INOX**

**MINNEAPOLIS 5/1 FLAT INOX**

- Easy to carry scales suitable for precision work and for the kitchen.
- Stainless steel tray.
- Large digital backlight display.
- Battery low indication.
- Overload indication.
- Without operation, the scale will switch to clock mode automatically in 60 seconds.
- g, lb, oz weighin unit.

**MINNEAPOLIS 5/1 - 5/1 INOX**

- Easy to carry scales suitable for precision work and for the kitchen.
- S/S body and glass top; S/S container on the model "INOX".
- Digital display.
- Battery low indication.
- Over and under weight indicator.
- Autoswitch-off after 20 seconds inactivity (only battery operated).
- g, lb, oz weighin unit.

**Warning! Scales for internal use not approved for sale.**

**MINNEAPOLIS 5/1 FLAT INOX**

- Bilance portatili da cucina o per lavori di precisione.
- Piano appoggia merce in acciaio inox
- Ampio display led retroilluminato.
- Indicatore di batteria scarica.
- Indicatore di sovrappesata.
- Dopo 60 secondi di inattività passa automaticamente in modalità orologio.
- Unità di pesata g, lb e oz.

**MINNEAPOLIS 5/1 - 5/1 INOX**

- Bilance portatili da cucina o per lavori di precisione.
- Corpo in acciaio inox e piano di pesata in vetro o contenitore in acciaio per il modello inox.
- Display digitale.
- Indicatore di batteria scarica.
- Indicatore di sovra-sotto portata.
- Autospegnimento dopo 20 secondi di inattività (solo con l'utilizzo delle batterie).
- Unità di pesata g, lb e oz.

**Attenzione! Bilance per solo uso di laboratorio, non sono omologate per la vendita al dettaglio.**

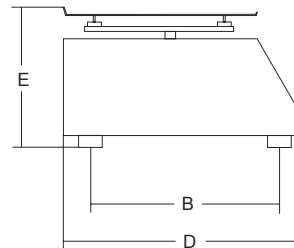
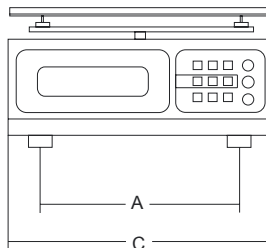

	watt/Hzp	g	mm	mm	mm	mm	mm	mm	kg	mm	kg
<b>Minneapolis 5/1 Flat Inox</b>	5	1	186x217	-	-	186	217	16	0.5	230x200x30	1
<b>Minneapolis 5/1</b>	5	1	∅150	180	220	230	190	50	1	180x270x230	1.5
<b>Minneapolis 5/1 Inox</b>	5	1	200xh.60	180	220	230	190	105	0.8	240x215x135	1



**MINNEAPOLIS 5/1 INOX**

**MINNEAPOLIS 5/1**



# PACOJET

pacojet



PACOJET II



PACOJET II - LIMITED ED.

Sempre attenta alle nuove tendenze del mercato e alle esigenze della sua clientela, Sirman presenta - in esclusiva per l'Italia - PACOJET: un capolavoro della tecnica, una novità mondiale e, soprattutto, un indispensabile e insostituibile strumento di lavoro per i migliori Professionisti della Ristorazione. Costruito in pregiato materiale con un alloggiamento in nichel-cromo, estremamente compatto, Pacojet- grazie ad una tecnica nuova e unica nel suo genere - assolve ad un compito fondamentale nelle cucine di alta qualità: "pacossare" i generi alimentari.

Oververo: tritare, trasformare in pure, mousse e patè, generi alimentari diversi, mantecare ed emulsionare sorbetti e gelati da base surgelata.

Il tutto in un'unica e sola operazione!

Con Pacojet, infatti, avrete la possibilità, in pochissimo tempo, di avere il prodotto finito e pronto per essere consumato passando quasi direttamente dal conservatore al piatto di portata. Il segreto sta tutto nell'eliminazione dei tempi di scongelamento che influiscono sui ritmi di lavoro.

In tal modo viene offerta l'opportunità di preparare in anticipo ingredienti di diversa tipologia utilizzandoli all'occorrenza subito e nelle quantità desiderate. Inoltre, data la rapida lavorazione, le porzioni in eccesso potranno essere reinserite nella catena del freddo prima che l'azione dello scongelamento possa danneggiarle.

## PACOJET II / PACOJET II LIMITED EDITION

- Dotato di motore brushless, a basso consumo, sviluppa una maggiore forza con un livello di rumorosità decisamente inferiore rispetto a Pacojet Junior.
- Gestisce il bicchiere con 10 porzioni e decimi di ogni singola porzione.
- Lavora con 2 velocità in modo da rendere più efficiente l'avvicinamento del coltello al prodotto da lavorare ed il ritorno in posizione.
- Dispone di porta USB per la diagnostica.
- Display grafico semplice ed intuitivo per la gestione dei vari programmi: lavorazione gelo, lavorazione fresco e pulizia.

*Ever attentive to the latest market trends and the needs of its customers, Sirman presents - exclusively for Italy - the PACOJET: a masterpiece of technique, a worldwide new release and, above all, an essential and irreplaceable tool for the leading professionals in the restaurant industry.*

*Manufactured using quality materials, with a nickel-chrome fitting, and extremely compact, Pacojet - thanks to a new technique, unique in its class - performs a fundamental task in quality kitchens: the "pacotizin" of foods.*

*That is: chopping, mashing, making mousses and pâtés using different foods, whipping and emulsifying sorbets and ice cream from frozen ingredients. All in just one operation!*

*With Pacojet, in fact, you will be able, in a very short time, to create a finished and ready-to-consume dishes, passing almost directly from the freezer to the serving plate. The secret lies in the elimination of defrosting times, which affect working time.*

*This allows different types of ingredients to be prepared in advance, and then used immediately when required and in the desired proportions.*

*In addition, given the rapid processing speed, the excess portions can be returned to cold storage before being damaged by defrosting.*

## PACOJET II / PACOJET II LIMITED EDITION

- Equipped with a low-consumption brushless motor, it develops greater power with a decidedly lower noise level compared to Pacojet Junior.
- It manages the cup with 10 portions and tenths of each single portion.
- It has 2 speeds to enhance the knife's efficiency when approaching the product to be processed and returning to its initial position.
- It features a USB port for diagnostics.
- Straightforward and intuitive graphic display for managing the various programmes: frozen processing, fresh processing and cleaning.



**PACOJET JUNIOR**



Creatività e ampia possibilità d'utilizzo  
Creativity and a vast range of possible uses



Il contenitore ideale  
The ideal container



Un passaggio nell'abbattitore e poi...  
Into the blast chiller and then...



...tutto nel congelatore!  
...all in the freezer!



Pronto da pacossare  
Ready to be "pacotize"



Da 1 a 10 porzioni di sapore  
From 1 to 10 portions of flavour









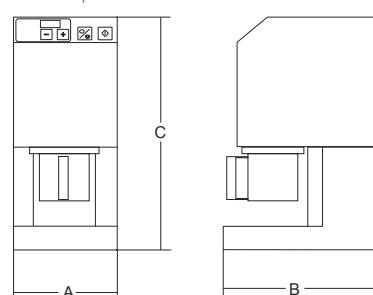





Contenitore isotermico 4 bicchieri opzionale  
Optional isolated 4 beaker box



Kit di lame per alimenti freschi opzionale  
Optional set of knives for fresh food



												
	watt	1ph	r.p.m.	bar	lt	°C	mm	mm	mm	kg	mm	kg
<b>Pacojet Junior</b>	1.000	1ph	2.000	1	0.8	-18 ÷ -23°C	182	360	498	13	300x600x460	16
<b>Pacojet II</b>	950	1ph	2.000	1.2	0.8	-18 ÷ -22°C	200	360	500	15.7	300x600x460	19
<b>Pacojet II - Limited Ed.</b>	950	1ph	2.000	1.2	0.8	-18 ÷ -22°C	200	360	500	15.7	300x600x460	19



# IH 27 - IH 35 - IH 35 WOK - PI5.0 KW

## piastre ad induzione induction hobs

- Facilmente installabili in qualsiasi piano liscio presente in cucina, nei ristoranti e nelle sale da pranzo come dimostrazione, o la preparazione di piatti particolari di fronte ai clienti, grazie all'assenza di fumi e odori.
  - Dotate di pulsantiera digitale graduata.
  - Estremamente facili da utilizzare e da pulire.
  - Superficie di cottura pratica da pulire.
  - Massima sicurezza grazie alla superficie di cottura che non si riscalda.
  - Risparmio energetico grazie alla velocità di riscaldamento e all'elevata resa.
  - Non sono previsti tempi di pre-riscaldamento ed il consumo di energia si blocca non appena la pentola viene rimossa dal piano.
- The induction hobs are easy to install on every working surface in kitchens, restaurants or dining rooms; thanks to the absence of fumes they are perfect for public cooking performances or when the preparation is made in view of customers.*
- Graduated digital controls.
  - Extremely easy to use and to clean.
  - Cooking surface makes cleaning easy.
  - Safe operations are ensured by the cooking surface which is never heating up.
  - Induction hobs are energy saving thanks to heating efficiency and no need to heat up.
  - Electric absorption is stopped when the pan is removed from the hob surface.



PI 5.0 KW

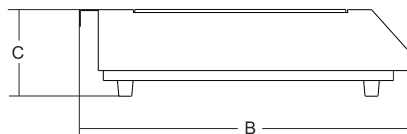
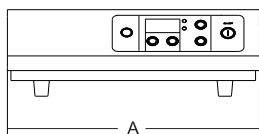

				A	B	C			
	watt		mm	mm	mm	mm	kg	mm	kg
IH 27	2.700	1ph	280x280	323	370	105	4	360x425x130	4.5
IH 35	3.500	1ph	280x280	330	425	105	5	385x475x145	5.5
IH 35 Wok	3.500	1ph	ø280	340	445	110	7.3	410x505x160	8
PI 5.0 Kw	5.000	3ph	320x320	320	495	135	8.8	570x400x320	12



IH 27



IH 35 WOK



IH 35





# PB 1/1 INOX



## piastra buffet buffet plate



PB 1/1 INOX

- Ottimo sostituto del Bagnomaria per il mantenimento in temperatura di teglie e pirofile in metallo, vetro e porcellana.
  - Pratica piastra riscaldante da buffet.
  - Robusta struttura in acciaio inox satinato.
  - Pratiche maniglie inox per una facile movimentazione anche quando calda.
  - Regolatore di temperatura da 0 a 90 °C.
  - Vetro di appoggio temperato.
  - Dimensioni vetro compatibili con GN1/1.
- *Bain - marie alternative for maintaining the temperature of trays and casserole dishes made of metal, glass and porcelain.*
  - *Hot Plate conveniently designed for buffet and table service.*
  - *Sturdy polished stainless steel frame.*
  - *Convenient handles to easily carry it.*
  - *Dial temperature control up to 90 °C (194 °F).*
  - *Tempered glass.*
  - *Glass dimensions Gastronorm 1/1.*

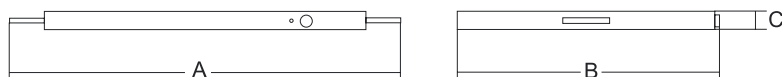

	watt		°C	mm	mm	mm	mm	kg	mm	kg
PB 1/1 Inox	230	1ph	0 ÷ 90	530x325	610	370	45	4,5	665x400x175 (n.2 PB 1/1 inox)	10



# SR-UH36N

**Panasonic**  
MICROONDE

## cuoceriso rice cooker

Veloci e pratiche, offrono risultati eccellenti in poco tempo, a cottura terminata il riso può rimanere per diverse ore nel cuoceriso in modalità di mantenimento temperatura.

La pentola interna in materiale antiaderente è asportabile per la pulizia. Il coperchio è facilmente apribile e sono pratiche da maneggiare grazie alla loro conformazione. Ideali per hot buffets, pub, self service, mense, ristoranti e take aways.

*Easy-to-use rice cookers that give you excellent result in a few minutes. With machine set on "keep warm", cooked rice can remain inside the cooking pan for several hours.*

*The non stick pan is removal for cleaning. The lid can be easily opened. Both are designed to be easy to handle and move around the kitchen. The rice cookers are perfect for hot buffets, pubs, traditional and self service restaurants, canteens and take-aways.*

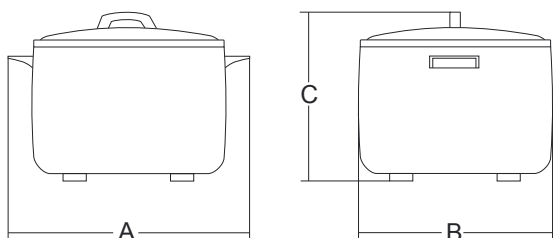

	watt	°C	mm	mm	mm	mm	mm	kg	mm	kg
<b>SR-UH36N</b>	Cottura Mantenimento temperatura 1400 124	3.6	20	12	430	385	350	8	430x430x400	9





## forni a microonde microwave oven



- Forno combinato, perfetto complemento per qualsiasi esigenza grazie alle 3 diverse modalità di impostazioni: microonde, grill e convezione.
- La funzione grill, ottenuta con tubi al quarzo, grazie ai tre livelli di potenza, permette la rosolatura di numerosi tipi di piatti.
- La combinazione tra microonde e grill rende il forno versatile anche per la realizzazione di cotture complete.
- *Combined oven, the ideal accessory for all your needs, thanks to 3 different setting modes: microwave, grill and convection.*
- *The grill function, obtained with quartz pipes, thanks to the three power levels, allows you to brown a variety of dishes.*
- *The microwave-grill combination makes the oven versatile, to also perform complete cooking.*

	max
	alta high
	media medium
	scongelamento defrost
	bassa low
	mantenimento keep warm

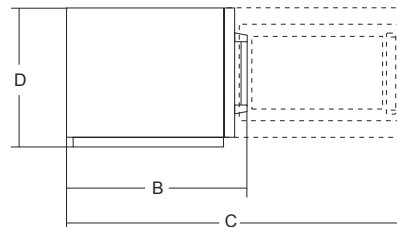
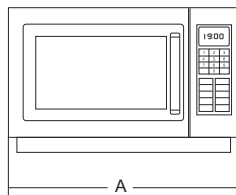

	watt	watt	watt	watt	min.	lt	mm	mm	mm	mm	kg	kg	
NN CF771S	max 2.700 microw. 850 grill 1.300 conv. 1.450	microw. 1.000 grill 1.270 conv. 1400	1.000 600 440 270 250 100	1.270 950 700	90	27	354x343 h.205	529	494	885	326	20	23



# NE 1027-1037-1037 SELF



## forni a microonde microwave oven

Forni dotati di un sistema di propagazione delle microonde dal basso verso l'alto che permette uniformità e celerità di cottura. Dimensioni camera 1/2 gastronorm. Involucro esterno e camera di cottura in acciaio inossidabile per una pulitura facile e rapida. Piatto di cottura perfettamente piano in vetroceramica.

### NE 1027

- Pratico selettore di potenza a 6 posizioni per cuocere, riportare in temperatura, scongelare, completamente e velocemente.

### NE 1037

- 10 programmi fissi automatici, cioè modi e tempi di funzionamento che possono venire memorizzati individualmente. Possono venire richiamati fino a 20 diversi programmi automatici a piacere.
- Tasto (x2): con l'azionamento del tasto il tempo d'impiego viene raddoppiato.

### NE 1037 SELF

- Due programmi pre-regolati per porzione grande (50 sec.) e porzione piccola (30 sec.); ideale per riscaldare velocemente pasti già pronti.



NE1037

*Compact, high-powered ovens: the microwave propagation system from below upwards enables a quick and uniform cooking. Cavity dimensions of 1/2 Gastronorm. Covering and cavity are made of stainless steel for a quick and easy cleaning. Completely flat cooking plate in ceramic glass.*

### NE 1027

- Practical power selector switch with 6 positions for cooking, heating, defrosting completely and quickly.

### NE 1037

- 10 automatic pre-set programs, that is, way and time of cooking can be stored separately.
- Key (x2): by pressing it, the working time is doubled.

### NE 1037 SELF

- two programs pre-regulated for big portion (50 sec.) and small portion (30 sec.) ideal for quickly warming of already prepared food.

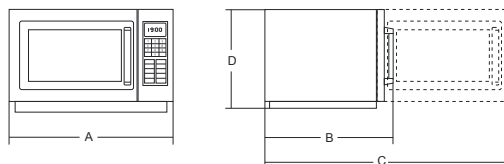

	watt	watt	watt	watt	min.	lt	mm	mm	mm	mm	kg	
<b>NE1027</b>	1ph 1.490	1.000	1x1.000W	variable	30	22	330x330x200	510	360	745	306	18
<b>NE1037</b>	1ph 1.490	1.000	1x1.000W	1.000/500	90	22	330x330x200	510	360	745	306	18
<b>NE 1037 Self</b>	1ph 1.490	1.000	1x1.000W	1.000/500	30-50	22	330x330x200	510	360	745	306	18



NE1027



NE 1037 SELF

# 1/1 GASTRONORM



NE1880

## forni a microonde microwave oven

### NE 1840-2140-3240

- Capienti e spaziosi, sono in grado di contenere 2 taglie Gastronorm sui due piani. Funzionamento sia su di un piano che su due, grazie al ripiano in vetroceramica e ai 4 magnetron.
- Apertura della porta verso il basso che diventa quindi un saldo piano di appoggio.
- Ideali per ristoranti, trattorie, mense, hotel e in genere per grandi cucine.

### NE 1880

- Forno Gastronorm digitale, dotato di 16 tasti memoria completamente programmabili con 4 livelli di potenza.
- Regolazione del segnale acustico, contacicli di cottura.
- Lavora con 4 livelli di potenza, sia a mezzo dei tasti memoria che a mezzo timer manuale di 45 minuti sui due piani.
- Adatto per tutte le applicazioni della grande ristorazione e catering.

### NE 1840-2140-3240

- Large and spacious, capable of containing two Gastronorm trays on two shelves. Designed for cooking in one or two layers, thanks to the glass-ceramic shelves, provided as a standard fitting, and the four magnetrons.
- The door opens downwards and becomes a sturdy shelf. Practical and sturdy steel handles for an easy grip.
- Ideal for restaurants, pubs, canteens, hotels and professional kitchens in general.

### NE 1880

- Gastronorm digital oven, complete with 16 fully-programmable memories with four cooking levels, i.e.
- 4 different power levels.
- Adjustable acoustic signal, cooking cycles counter. Works on four power levels, using either the memory buttons or the 45-minute manual timer, and on two shelves.
- Suitable for all applications in professional restaurant and catering services.

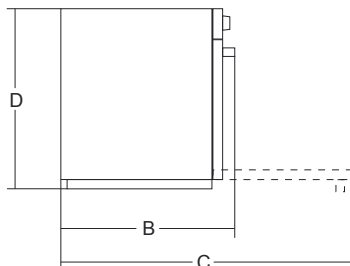
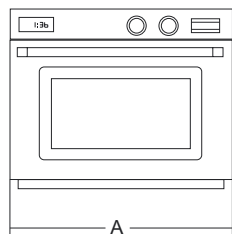

		watt	watt	Mhz	n.	min.	lit	mm	mm	mm	mm	mm	mm	kg	kg
NE1840	1ph	3.200	1.800 / 900 / 340 / 170	2.450	4x450W	60 / 60 / 60 / 60	44	565x330 h.250	1 GN	650	526	850	471	54	58
NE1880	1ph	3.200	1.800 / 900 / 340 / 170	2.450	4x450W	15 / 15 / 60 / 60	44	565x330 h.250	1 GN	650	526	850	471	54	58
NE 2140	1ph	3.650	2.100 / 1.050 / 340 / 170	2.450	4x525W	60 / 60 / 60 / 60	44	565x330 h.250	1 GN	650	526	850	471	54	58
NE 3240	3ph	4.960	3.200 / 1.600 / 340 / 170	2.450	4x800W	60 / 60 / 60 / 60	44	565x330 h.250	1 GN	650	526	850	471	54	58



NE1840



NE 2140 - NE 3240

- alta  
high
- media  
medium
- scongelamento  
defrost
- bassa  
low



# 1/2 GASTRONORM

forni a microonde  
microwave oven



NE 2153-2

## NE 1643 / 1843 / 2143-2

- Semplici, compatti e potenti questi tre forni si distinguono per la loro facilità d'impiego.
- Dotati di timer manuale da 30 minuti, tre livelli di potenza, tasto start e display luminoso. Apertura laterale della porta. Possono essere sovrapposti.
- Adatti per tutte le applicazioni, dallo snack al piccolo ristorante, ideali per bar e paninoteche.

## NE 1643 / 1843 / 2143-2

- *Straightforward and powerful, these three ovens stand out for their easy use.*
- *Complete with a 30-minute manual timer, three power levels, a start button and a luminous display. The door opens sideways.*
- *Suitable for stacking. Ideal for all applications, from the snack bar to the small restaurant, perfect for pubs and sandwich bars.*

## NE 1653 / 2153-2

- Forni digitali, si distinguono dai 3 modelli visti in precedenza per la possibilità di utilizzare 20 memorie pre-programmate.
- È possibile programmare i tasti memoria con 2 differenti fasi di cottura cioè 2 tempi e 2 potenze diverse (es. scongelamento-cottura).
- Funzione di "blocco-sblocco programma" per funzionamento solo con memorie o anche manuale.
- Regolazione intensità segnale acustico e contattici di cottura per forni a noleggio.
- Memorizzazione automatica dell'ultima cottura eseguita.
- Adatti soprattutto per fast-food, self-service, mense, piccoli e grandi snack.

## NE 1653 / 2153-2

- *Digital ovens, these differ from the three previous models in that they provide for 20 pre-programmed memories.*
- *You can program the memory buttons with two different cooking stages, i.e. 2 different times and 2 different power ratings (e.g. defrosting and cooking).*
- *The "program lock/release" function is for working with the memories alone or in combination with the manual mode.*
- *The intensity of the acoustic signal is adjustable and there is a cooking cycle counter for ovens that are for rental.*
- *The last cooking cycle performed is automatically memorized.*
- *Suitable especially for fast-food outlets and self-service restaurants, canteens, small and large snack bars.*



NE 1653



NE 1643 - NE 1843





# Panasonic

M I C R O O N D E

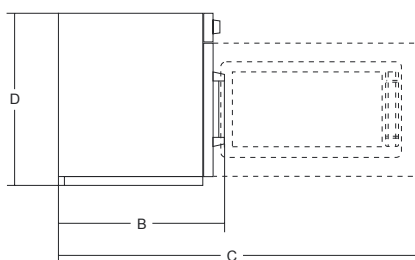
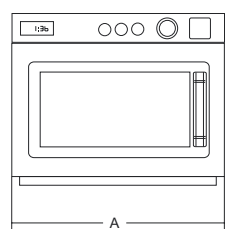

Secondo piano estraibile per i modelli NE 2143-2 e NE 2153-2  
Removable intermediate shelf for models NE 2143-2 e NE 2153-2



-  max
-  alta  
high
-  media  
medium
-  scongelamento  
defrost

		watt	watt	Mhz	n.	min.	lt	mm	mm	mm	mm	kg	kg	
NE 1643	1ph	2.590	1.600 / 800 / - / 340	2.450	2x800W	25 / 30 / - / 30	18	330x310 h.175 1/2 GN	442	508	905	337	30	33
NE 1843	1ph	2.830	1.800 / 900 / - / 340	2.450	2x900W	25 / 30 / - / 30	18	330x310 h.175 1/2 GN	422	508	905	337	30	33
NE 2143-2	1ph	3.160	2.100 / 1.050 / - / 340	2.450	2x1.050W	25 / 30 / - / 30	18	330x310 h.175 1/2 GN	422	508	905	337	30	33
NE 1653	1ph	2.590	1.600 / 800 / - / 340	2.450	2x800W	15 / 15 / - / 30	18	330x310 h.175 1/2 GN	422	508	905	337	30	33
NE 2153-2	1ph	3.160	2.100 / 1.050 / - / 340	2.450	2x1.050W	15 / 15 / - / 30	18	330x310 h.175 1/2 GN	422	508	905	337	30	33



# NE C 1475

forni a microonde  
microwave oven



- Il forno professionale combinato non è solo un forno in grado di assolvere in modo eccellente alle diverse funzioni di forno a microonde, forno a convezione e grill. È la possibilità di utilizzare questi diversi tipi di cottura separatamente, in sequenza o in combinazione, per realizzare qualsiasi piatto in tempi rapidi e con risultati ottimali.
- Proprio nell'uso combinato è il vantaggio più importante.
- Finalmente è possibile preparare cibi perfettamente dorati e gratinati, come quelli che si ottengono con la cucina tradizionale, risparmiando 1/3 del tempo di cottura.
- È ideale per gli snack, pub, bar e per tutte le situazioni in cui la disponibilità di spazio sia ridotta, perché assolve in modo eccellente le diverse funzioni con il minimo ingombro.
- Nelle cucine professionali sostituisce la salamandra e, nei momenti di minore attività, può essere usato come forno a convezione forzata al posto di forni con dimensioni più grandi e consumi maggiori.

#### MICROONDE:

- Due magnetron forniscono una potenza resa di 1350W

#### GRILL:

- la funzione GRILL viene realizzata con 4 tubi al quarzo regolabili con 3 livelli di potenza per garantire la massima versatilità.

#### CONVEZIONE:

- Una resistenza da 1800W abbinata ad una ventola garantisce un rapido riscaldamento della camera ed una uniformità di temperatura.

- *The Panasonic NE C1475 is far more than an excellent microwave oven, convection oven and grill all rolled into one. It lets you choose to use each cooking method separately, in sequence or in combination, to cook any type of dish in the shortest possible time and with the best possible results.*
- *The Panasonic NE C1475 really excels as a combination oven.*
- *With combination cooking, you can brown and crisp foods to get the same appetising results normally possible only with traditional cooking - but with a saving of 1/3 in cooking time.*
- *It is ideal for snack bars and all catering establishments where space saving is a prime consideration.*
- *It can easily replace the salamander in large catering kitchens, and during slack periods, can serve as a small convection fan oven in the place of bigger units with far higher energy consumption.*

#### MICROWAVES:

- two magnetron supply a 1350 W output power in 5 different levels.

#### GRILL:

- grill function assures highest versatility thanks to 4 quartz tubes with 3 power levels.

#### CONVECTION:

- a 1800W heating element assures a fast heating of the chamber and temperature uniformity.



# Panasonic

M I C R O O N D E



Convezione con Ventola e Resistenza posteriori. Questo forno combinato Vi offre una grande e potente convezione da 1800 W tramite l'efficacia di una resistenza e una ventola sistemate sul retro del forno stesso.

*Convection system with rear fan and elements The Panasonic NE - C1475 combination oven includes a powerful 1800 W convection cooking system with one heating element and fan on the rear wall.*

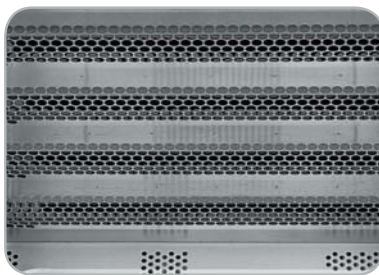





Questo forno combinato é dotato di un grill da 4 resistenze al quarzo per assicurare una doratura eccellente e velocissima.









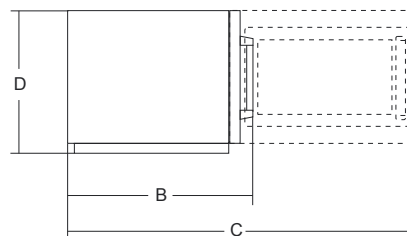
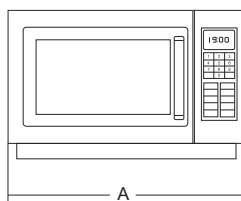



*This combination oven has a four quartz element grill for fast and even browning.*



Memory Card

-  alta  
high
-  media  
medium
-  scongelamento  
defrost
-  bassa  
low
-  cottura lenta  
simmer



								A	B	C	D	
	watt	watt	watt	watt	min.	lt	mm	mm	mm	mm	mm	kg
NE C1475	3.300	 3.350  650  420  180  240	1.800 1.450	1.800 (100-250°C)	99	30	406x336 h.217	600	545	930	383	41



# WDB 900 COMBI - WP 1000PF - CM1039A

forni a microonde  
microwave oven



WD B 900 COMBI



WP 100 PF M



CM 1039 A

- Interamente in acciaio inox.
- Piatto rotante in vetro temperato.
- Timer 30 min.
- Selettore a 6 livelli di potenza microonde.
- 2 combinazioni grill-microonde.
- Programma automatico scongelamento a peso.
- Ideale per la piccola ristorazione, bar e snack.

- *Stainless steel construction*
- *Tempered glass rotating plate*
- *Timer 30 min.*
- *Microwave: 6 different power levels*
- *2 grill-microwave combination*
- *Weight-based automatic defrost*
- *Ideal for small restaurants and bars*

- Potenza resa microonde 1000 Watt.
- 5 livelli di potenza per una massima versatilità.
- Comandi manuali per potenza e timer.
- Interno ed esterno in acciaio inox.
- Piatto fisso in vetroceramica.
- Apertura con pratica maniglia ed ampio vetro per controllo livello di cottura.

- *1000 Watt output induction power*
- *High versatility with 5 power levels*
- *Manual controls for power and timer*
- *Stainless steel cabinet and cavity finish*
- *Ceramic glass cooking plate*
- *See-through opening door with practical handle*

- Comandi manuali per potenza e timer.
- Interno ed esterno in acciaio inox.
- Piatto fisso in vetroceramica.
- 5 livelli di potenza per una massima versatilità.
- Apertura con maniglia ed ampio vetro per controllo livello di cottura.

- *Manual dial controls for power & timer*
- *Stainless steel cabinet and cavity finish*
- *Ceramic glass cooking plate*
- *High versatility with 5 power levels*
- *Pull to open door with large display window*

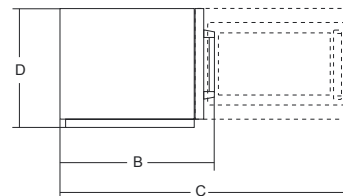
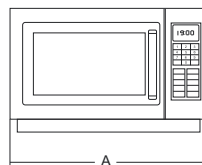

	1ph	watt	watt	Mhz	watt	lt	mm	mm	mm	mm	mm	kg	kg
<b>WD B 900 Combi</b>	1ph	1.400 microw. 1.000 grill	900	2.450	5	25	340x344 h.220	483	422	735	281	14.5	16.7
<b>WP 100 PF M</b>	1ph	1.500	1000	2.450	6	25	330x360 h.200	520	442	790	312	17.7	19.3
<b>CM 1039 A</b>	1ph	1.450	900	2.430	5	26	336x349 h.225	517	412	760	297	17.5	19.3



# 45K

## dispenser shrink wrappers



Ideati per il confezionamento di alimenti come carne, formaggio, pasta, frutta e verdura freschi; i dispenser offrono un servizio veloce e igienico nei supermercati, macellerie e gastronomie in genere, dove il commercio di prodotti freschi richiede un confezionamento giornaliero veloce e sicuro.

- Struttura in acciaio inox.
- Rulli e astine in alluminio anodizzato.
- Piano riscaldante regolabile tramite termostato.
- Profilo teflonato (non provoca fumo).

*Designed for packing meat, cheese, pasta, fruits and vegetables; our wrapping machines offer a fast hygienic service for supermarkets, butcher's, delicatessens and wherever fresh products retail needs a quick and safe daily packaging.*

- Structure in stainless steel.
- Reels and rods made of anodized aluminum.
- Heating surface temperature adjustable by thermostat.
- Teflon coated section. (do not smoke).



Profilo teflonato  
Teflon-coated section

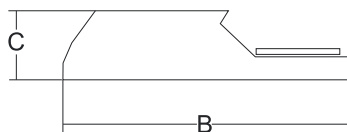
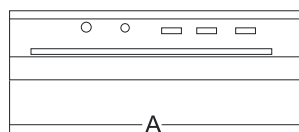

	kw	1ph	mm	mm	mm	mm	mm	kg	mm	kg
45K	120		400	385x125	485	600	140	5	510x610x160	6



# HW 45

## scrotolatore vitafilm hand wrapper

- Pratico scrotolatore di vitafilm per un facile e veloce confezionamento.
- Costruzione struttura in acciaio inox.
- Rulli di supporto vitafilm in alluminio.
- Possibilità di taglio in entrambi i versi.
- Massima larghezza del rotolo vitafilm mm 450.
- Massimo diametro del rotolo vitafilm mm 110.
- Privo di collegamento elettrico rende lo scrotolatore facile da maneggiare e da spostare.
- Facile sostituzione del film.
- *Practical handwrapper for a easy and fast packaging.*
- *Stainless steel frame.*
- *Aluminium support rollers.*
- *Cutting system on both sides.*
- *Maximum width of film is mm 450.*
- *Maximum diameter of film is mm 110.*
- *No electrical connection therefore can be easily positioned in different places.*
- *The film can be easily replaced.*

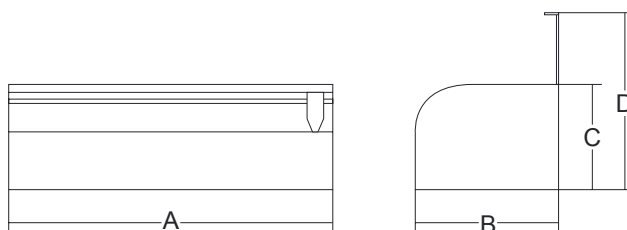

		<b>A</b>	<b>B</b>	<b>C</b>	<b>D</b>	<b>KG</b>		
	mm	mm	mm	mm	mm	kg	mm	kg
<b>HW 45</b>	ø110x450	560	210	173	310	2.8	540x240x210	4



# S 300/2 - S 400/2 - S 400/2T



S 300/2

## sigillatrici sealers

Sigillatrici dal veloce e facile utilizzo sono indispensabili nella gestione degli alimenti. Possono saldare 2 mm di spessore per una lunghezza di 300 o 400 mm tutti i tipi di sacchetti in plastica per alimenti.

Il temporizzatore posto frontalmente permette la sigillatura di sacchetti con spessori diversi, mentre il modello S400/2T dotato di tagliatina permette di eliminare la parte residua del sacchetto. Materiale sigillabile: PE, PP, LDPE, PVC.

*Fast and easy-to-use sealers are indispensable devices for food management.*

*These can seal all types of plastic bags for food, with thicknesses of up to 2mm and across a length of 300 or 400mm.*

*The timer fitted at the front is used to seal bags of different thicknesses, while model S400/2T, fitted with a cutter, eliminates the remaining parts of the bags.*

*Sealable materials: PE, PP, LDPE, PVC.*

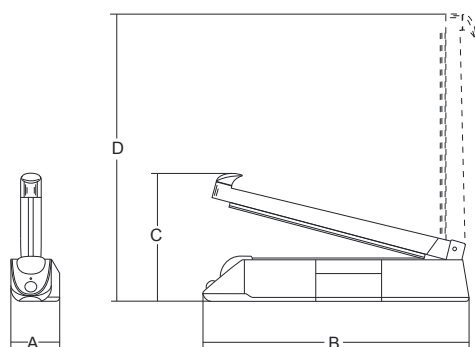

Timer tempo sigillatura  
Timer for sealing time



Tagliatina su modello S 400/2T  
Cutter on model S 400/2T

							<b>A</b>	<b>B</b>	<b>C</b>	<b>D</b>	
	watt	°C	sec.	sec.	mm	mm	mm	mm	mm	mm	kg
<b>S 300/2</b>	510	150 max	min. 0,5/ max 2,5	1,5	200+300	0,5	75	455	260	520	3,5
<b>S 400/2</b>	700	150 max	min. 0,5/ max 2,5	1,5	200+400	0,5	75	555	260	620	4
<b>S 400/2T</b>	700	150 max	min. 0,5/ max 2,5	1,5	200+400	0,5	75	555	260	620	4



S 400/2



S 400/2T



# ORTOLINA

## tagliaverdure manuale manual vegetable cutter

- Tagliaverdure manuale.
- Totalmente costruita in acciaio inox.
- Piedini in gomma antiscivolo.
- Pratica e ripiegabile.
- Sei tipi di lame intercambiabili per taglio a julienne: 2; 3; 4; 5; 6 e 10 mm di larghezza.
- Tre tipi di taglio: Fette; Julienne; Fette ondulate.
- Regolabile in altezza da 1 a 6 mm per fette e julienne.
- Regolabile in altezza da 1 a 4 mm per fette ondulate.
- *Manual vegetable cutter.*
- *Completely stainless steel.*
- *Nonslip rubber feet.*
- *Functional and bendable.*
- *6 different interchangeable blades for julienne cutting: 2, 3, 4, 5, 6 and 10 mm width.*
- *3 different cutting possibilities: Slices; Julienne; Wavy slices.*
- *Adjustable thickness from 1 to 6 mm for slices and julienne.*
- *Adjustable thickness from 1 to 4 mm for wavy slices.*



Leve regolazione spessore di taglio  
Cutting width adjustment levers



Supporto verdura e lame in dotazione  
Vegetable support and blades supplied



Max spessore di taglio 6 mm  
Max cutting width 6 mm



Min. spessore di taglio 1 mm  
Min. cutting width 1 mm



Leva per cambio lame  
Blade change lever



Leva per cambio lame  
Blade change lever

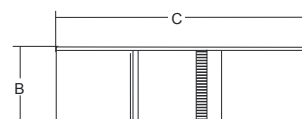
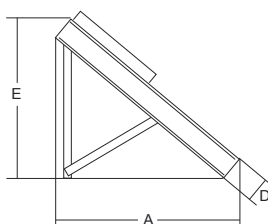

	(A)	(B)	(C)	(D)	(E)			
	mm	mm	mm	mm	mm	kg	mm	kg
Ortolina	370	140	405	40	240	1.7	230x150x540	2

# SMOKERBAG



Prodotto in Finlandia, SmokerBag è la soluzione innovativa per affumicare in modo semplice, salutare ed ecologico qualsiasi pietanza – carne, pesce, verdure e persino frutta e cioccolato – ogni giorno e in ogni stagione.

SmokerBag è un capiente sacchetto di alluminio pesante con un doppio fondo che contiene piccoli trucioli di legno d'ontano, sciroppo di betulla e zuccheri naturali. Quando SmokerBag viene portato a temperatura in forno o sulla griglia, queste sostanze naturali producono una leggera affumicatura del cibo racchiuso all'interno, e una cottura al cartoccio che lo mantiene sempre tenero e succoso.

Nella mani dello chef, SmokerBag diventa un raffinato strumento estremamente versatile e ricco di potenzialità. Ideale per riscoprire un aroma tipicamente nordico con il gusto e la fantasia dell'arte culinaria italiana.

Dimensioni 28x42 cm

## INDICAZIONI D'USO:

1. Inserire le pietanze nel sacchetto SmokerBag e richiuderlo, facendo attenzione che la dicitura this side down sia sempre rivolta verso il basso.
2. Metterlo nel forno preriscaldato o sulla griglia.
3. Affumicare per un tempo variabile, secondo la creatività dello chef.
4. Aprire SmokerBag con cautela, facendo attenzione alla fuoriuscita di vapore.
5. Utilizzare il sacchetto una sola volta.

## ATTENZIONE:

- SmokerBag non deve mai entrare in contatto con la fiamma viva.
- SmokerBag non deve mai essere capovolto.
- SmokerBag non è adatto al forno a microonde.

*SmokerBag, a new product produced in Finland, is an innovating solution for an easy, healthy and ecological smoking of any food – meat, fish, vegetables and even fruit – in any time of the year.*

*SmokerBag is a large aluminium bag with a double wall containing minute chips of alder wood, birch syrup and natural sugar. When SmokerBag reaches the working temperature in the oven or on the grill, these natural ingredients produce a light smoking of food in the bag, and the baking in foil keeps it soft and juicy.*

*SmokerBag is a fine tool in the hands of the chef, gaining benefit from its great versatility and potentials and blending a peculiar Nordic flavour with different culinary arts.*

Dimensioni 28x42 cm

## INSTRUCTIONS:

1. Put food in the SmokerBag, then close the bag. Pay attention: caption "This side down" must be on the bottom side.
2. Put the bag in the preheated oven or on the grill.
3. Smoking time depends on the chef's creativity.
4. Open the SmokerBag carefully, paying attention to issuing vapour.
5. SmokerBag can only be used once.

## ATTENTION:

- SmokerBag can never be on contact with blazes.
- Never turn SmokerBag upside-down.
- Never put SmokerBag in the microwaves oven.

# TEGI



termometro digitale  
digital thermometer



## CARATTERISTICHE TECNICHE:

- Risoluzione: 0.1°C / 0.1 °F
- Batterie: watt 1 x LR44 1.5V
- Temperatura rilevata dall'ago: max + 300°C - min. - 50°C
- Dimensioni ingombro: mm 25x150

## TECHNICAL FEATURES:

- Resolution 0.1°C / 0.1 °F
- Battery watt 1 x LR44 1.5V
- Temperature from stem max + 300°C - min. - 50°C
- Overall dimensions mm 25x150



# PLUTONE 7-10-20-30

## planetarie planetary mixers

### PLUTONE 7 - 7 PLUS

- Impastatrice planetaria interamente in metallo;
- Testa alzabile per smontaggio vasca, sostituzione utensile e pulizia generale.
- Vasca smontabile inox da litri 7.
- Motore in CC con variatore di velocità.
- Trasmissione ad ingranaggi lubrificati a grasso.
- Microinterruttori su alzata testa.
- Dispositivo NVR.
- La macchina è indicata per impasti morbidi, per impasti di media consistenza (es. pane) si consiglia max 1 kg di farina.
- NON è adatta per impasti molto duri (es. taralli).
- *Metal cast planetary mixer.*
- *Liftable head for bowl and tools removal and easy claeing.*
- *Removable, S/S, 7L bowl.*
- *D.C. motor with speed control.*
- *Gear drive and grease lubrication.*
- *Safety microswitch on the head.*
- *NVR device.*
- *Suitable for soft dough, for medium dough (for ex. Bread) it is advisable max 1 kg of flour.*
- *NOT suitable for tough mix. (for ex. taralli).*

### PLUTONE 7

- Manopola fissaggio rapido testa.
- 3 utensili in metallo.
- *Head fast fixing knob.*
- *3 metal tools;*

### PLUTONE 7 PLUS

- Motore potenziato a 350 Watt.
- Sistema di trasmissione ad ingranaggi ingrandito e potenziato.
- Leva fissaggio rapido testa.
- 3 utensili in acciaio inox.
- *Upgraded power motor 350 W.*
- *Upgraded gear system size.*
- *Head fast fixing handle.*
- *3 s/steel tools.*

### PLUTONE 10 - 20 - 30

- Protezione della vasca in filo metallico.
- Vasca in acciaio inox 304 facilmente smontabile.
- Dispositivo di sicurezza all'apertura della protezione e abbassando la vasca.
- 3 accessori di lavorazione facilmente sostituibili: spatola e gancio in fusione di alluminio / frusta in fusione di alluminio e acciaio.
- Cambio meccanico a 3 velocità.
- Sistema di riduzione con ingranaggi in acciaio.
- Motore ventilato.
- *Bowl protection made from metal wire.*
- *Easy to remove bowl made from stainless steel 304.*
- *Safety microswitches for the lid and the bowl.*
- *3 easy to remove metal tools: aluminium spatula and hook, / steel and aluminium whisk.*
- *3 speed gear.*
- *Steel gear box.*
- *Ventilated motor.*

### PLUTONE 10 - 20

- Solida struttura in fusione verniciata.
- Sturdy frame from large thickness

### PLUTONE 30

- Solida struttura in carpenteria smaltata
- Comandi con timer
- Presa di forza.
- *Enamelled metal sturdy frame*
- *Controls with timer*
- *PTO*



PLUTONE 10



PLUTONE 20



PLUTONE 7

PLUTONE 30



Tramoggia per aggiunta ingredienti  
Feed tray for add ingredients





Accessori inox Plutone 7 Plus  
Plutone 7 Plus standard accessory



PLUTONE 7



PLUTONE 10 - 20



PLUTONE 30

Plutone 7 - 7 Plus

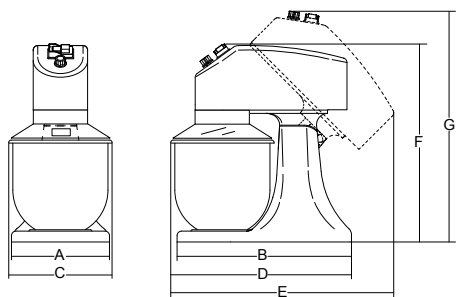

Plutone 10 - 20 - 30

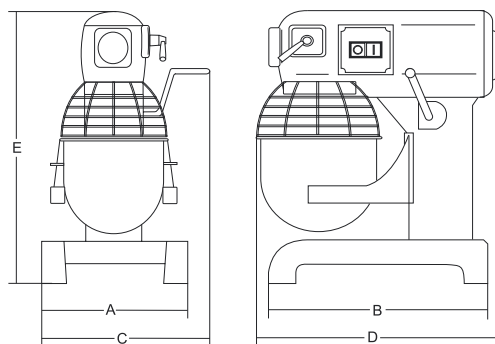

	watt	1ph	giri/min.	lt	mm	mm	mm	mm	mm	mm	kg	mm	kg	
<b>Plutone 7</b>	280	1ph	75 ÷ 660	7	220	285	240	410	450	437	510	18	470x320x500	21
<b>Plutone 7 Plus</b>	350	1ph	75 ÷ 660	7	220	285	240	410	450	437	510	18	470x320x500	21
<b>Plutone 10</b>	450	1ph	1 = 108 2 = 195 3 = 355	10	360	345	440	500	630	-	-	40	470x550x750	55
<b>Plutone 20</b>	1.100	1ph	1 = 97 2 = 220 3 = 316	20	420	440	515	560	770	-	-	99	570x630x920	125
<b>Plutone 30</b>	1.500	1ph	1 = 93 2 = 167 3 = 285	30	580	660	630	650	1160	-	-	187	750x730x1300	207



# ELDORADO

friggitrici  
fryers



ELDORADO 8X2R

- Costruita in acciaio inox.
- Cestello rinforzato.
- Termostato e sonda cut-off di sicurezza e pulsante di ripristino.
- Resistenze corazzate.
- Corpo riscaldante rimovibile e micro di sicurezza.
- Protezione antiurto su resistenze facilmente smontabile.
- Posizione di sgocciolo per cestello.
- Coperchio in dotazione.
- Rubinetto opzionale.

- *Made from stainless steel.*
- *Reinforced basket.*
- *Thermostat and safety cut-off probe and reset button.*
- *Shock-proof coated heating elements.*
- *Removable heating body and safety switch.*
- *Shockproof protection on resistances easily disassembled.*
- *Position of basket drip.*
- *Lid supplied.*
- *Tap optional.*



ELDORADO 5



ELDORADO 5X2



ELDORADO 8R



ELDORADO 8X2



Protezione antiurto resistenze  
Shockproof protection for resistances



Posizione di sgocciolo  
Position of drip



Pratico cestello da maneggiare  
Easy to handle basket



(A) Bulbo termostato  
(B) Pulsante di ripristino cut-off  
(A) Thermostat bulb  
(B) Cut-off reset button

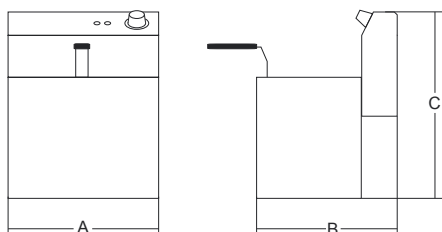

Facile da smontare e pulire  
Easy to disassemble and clean

					<b>A</b>	<b>B</b>	<b>C</b>			
	watt	ph	lt	mm	mm	mm	mm	kg	mm	kg
<b>Eldorado 5</b>	2.700	1ph	min. 1,8 - max 3,2	220x120 h.100	180	420	360	6	260x590x450	7
<b>Eldorado 5x2</b>	2.700+2.700	1ph	min. 1,8 - max 3,2	220x120 h.100 (x2)	360	420	360	12	720x540x480	13
<b>Eldorado 5+8</b>	2.700+3.300	1ph	5 - min. 1,8 - max 3,2 8 - min. 3 - max 5	220x120 h.100 230x205 h.100	450	420	360	13	720x540x480	14
<b>Eldorado 8</b>	3.300	1ph	min. 3 - max 5	230x205 h.100	270	420	360	7	570x320x420	8
<b>Eldorado 8x2</b>	3.300+3.300	1ph/3ph	min. 3 - max 5	230x205 h.100 (x2)	530	420	360	14	720x540x480	15
<b>Eldorado 8R</b>	3.300	1ph	min. 3 - max 5	230x205 h.100	270	420	360	7,5	570x320x420	8,5
<b>Eldorado 8x2R</b>	3.300+3.300	1ph/3ph	min. 3 - max 5	230x205 h.100 (x2)	530	420	360	15	570x540x480	16
<b>Eldorado 10R</b>	6.000	3ph	min. 3,8 - max 6	250x240 h.100	270	460	360	9	720x540x480	10
<b>Eldorado 10X2R</b>	6.000+6.000	3ph	min. 3,8 - max 6	250x240 h.100 (x2)	520	460	360	18	720x540x480	20



ELDORADO 10X2R



ELDORADO 10R



ELDORADO 5+8



# KLONDIKE

## friggitrice ad induzione induction deep fryer



- Struttura totalmente in acciaio inox.
- Pratico rubinetto per scarico dell'olio.
- Veloce, semplice ed estremamente facile da pulire.
- Comandi touch a prova di liquidi.
- Temperatura settabile fino a 190°, (range di temperatura 60°-190°).
- Funzione timer, fino ad un massimo di 120 minuti.
- Pratico visore digitale della temperatura.
- Pratico richiamo controllo olio all'accensione.
- Protezione termica di sovrariscaldamento.
- Arresto automatico per inutilizzo.

- *Stainless steel structure.*
- *Handy tap for oil removal.*
- *Quickly heating and extremely easy to clean.*
- *Splash-proof touch controls.*
- *Temperature regulation up to 190° (range is from 60° to 190°).*
- *Easy setting timer to 120 minutes.*
- *Extremely visible digital display.*
- *Buzzer alarm to remind oil level check.*
- *Oil overheat protection.*
- *Automatically shut down if unused.*



Pratico cestello da maneggiare  
Easy to handle basket



							A	B	C	D	E	F			
	watt	ph	min.	°C	lt	mm	mm	mm	mm	mm	mm	mm	kg	mm	kg
<b>Klondike 8R</b>	3.500	1ph	120	60 ÷ 190	8	180x218 h.135	247	345	290	440	590	407	12.2	565x350x478	13.9



# PASTÌ

## cuocipasta pasta cookers



PASTÌ 10



PASTÌ 8



- Struttura e vasca in acciaio inox.
- Cestelli microforati in acciaio inox con pratica impugnatura.
- Speciali resistenze corazzate antiruggine.
- Termostato di controllo.
- Protezione termica di sicurezza.
- Rubinetto carico/scarico acqua di serie.

- Structure and tank in stainless steel.
- Micro-drilled basket in stainless steel with handy grip.
- Special armored rust-proof heaters.
- Control thermal switch.
- Safety heat guard.
- Standard feature: inlet/outlet water faucet.



Cestello per cottura a vapore opzionale  
Optional steam cooking basket



Cestello maxi:  
di serie per PASTÌ 10 / opzionale per PASTÌ 8  
Maxi basket:  
standard for PASTÌ 10 / optional for PASTÌ 8

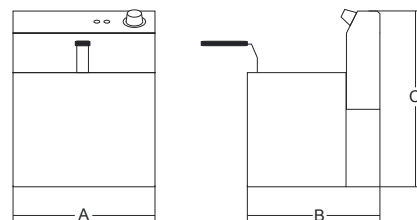

	watt	1ph	lt	mm	mm	mm	mm	kg	mm	kg
<b>PASTÌ 8</b>	3.000	1ph	6	100x120 h.130 (x4)	270	420	360	8.5	670x450x480	10
<b>PASTÌ 10</b>	6.000	3ph	8	95x220 h.130 (x3)	270	525	360	9.5	670x450x480	11





# MINICOOKER - MYCOOK

frullatore termico semiprofessionale  
*semi-professional thermal blender*

- Frullatore termico semiprofessionale.
- Pratico ed irrinunciabile aiuto in cucina.
- Potente motore separato dalla zona cottura.
- Riscaldamento ad induzione che dimezza i tempi di messa in temperatura.
- Minicooker dotato di bilancia da 5 Kg con tara.
- Variatore velocità con 10 livelli.
- Potenziometro per cotture fino a 120°.
- Pratica vasca in acciaio inox da 2 Lt .
- Mozzo coltelli a smontaggio rapido per una facile pulizia.
- Coperchio con chiusura di sicurezza.
- Dotato di spatola, farfalla mescolatrice e cestello forato.
- Tappo aggiunta ingredienti con dosatore.
- Programma soffritti.
- Set per cottura a vapore opzionale.

- *Hand-held mixers.*
- *Practical, must-have kitchen aid.*
- *Powerful motor separated from the cooking zone.*
- *Induction heating which halves the time required to reach desired temperature.*
- *Minicooker supplied with 5 kg scales with tare.*
- *Speed changer.*
- *Potentiometer for cooking to 120°.*
- *Practical 2 L stainless steel bowl.*
- *Knife hub quick to dismantle for easy cleaning.*
- *Lid with safety closure.*
- *Spatula, butterfly mixer and perforated basket supplied.*
- *Add ingredients cap with measuring device.*
- *Sautéed vegetable program.*
- *Steam cooking set optional.*

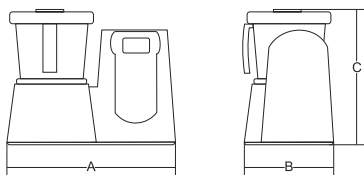

MINICOOKER



Applicazione opzionale Steamer  
*Steamer cooking set optional*

							A	B	C			
	watt	1ph	watt	n.	°C	lt	mm	mm	mm	kg	mm	kg
<b>Minicooker</b>	600	1ph	1.000	10	120	2	360	300	290	10	400x370x540	11
<b>Mycook</b>	800	1ph	1.000	10	120	2	360	300	290	9	400x370x540	10



MYCOOK





# FORCELLA



## impastatrici pizza dough mixers









Impastatrici a forcella ideali per la lavorazione di impasti per pane, pizza, piadine romagnole o di pasta fresca per tagliatelle e ravioli.

- Vasca in acciaio inox.
- Ampio coperchio in materiale antiurto trasparente.
- Forcella in acciaio, attentamente studiata per ottimizzare l'impasto.
- Trasmissione del moto tramite due motoriduttori ad ingranaggi.
- Disponibile anche in due velocità.

*Fork dough mixers that are perfect to mix dough for bread, pizza, piadina pancakes, or fresh pasta for tagliatelle noodles and stuffed ravioli.*

- Tank in stainless steel.
- Wide lid in transparent, collision-proof material
- Steel fork carefully studied to improve the dough product.
- Drive transmission provided by two reduction gears.
- Is also available in two speed versions.



								
	kw		lt	kg	mm	kg	mm	kg
<b>Forcella 20</b>	0.55	1ph/3ph	27	20	560x890 h.680	100	670x1020x880	116
<b>Forcella 35</b>	0.75	1ph/3ph	39	35	600x930 h.680	104	670x1020x880	120
<b>Forcella 50</b>	1	3ph	67	50	680x1100 h.770	151	880x1120x960	175



# EKTOR

## estrattore slow Juicer

Estrattore a bassa velocità per l'estrazione di succhi a freddo da frutta e verdura.

- Struttura esterna in acciaio inox.
- Speciale tramoggia di introduzione che agevola il carico dei pezzi più grossi.
- Coclea ad alta efficienza.
- Tappo salvagoccia.
- Pratico e veloce smontaggio delle parti interessate alla lavorazione.
- Pestello per agevolare l'avanzamento dell'alimento inserito.
- Spazzola per la pulizia.
- Vaschetta per gli scarti e una per il succo, di serie.
- Dotato di 3 cestelli con diversa foratura, anche per sorbetti.
- Potente motore asincrono ventilato con riduzione ad ingranaggi.

*Low-speed juicer extractor for fruits and vegetables*

- *Stainless steel construction.*
- *Special introduction hopper for easy loading of larger pieces.*
- *High efficiency screw propeller.*
- *Drip cap.*
- *Quick and easy disassembly of the parts used for processing.*
- *Pestle for easy introduction of the products.*
- *Cleaning brush.*
- *Equipped with 2 trays: one for juice and one for waste.*
- *Equipped with 3 different drilling strainers.*
- *High efficiency asynchronous ventilated motor.*



Tappo salvagoccia  
Drip cap



Vaschetta per gli scarti  
Tray for waste



Speciale tramoggia di introduzione che agevola il carico dei pezzi più grossi.  
*Special introduction hopper for easy loading of larger pieces.*





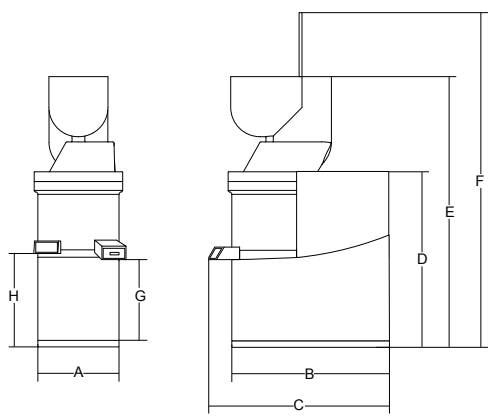

	watt/HP	1ph	r.p.m.	mm	mm	mm	mm	mm	mm	mm	mm	mm	kg	mm	kg
<b>Ektor 37</b>	250/0.34		37	140x80	145	220	240	342	450	530	160	166	6.7	370x290x340	8





# SALENTO - SOAVE - COLLI ORIENTALI - MONFERRATO

## cantinette wine cooler

- Porta con vetro temperato doppio, compresa di serratura con chiave, reversibile.
- Ripiani estraibili in legno.
- Comandi digital touch.
- Regolazione termostato in °C o °F.
- Display e luce interna a led.
- Autosbrinamento.
- Filtro attivo al carbone.
- Ventilazione interna.
- I modelli da 150 lt sono predisposti da semincasso.

- *Door with double tempered glass and key lock system, reversible.*
- *Removable wood shelves.*
- *Digital touch controls.*
- *Thermostat adjustment in °C or °F.*
- *LED display and interior light.*
- *Auto-defrost.*
- *Active carbon filter.*
- *Interior fan.*
- *150 lt models can be semi built-in.*



SALENTO



SOAVE



COLLI ORIENTALI



MONFERRATO



SOAVE / SALENTO



MONFERRATO



COLLI ORIENTALI



MONFERRATO

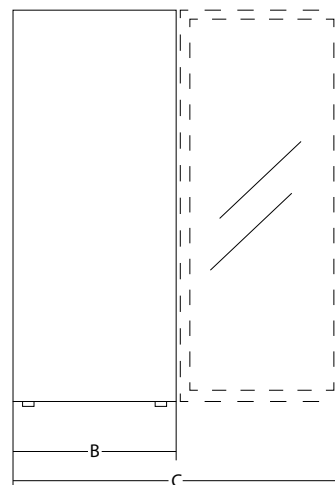
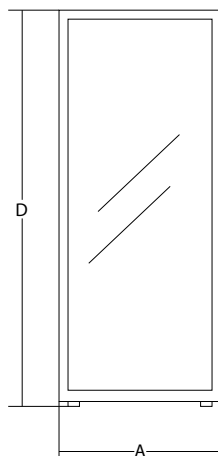
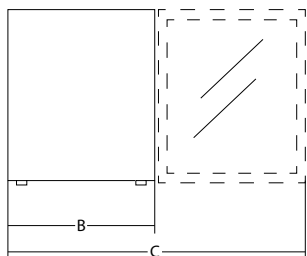
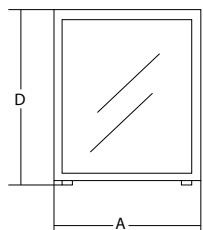

SOAVE / SALENTO

COLLI ORIENTALI / MONFERRATO

							A	B	C	D			
	watt	r.p.h.	r.p.m.	mm	mm	lit	mm	mm	mm	mm	kg	mm	kg
<b>Salento</b>	120	1ph	5-22	1	51	150	595	575	1.145	850	43	655x675x865	49
<b>Soave</b>	120	1ph	5-12 / 12-22	2	51	150	595	575	1.145	850	43	655x675x865	49
<b>Colli Orientali</b>	150	1ph	5-12/12-22	2	96	270	595	590	1130	1.640	75	655x620x1700	80
<b>Monferrato</b>	160	1ph	5-12 / 12-22	2	182	450	595	760	1380	1800	90	650x765x1830	95



SALENTO

SOAVE

COLLI ORIENTALI

MONFERRATO



# CARRELLI E TAVOLI INOX

trolley and s/steel working table



### TROL 1 HD

- mm 900x600 h.900
- capacity kg 300
- cod.75010000



### TROL DW

- mm 520x620 h.920
- cod.75012000



### TROL D

- mm 980x515 h.830
- cod.75057000



### TROL 2 D

- mm 855x535 h.940
- capacity kg 40 per piano/layer
- cod.75000210



### TROL 2

- mm 855x535 h.930
- capacity kg 40 per piano/layer
- cod.75000200



### TROL 3

- mm 855x535 h.930
- capacity kg 40 per piano/layer
- cod.75000300



### TROL CNT

- mm 750x470 h.740
- cod.75011000



### VAN 7 BP

- mm 470x620 h.915
- n.7 teglie/tray - cm 60x40
- capacity kg 10 per piano/layer
- cod.75056407



### VAN 7 GN

- mm 385x550 h.870
- n.7 teglie/trays - 1/1 GN
- capacity kg 10 per piano/layer
- cod.75050700



**VAN 15 BP**

- n.15 teglie/trays cm 60x40
- capacity kg 15 per piano/layer
- cod.75056415



**VAN 15 GN**

- mm 385x550 h.1735
- n.15 teglie/trays - 1/1 GN
- capacity kg 15 per piano/layer
- cod.75001500



**VAN 30 GN**

- mm 740x550 h.1735
- n.15x2 teglie/trays - 1/1 GN
- capacity kg 15 per piano/layer
- cod.75003000



**TAB 167**

- mm 1600x700 h.860
- capacity kg 300
- cod.75061672



**TAB 167A**

- mm 1600x700 h.950
- capacity kg 300
- cod.75061670



**SHEL 410**

- mm 1000x500 h.1550
- capacity kg 400
- cod.75010410

**SHEL 412**

- mm 1200x500 h.1550
- capacity kg 400
- cod.75010400

**SHEL 414**

- mm 1400x500 h.1550
- capacity kg 400
- cod.75010420



**SHEL P12**

- mm 1200x300x220
- cod.75010500

**SHEL P15**

- mm 1500x300x220
- cod.75010510



# BBQ X3 - X4

## barbecue



- BBQ a gas da esterni con coperchio e termometro.
- Griglia di cottura suddivisa in 3 o 4 zone con comandi separati.
- Coperchio, plancia comandi e portine in acciaio inox.
- Struttura e piani di appoggio in acciaio laccato.
- Griglie inox facilmente smontabili per la pulizia.
- Utile ripiano rialzato per il mantenimento in temperatura.
- Pratico raccogli liquidi di colatura sotto ai bruciatori con vaschetta asportabile.
- Fornello laterale integrato con coperchio.
- 4 ruote con freno.
- Viene spedito smontato.
- *Outdoor BBQ with lid and thermometer.*
- *Cooking grille divided into 3 or 4 areas with separate controls.*
- *Lid, control panel and doors all in stainless steel.*
- *Frame and work surfaces in lacquered steel.*
- *Stainless steel grilles, easily removable for cleaning.*
- *Useful raised shelf to keep food warm.*
- *Practical, removable tray under the burners for collecting cooking juices.*
- *Integral side gas ring with lid*
- *4 wheels and a brake.*
- *The product is sent ready to assemble.*



BBQ X3



BBQ X4



Girarrosto opzionale  
Optional rotisserie spit



Termometro sul coperchio  
Thermometer on lid



Fornello laterale integrato con coperchio  
Integral side gas ring with lid



Griglie in ghisa opzionali  
Optional cast iron grilles



Vaschetta raccogli liquidi asportabile  
Tray for collecting cooking juices

	(A)	(B)	(C)	(D)	(E)	(F)	(G)	(H)
	mm	mm	mm	mm	mm	mm	mm	mm
BBQ X3	600	515	1224	90	867	1140	1470	310
BBQ X4	707	515	1330	90	867	1140	1470	310



BBQ X3



BBQ X4

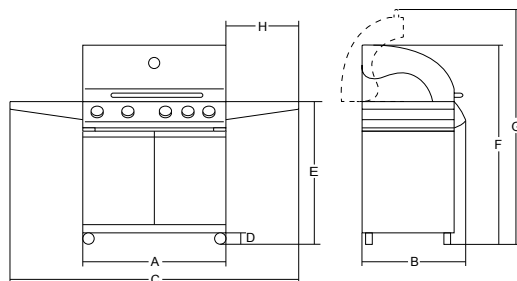

**SANYO**  
PROFESSIONAL

## SAR-C 447 E



### vetrinetta frigo refrigerated glass case

- Vetrinetta frigo dal design moderno studiata per accogliere in uno spazio ridotto grandi quantitativi di prodotti.
- Caratterizzata da spondine laterali trasparenti, porta posteriore per l'aggiunta e sistemazione del prodotto, regolazione della temperatura dal retro e termometro interno visibile.
- Pratica e facile da gestire, è indicato per supermercati, alimentari, ristoranti, palestre, ecc.
- *The refrigerated glass case has a modern design and has been studied to fit a large quantity of products into a small space.*
- *It is characterized by transparent side panels, a back door for adding or moving products around, temperature adjustment from the back and a visible internal thermometer.*
- *Practical and easy to manage, it is ideal for supermarkets, food stores, restaurants, gyms, etc.*

#### CAPACITÀ PRODOTTO

- pz. 97 bottiglie (h. 122 x ø 45 mm)
- pz. 74 lattine (250 ml - h. 133 x ø 53 mm)
- pz. 48 lattine (350 ml - h. 122 x ø 66 mm)
- pz. 30 bottiglie (500 ml - h. 209 x ø 68,5 mm)

#### PRODUCT CAPACITY:

- *pz. 97 bottles (h. 122 x ø 45 mm)*
- *pz. 74 cans (250 ml - h. 133 x ø 53 mm)*
- *pz. 48 cans (350 ml - h. 122 x ø 66 mm)*
- *pz. 30 bottles (500 ml - h. 209 x ø 68,5 mm)*



	watt	1ph	GAS	°C	lt	mm	mm	kg	mm	kg
SAR-C447 E	260	1ph	HFC 134a	5 - 20	40	430x289x348	490x490x715	31	550x550x800	34



# WF 431 ABP

## lavatrici washing machines



- PowerFoam
- Ciclo di lavaggio Eco Cold:
- Utilizza acqua fredda e schiuma con la stessa efficacia di un normale ciclo con acqua calda, ma con il 65% di energia in meno.
- VRT™ - Vibration Reduction Technology
- Estrema silenziosità di funzionamento
- Cestello in acciaio inox con Diamond Drum™ Design
- 13 cicli di lavaggio con 10 opzioni
- Velocità massima di rotazione: 1.300 RPM
- Motore a presa diretta
- Riscaldatore interno dell'acqua (ciclo di lavaggio e sterilizzazione)
- Indicatore temperatura acqua
- Qualificato Energy Star®
- Illuminazione cestello
- Segnale di fine ciclo
- Accensione differita – fino a 24h
- Erogatore automatico: pre-lavaggio, lavaggio principale, candeggio, lavaggio con ammorbidente
- Base e kit per sovrapposizione disponibili come optional
- LED display
- 5 livelli di temperatura:
- Molto calda/Fredda, Calda/Fredda, Calda/Calda, Calda/Fredda, Fredda/Fredda
- 5 velocità centrifuga:
- Molto alta, Alta, Media, Bassa, No Centrifuga
- Durata programmi standard:
- Cotone 60°C a pieno carico: 216 min
- Cotone 60°C a carico parziale: 196 min
- Cotone 40°C a carico parziale: 166 min.
- Emissione acustica lavaggio dB 60
- Emissione acustica centrifuga dB 70
- Classe di efficienza energetica: A++
- Classe di efficienza centrifuga: B

- PowerFoam
- Eco Cold Wash Cycle:
- Use cold water and foam to clean clothes just as effectively as a conventional warm water cycle and at 65% less energy.
- VRT™ - Vibration Reduction Technology
- Quiet Operation.
- Stainless steel Diamond Drum™ Design
- 13 Wash Cycles and 10 Options
- 1.300 RPM Maximum Spin Speed
- Direct Drive Motor
- Internal Water Heater (Sanitize Wash Cycle)
- Water Temperature Sensor
- Energy Star® Qualified
- Washer Drum Light
- End Of Cycle Signal
- Delay Start - up to 24 hours
- Automatic Dispensers: Pre-Wash, Main Wash, Bleach, Fabric Softener
- Optional Pedestals or Stacking Kit Available
- Graphic LED display
- 5 Temperature Settings:
- Extra Hot/Cold, Hot/Cold/, Warm/Warm, Warm/Cold, Cold/Cold
- 5 Spin Speeds:
- Extra High, High, Medium, Low, No spin
- Duration of the standard programs:
- Cotton 60 °C at full load: 216 min
- Cotton 60 °C for partial load: 196 min
- Cotton 40 °C with partial load: 166 min.
- Washing acoustic emission 60 dB
- Spin acoustic emission 70 dB
- Energy Efficiency: A++
- Spin efficiency class: B



Cestello in acciaio inox Diamond Drum™  
Stainless steel Diamond Drum™

	watt	kPa	r.p.m.	kg	mm	mm	kg	mm	kg	
<b>WF 431 ABP</b>	2.000/2.400	1ph	137-800	1.200	14	ø570x450	690x820 h.980	99	760x840x1050	102





# DV 431 AEP



- Steam Drying Technology
- 13 Pre-set Dry Cycles and 8 Options
- Stainless steel drum
- Dryer Drum Light
- Washer Drum Light
- My Cycle
- Filter check indicator
- Remaining Time Display
- Optional Pedestals or Stacking Kit Available
- Woolmark Certified for more gentle handling and anti-shrinking
- Steam Refresh: infuses clothes with steam to reduce wrinkles, remove odours, and refresh clothing
- Sensor Dry: detects the moisture level in the load and adjusts the drying time to save time and money
- Wrinkle Prevent Option: intermittently tumbles clothes at the end of the drying cycle to help prevent wrinkles from setting in.
- Mixed Load Bell: notifies you that certain garments can be taken out early while letting others continue to dry. Heavier and tougher clothes that require extra drying time then stay in the machine to be dried further, and quicker.
- 5 Temperature Settings
- 5 Dry Levels
- 5 Signal Sound Levels

## asciugatrici dryers

- Asciugatura a vapore (Steam Drying Technology)
- 13 cicli di asciugatura con 8 opzioni
- Cestello in acciaio inox
- Porta con finestra trasparente
- Illuminazione cestello
- Funzione MyCycle
- Indicatore controllo filtro
- Indicazione tempo rimanente
- Base e kit per sovrapposizione disponibili come optional
- Certificata Woolmark per un trattamento più delicato ed anti infeltrimento della lana
- Steam Refresh: l'emissione di vapore riduce le pieghe, rimuove gli odori e ridà tono agli indumenti.
- Sensor Dry: un sensore rileva il grado di umidità nel carico e regola il tempo di asciugatura per risparmiare tempo e denaro.
- Funzione anti pieghe: alla fine del ciclo rigira gli indumenti a intermittenza per prevenire pieghe.
- Mixed Load Bell: avvisa che alcuni indumenti possono essere rimossi. I capi che richiedono maggiore tempo per asciugare rimangono quindi nella macchina per completare, più in fretta, l'asciugatura.
- 5 livelli di temperatura
- 5 livelli di asciugatura
- 5 livelli di segnale acustico



Cestello in acciaio inox  
Stainless steel drum

	watt	watt	watt	r.p.m.	kg	mm	mm	kg	mm	kg	
DV 431 AEP	200	4.900	4.700	1ph	1.200	10	ø670x640	690x790 h.990	57.2	760x840x1080	61

## Ambiente di utilizzo / Use destination

-  Domestico / Household / Haushalt / Ménage / Домашнее / 家用
-  Bar / Bar and pubs / Café / Бар / 酒吧
-  Snack / Imbiss / Закусочная (Снеки) / 快餐店
-  Fast Food / Фаст-фуд / 快餐
-  Piccola pizzeria / Small pizza-restaurant / Маленькая пиццерия / 小型比萨饼店
-  Piccolo ristorante / Small restaurant / Маленький ресторан / 小型饭店
-  Ristorante / Restaurant / Ресторан / 饭店
-  Grosso ristorante / Big restaurant / Большой ресторан –пиццерия / 大型饭店-比萨饼店
-  Catering / Catering business / Катеринг / 食堂
-  Comunità / Communities / Общепит / 社区
-  Salumeria / Grocery / Колбасный отдел / 香肠店
-  Macelleria / Butchery / Мясной магазин / 肉食店
-  Supermercato / Supermarket / Супермаркет / 超市
-  Industria / Industry / Индустрия / 食品加工工业
-  Mense / Canteens / Общепит / 社区
-  Negozi-Market / Small deli stores / Магазины мелких гастрономов / 小熟食店
-  Laboratori / Processing departments / Отделы обработки / 加工部门
-  Piccola industria / Small industry / Маленький индустрия / 小行业







## Prodotto / Product

-  Pane / Bread / Brot / Pain / Хлеб / 面包
-  Formaggio / Cheese / Käse / Fromage / Сыр / 奶酪
-  Verdura / Vegetable / Gemüse / Légumes / Овощи / 蔬菜
-  Salami / Sausages / Salami / Saucissons / Колбаса / 香肠
-  Prosciutto cotto / Cooked ham / Gekochter Schinken / Jambon cuit / Вареная ветчина / 熟火腿
-  Prosciutto crudo disossato / Boneless parma ham / Rohschinken ohne Knochen / Jambon cru désossé / Сырая ветчина без костей / 生火腿
-  Prosciutto crudo con osso / Parma ham with bone / Rohschinken mit Knochen / Jambon cru avec os / Сырая ветчина на кости / 带骨生火腿
-  Carne fresca / Fresh meat / Rohes Fleisch / Viande fraîche / Свежее мясо / 生肉
-  Carne cotta / Cooked meat / Gegartes Fleisch / Viande cuite / Вареное мясо / 熟肉
-  Carne congelata (-7°) / Frozen meat (-7°) / Gegartes Fleisch (-7°) / Viande cuite (-7°) / Замороженное мясо (-7°) / 冻肉 (-7°)
-  Pesce / Fish / Fisch / Poisson / Рыба / 鱼类







## Tipo lama / Type of blade

-  Pane / Bread / Brot / Pain / Хлеб / 面包
-  Formaggio / Cheese / Käse / Fromage / Сыр / 奶酪
-  Verdura / Vegetable / Gemüse / Légumes / Овощи / 蔬菜
-  Salami / Sausages / Salami / Saucissons / Колбаса / 香肠
-  Prosciutto cotto / Cooked ham / Gekochter Schinken / Jambon cuit / Вареная ветчина / 熟火腿
-  Prosciutto crudo disossato / Boneless parma ham / Rohschinken ohne Knochen / Jambon cru désossé / Сырая ветчина без костей / 生火腿
-  Prosciutto crudo con osso / Parma ham with bone / Rohschinken mit Knochen / Jambon cru avec os / Сырая ветчина на кости / 带骨生火腿
-  Carne fresca / Fresh meat / Rohes Fleisch / Viande fraîche / Свежее мясо / 生肉
-  Carne cotta / Cooked meat / Gegartes Fleisch / Viande cuite / Вареное мясо / 熟肉
-  Carne congelata (2°) / Frozen meat (2°) / Gegartes Fleisch (2°) / Viande cuite (2°) / Замороженное мясо (2°) / 冻肉 (2°)
-  Pesce / Fish / Fisch / Poisson / Рыба / 鱼类





## Uso / Use

-  Impasti molto duri (patate e farina) / Very hard mixtures (potatoes and wheat)
-  Impasti duri (carne fresca+addensanti) / Hard mixtures (fresh meat+solids)
-  Impasti medi (carne fresca) / Medium mixtures (fresh meat)
-  Impasti liquidi (carne fresca+liquidi) / Soft mixtures (fresh meat+liquids)
-  Prodotti secchi (spezie e polveri) / Dry mixtures (powders and spices)
-  Insalate / Salads

## Tablelle dati tecnici / Technical data

-  Potenza / Power / Spannung / Puissance / Potencia / Potência / Мощность / 功率
-  Alimentazione / Power source / Betriebsspannung / Alimentation / Alimentación / Alimentação / Электропитание / 电源
-  Motore / Motor / Motor / Moteur / Motor / Motor / Двигатель / 电机
-  Peso netto / Net weight / Nettogewicht / Poids net / Peso neto / Pêso líquido / Вес нетто / 净重
-  Dimensioni imballo / Shipping / Verpack. abmessungen / Dim. emballage / Dimensiones embalaje / Dimensões embalagem / Размеры упаковки / 包装尺寸
-  Peso lordo / Gross weight / Bruttogewicht / Poids brut / Peso bruto / Pêso bruto / Вес брутто / 毛重

## Affettatrici / Slicing machines

-  Ø Lama / Ø Blade / Ø Messer / Ø Lame / ø Cuchilla / ø Lâmina / ø лезвия / 刀片直径
-  Spessore taglio / Cut thickness / Schnittbreite / Epaisseur de coupe / Espesor corte / Espessura corte / Толщина нарезки / 切削厚度
-  Corsa carrello / Run of carriage / Wagenschub / Course du chariot / Desplazamiento del carro / Escorrimiento carrinho / Ход каретки / 料斗行程
-  Piatto / Hopper / Wagen grösse / Plateau / Plato / Prato / Лоток / 料斗

 Produzione/h. estrusore / Extruder output/h. / Extruderleistung/h. / Débit/h. extrudeur / Producción/h. extrusora / Produção/h. extrusora / Экструдер Часовая производительность / 挤出机产量/小时

 Tratile / Dies / Matriz / Filières / Trafiladoras / Molde / Фильеры / 模具

 Dimensioni max / Overall dimensions / Abmessungen max / Dimensions max / Dimensiones máx / Dimensões máx / Макс. Габарит / 整机尺寸

 Dimensioni rullo / Roller dimensions / Walze grösse / Dimensions rouleau / Dimensiones rodillo / Dimensões rolos / Размеры роликовые / 滚筒尺寸

 Giri disco / Disc revolutions / Kreislauf / Tours Disques / Vueltas disco / Giros / Обороты диска / 刀盘转速

 Giri / Revolutions / Umdrehungen / Tours / Vueltas / Giros / Обороты/мин ножей / 转

 Capienza utile vasca / Bowl filling level / Becken Nützliche Kapazität / Capacité utile cuve / Capacidad útil tina / Capacidade útil recipiente / Полезный объем емкости / 容器可加入量

 Giri coltelli / Knives revolutions / Umdrehungen messers / Tours couteaux / Vueltas cuchillos / Giros láminas / Скорость вращения ножей / 刀片转速

 Capacità di lavoro / Working capacity / Arbeitsfähigkeit / Capacité de travail / Capacidad de trabajo / Capacidade de trabalho / Объем / 工作能力

 Giri frusta / Whisk revolutions / Umdrehungen Schneebesen / Tours fouet / Vueltas batidor / Giros bater / Обороты Венчик / 搅拌器转速

 Giri rullo / Drum revolutions / Walze Kreislauf / Tours rouleauté / Giros rodillo / Giros cilindro / Обороты валика / 滚筒转速

 Dim. bocca / Mouth dimensions / Öffnung Größe / Dimensions bouche / Dimensiones boca / Dimensões boca / Размеры загрузки. Горловины / 料口尺寸

 Prod. oraria TC / TC Output/h. / TC Leistung/h. / TC Débit/h. / Producción/h. TC / TC produção/h. / Часовая оизводительность TC / TC产量/小时

 Piastra in dotazione / Standard Plate / Scheibe / Filières / Placa en dotación / Lâmina em dotação / Решётка / 标配刀盘

 Potenza assorbita / Absorbed power / Aufgenommene Leistung / Puissance absorbée / Potencia absorvida / Potência absorvida / Потребляемая мощность / 需求功率

 Resa abb. temp. / Chilling efficiency / Kühlleistung / Rendém. refroidiss. rap. / Rendimiento abs. temp. / Rend. Resfriamento ráp. / Эффект охлаждения / 冷藏功效

 Resa surgelazione / Freezing efficiency / Gefrierleistung / Rendément surgélation / Rendimiento congelación / Rend. congelamento / Эффект замораживания / 冷冻功效

 Volume / Volume / Volumen / Volume / Volumen / Volume / Объем / 体积

 Numero teglie / Number of trays / Anzahl bleche / Nombre de bacs / Número de fuentes / Número fórmats / Кол-во gastronемостей / 托盘数量

 Dimensioni interne / Inner dimensions / Garraumabmessungen / Dimensions intérieures / Dimensiones internas / Dimensões internas / Внутренние размеры / 内部尺寸

 Capacità / Capacity / Kapazität / Capacité / Capacidad / Capacidade / Вместимость / 容积

 Ø Macine / Ø Grinders / Ø Mühlen / Ø Meules / Ø Molidos / Ø Moedores / Ø жерновов / 绞肉孔径

## Lavorazione Carne / Meat processors

 Prod. oraria TC / TC Output/h. / TC Leistung/h. / TC Débit/h. / Producción/h. TC / TC produção/h. / Часовая оизводительность TC / TC产量/小时

 Piastra in dotazione / Standard Plate / Scheibe / Filières / Placa en dotación / Lâmina em dotação / Решётка / 标配刀盘

## Ristorazione / Food processors

 Capacità vasca / Bowl capacity / Beken Kapazität / Capacité cuve / Capacidad tina / Capacidade recipiente / Объем бункера / 容器容积

 Capacità impasto / Dough capacity / Teig Kapazität / Capacité pâte / Capacidad masa / Capacidade la massa de pão / Тесто потенциала / 面团容量

 Produzione/h. / Output/h. / Leistung/h. / Débit/h. / Producción/h. / Produção/h. Часовая производительность / 产量/小时

 Capacità vasca / Bowl capacity / Beken Kapazität / Capacité cuve / Capacidad tina / Capacidade recipiente / Объем бункера / 容器容积

 Giri / Revolutions / Umdrehungen / Tours / Vueltas / Giros / Обороты/мин ножей / 转

 Produzione/h. / Output/h. / Leistung/h. / Débit/h. / Producción/h. / Produção/h. Часовая производительность / 产量/小时

 Lame / Blades / Messer / Lame / Cuchillas / Láminas / Кол-во лезвий / 刀片

 Dimensioni vasca / Tank dimensions / Becken abmessungen / Dimensions cuve / Dimensiones cuba / Dimensões tanque / Размеры ванны / 搅拌箱容积

 Capacità / Capacity / Kapazität / Capacité / Capacidad / Capacidade / Вместимость / 容积

 Capacità cilindro / Cylinder capacity / Inhalt Zylinder / Capacité Cylindre / Capacidad cilindro / Capacidade cilindro / Ёмкость цилиндра / 筒容积

 Lunghezza cilindro / Cylinder length / Zylinder lange / Longueur cylindre / Longitud cilindro / Comprimento cilindro / Длина цилиндра / 筒长度

 Diametro cilindro / Cylinder diameter / Zylinder Durchmesser / Diamètre cylindre / Diâmetro cilindro / Diâmetro cilindro / Диаметр цилиндра / 筒直径

 Corsa pistone / Piston stroke / Kolben hob / Course piston / Trayecto pistón / Curso pistão / Шар поршня / 活塞行程

 Imbuti in dotazione Ø int. / Ø Serie exhaust funnels / Ø Zusätzliche trichter / Ø Entonnoir en dotation / Embudos en dotación Ø int. / Ø Funis em dotação / Внутр.Ø прилагаемых воронок / 直径不同的系列漏斗

 Velocità min. svuotamento / Min. forward speed / Langsamere vor. Bewegung / Vitesse minimale vidage / Velocidad min.vaciado / Velocidade min. esvaziamento / Мин.скорость опораживания / 最小推进速度

 Velocità max. svuotamento / Max. forward speed / Schnellere vor. bewegung / Vitesse maximale vidage / Velocidad máx. vaciado / Velocidade máx. esvaziamento / Макс.скорость опораживания / 最大推进速度

 Velocità ritorno pistone / Backward speed / Rückwärts bewegung / Vitesse retour piston / Velocidad regreso pistón / Velocidade retorno pistão / Скорость возврата поршня / 活塞回路速度

 Lunghezza nastro / Blade length / Bandsaegelänge / Longueur lame / Longitud cinta / Comprimento lâmina / Длина лезвия / 刀片长度

 Puleggia / Pulley / Riemenscheibe / Poulie / Polea / Polia / Шкив / 滑轮

 Sup. di lavoro / Working surface / Arbaittisch / Surface de travail / Sup. de trabajo / Sup. Trabalho / Рабочая поверхность / 加工表面

 Termostato / Thermostat / Thermostat / Thermostat / Termóstato / Termóstato / Термостат / 恒温器

 Lunghezza max lama coltello / Max lenght of the blade of the knife / Max Länge der Messerklinge / Longueur max lame couteaux / Longitud máx. hoja cuchillo / Comprimento máx. Lâmina da faca / Макс. длина лезвия ножа / 刀片最大长度

 Q.tà lampade e potenza / Nr. of lamps and power / Nr. Lampen und spannung / Nr. Lampes et puissance / C.dad de lâmparas y potencia / Quant.lâmpadas e potência / Кол-во ламп и их мощность / 灯的数量和功率

 Timer / Timer / Schaltuhr / Timer / Temporizador / Timer / Таймер / 定时器

 Capienza coltelli / Knives capacity / Messer kapazität / Capacité couteaux / Capacidad de cuchillos / Capacidades facas / Кол-во ножей / 刀数量

 Diametro stampo / Diametro mould / Durchmesser form / Diamètre étampe / Diâmetro molde / Diâmetro molde / Диаметр штампа / 磨具直径

 Giri rulli/lame / Revolutions rollers/blades / Umdrehungen Walzen / Messer / Révolutions rouleaux / lames / Giro rodillos/cuchillas / Giros rolos / láminas / Обороты валков/ножей / 滚轴旋转速度

 Dimensioni bocca di carico / Dim. loading hopper / Abmessungen Beladetrichter / Dim. trémies de chargement / Dimensiones tolva de carga / Dimensões tremonha de carga / Размеры загрузки.горловина / 进料口尺寸

 Dimensioni max di lavoro / Working dimensions max / Max abmessungen der Arbeit / Dimensions max de travail / Dimensiones máx de trabajo / Dimensões máx. de trabalho / Рабочие размеры макс / 工作尺寸最大

 Piano di lavoro / Working plate / Arbeitsplatte / Surface de travail / Plano de trabajo / Plano de trabalho / Рабочая поверхность / 工作表面

 Lame / Blades / Klingen / Lames / Cuchillas / Láminas / Кол-во лезвий / 刀片

## Macchine Imballaggio / Packaging machines





-  Rotolo film / Max. film roll / Folienrollen max / Max. bobine film / Rollo película / Bobina película / Рулон пленки макс. / 最大薄膜卷
-  Piano riscaldante / Heating surface / Heizfläche / Plateau chauffant / Plano calentador / Plano de aquecido / Подогреваемая поверхность / 加热表面
-  Dimensioni max vaschetta / Tray max dimensions / Tablettens max Abmessungen / Dimensions max plateau / Dimensões máx bandeja / Dimensões máx bandeja / Лоток Макс размеры / 最大托盘尺寸
-  Pompa del vuoto / Vacuum pump / Vacuum pumpe / Pompe de vide / Bomba de vacío / Bomba de vácuo / Вакуумный насос / 真空泵
-  Barra saldante / Sealing bar / Schweißleiste / Barre de soudre / Barra de sellado / Barra de selagem / Уплотнительная бара / 密封条
-  Dimensioni camera / Cavity dimensions / Kammergröße / Dimensiones de la chambre / Dimensões de la cavidad / Dimensões das cavidades / Размеры полости / 型腔尺寸
-  Dimensioni camera / Cavity dimensions / Kammergröße / Dimensiones de la chambre / Dimensões de la cavidad / Dimensões das cavidades / Размеры полости / 型腔尺寸
-  Taglio film / Film cutting / Folieschnitt / Coupe de la pellicule / Corte de película / Corte filme / Вырезывания пленки / 薄膜切割

-  Dimensioni interne / Inner dimensions / Garraumabmessungen / Dimensions intérieures / Dimensiones internas / Dimensões internas / Внутренние размеры / 内部尺寸
-  Dimensioni vasca cottura / Cooking tray dimensions / Abmessungen vom Kochsraum / Dimensions chambre de cuisson / Dimensiones de la cavidad de cocción / Dimensões das cavidades de cozedura / Кулинария размеры полости / 烹饪型腔尺寸
-  Produzione/h. / Output/h. / Leistung/h. / Débit/h. / Producción/h. / Produção/h. / Часовая производительность / 产量/小时
-  Dimensioni tappeto / Conveyor grid dim. / Fördergitterabmessungen / Dimensions tapis de cuisson / Dim. de la rejilla del transportador / Dimensões da grade do transportador / Размеры конвейерной сетки / 输送机网格尺寸
-  Temperatura / Temperature / Temperatur / Température / Temperatura / Temperatura / Температура / 温度
-  Dim. piano / level dimensions / Stock Abmessungen / Dim. surface / Dimensiones plano / Dimensões do andar / Размеры этаже / 水平尺寸
-  Dim. 2° piano / 2nd level dimensions / 2. Stock Abmessungen / Dim. deuxième surface / Dimensiones segundo plano / Dimensões do segundo andar / размеры второго этаже / 第二层面尺寸
-  Dim. 3° piano / 3rd level dimensions / 3. Stock Abmessungen / Dim. troisième surface / Dimensiones tercer plano / Dimensões do terceiro andar / Размеры третьего этаже / 第三级面尺寸

-  Numero rulli / Rollers number / Rollen Zant / Nombre rouleaux / Número de rodillos / Número rolos / Кол-во роликов / 滚筒数
-  Dimensioni rullo / Roller dimensions / Walze größe / Dimensions rouleau / Dimensiones rodillo / Dimensões rolos / Размеры роликовые / 滚筒尺寸
-  Riscaldatori pane / Bread heaters / Heizung brot / Chauffage pain / Calentador pan / Aquecedor pan / Штыри подгрева / 面包加热机
-  Dim. Cestello / Size of basket / Korbabmessungen / Dimensions panier / Dimensión cesta / Dimensão cesta / Размеры корзины / 筐的尺寸
-  Capacità wurstel / Würstel capacity / Würstel Kapazität / Capacité wurstel / Capacidad salchicha / Capacidade salchicha / Кол-во сосисок / 烤香肠容量
-  Distanza lame / Blades space / Abst. zwischen Messer / Ecartem. des lames / Distancia entre cuchillas / Distância entre as lâminas / Расстояние между лезвиями / 刀片间距
-  Lame / Blades / Messer / Lames / Cuchillas / Lâminas / Кол-во лезвий / 刀片
-  Giri vasca - spirale / Revolutions tank - spiral / Umdrehungen Becken - Spirale / Tours cuve - spirale / Vueltas tina - espiral / Giros recipiente - espiral / Цистернам революций - спираль / 革命坦克 - 螺旋
-  Capacità vasca / Bowl capacity / Beken Kapazität / Capacité cuve / Capacidad tina / Capacidade recipiente / Объем бункера / 容器容积
-  Capacità impasto / Dough capacity / Teig Kapazität / Capacité pâte / Capacidad masa / Capacidade da massa de pão / Тесто потенциала / 面团容量
-  Dimensioni vasca / Tank dimensions / Becken abmessungen / Dimensions cuve / Dimensiones cuba / Dimensão cuba / Размеры ванны / 搅拌箱容积
-  Timer / Timer / Schaltuhr / Timer / Temporizador / Timer / Таймер / 定时器

## Linea Bar / Bar Line

-  Zone riscaldanti / Heating areas / Heizzonen / Zones chauffant / Zonas calentadoras / Zonas de aquecimento / Зоны нагрева / 加热区
-  Sup. utile / Useful surface / Nutzfläche / Surface utile / Superficie útil / Superficie útil / Полезная площадь / 有用表面
-  Dimensioni foro per incasso / Cavity dimensions for built-in models / Lochabmessungen für Einbau / Dimensions trou / Dimensiones orificio para encaje / Dimensões do furo de embutida / Размеры отверстия кассы / 模型内腔尺寸

-  Capacità bicchiere / Jug capacity / Kapazität / Capacité verre / Capacidad vaso / Capacidade copo / Объем стакана / 容器容积
-  Giri / Revolutions / Umdrehungen / Tours / Vueltas / Giros / Обороты/мин ножей / 转
-  Giri/coltello / Blade speed / Drehungen des Messer / Tours lame / Vueltas cuchillos / Giros lâminas / Скорость вращения ножей / 刀片转速
-  Capacità vaschetta / Capacity bowl / Inhalt wanne / Capacité bac / Capacidad recipiente / Capacidade recipiente / Объем бункера / 容器容积
-  Dimensioni interne bicchiere / Mould inside dimensions / Innere Behälter Abmes. / Dim. interieure verre / Dimensiones internas vaso / Dimensão internas copo / Внутренний размер стакана / 漏口内部尺寸

## Snack e Pizza / Snack and Pizza

-  Sup. utile / Useful surface / Nutzfläche / Surface utile / Superficie útil / Superficie útil / Полезная площадь / 有用表面
-  Capacità toast / Toast capacity / Toast Kapazität / Toast capacité / Capacidad emparedados / Capacidade tostadeira / Кол-во тостов / 吐司容量
-  Resistenze al quarzo / Quartz heating elements / Quarz widerstände / Résistances à quartz / Resistencias de cuarzo / Resistência ao quartz / Кварцевые нагревательные / элементы / 石英加热元件
-  Resistenze corazzate / Shock-proof, coated heating elements / Gepanzerte Widerstände / Résistances renforcées / Resistencias acorazadas / Resistência revestida / Армированные нагревательные элементы / 防震涂层加热元件

## Distribuzione Esclusiva / Exclusive distribution

-  Potenza assorbita / Absorbed power / Aufgenommene Leistung / Puissance absorbée / Potencia absorbida / Potência absorbida / Потребляемая мощность / 需求功率
-  Ø Lama / Ø Blade / Ø Messer / Ø Lame / Ø Cuchilla / Ø Lâmina / Ø лезвия / 刀片直径

-  Spessore taglio / Cut thickness / Schnittbreite / Epaisseur de coupe / Espesor corte / Espessura corte / Толщина нарезки / 切削厚度
-  Capacità di taglio / Cut capacity / Schnittgröße / Capacité de coupe / Capacidad de corte / Capacidade de corte / Способность нарезки / 切割长度
-  Dimensioni nastro / Dimensions of the tape / Ausmaße des Bandes / Dimensions bande / Dimensiones cinta / Dimensões esteira / Размеры ленты / 带子尺寸
-  Vassoio / Plate / Platte / Plateau / Plato / Prato / Лоток / 料斗
-  Dimensioni piatto grande / Dimensions of the big plate / Ausmaße des großen Tellers / Dimensions plateau grand / Dimensiones plato grande / Dimensões prato grande / Размеры большого лотка / 大盘尺寸
-  Dimensioni piatto piccolo / Dimensions of the small plate / Ausmaße des kleinen Tellers / Dimensions petit plateau / Dimensiones plato pequeño / Dimensões prato pequeno / Размеры маленький лотка / 小盘尺寸
-  Dimensioni max / Overall dimensions / Abmessungen max / Dimensions max / Dimensiones máx / Dimensões máx / Макс. Габарит / 整机尺寸
-  Campo di pesata / Shipping weight / Abwiegenfeld / Portée / Campo de peso / Campo de péso / Поле взвешивания / 毛重
-  Precisione di indicazione / Precision / Genauigkeitsgrad / Précision d'indication / Precisión de indicación / Índice de precisão / Точность показаний / 精度
-  Dimensioni piatto / Pan dimensions / Abmessungen des Teller / Dimensions plateau / Dimensiones plato / Dimensões prato / Размеры лотка / 面板尺寸
-  Giri/lama / Blade speed / Drehungen des Messer / Tours lame / Vueltas cuchillos / Giros lâminas / Скорость вращения ножей / 刀片转速
-  Pressione aria / Air pressure / Luftdrücken / Pression air / Presión aire / Pressão ar / Давление воздуха / 气压
-  Capacità bicchiere / Jug capacity / Kapazität / Capacité verre / Capacidad vaso / Capacidade copo / Объем стакана / 容器容积
-  Temperatura di lavorazione / Processing temperature / Arbeit-Temperatur / Température de travail / Temperatura de elaboración / Temperatura elaboração / Температура обработки / 加工温度
-  Sup. utile / Useful surface / Nutzfläche / Surface utile / Superficie útil / Superficie útil / Полезная площадь / 有用表面
-  Temperatura / Temperature / Temperatur / Température / Temperatura / Temperatura / Температура / 温度
-  Capacità vasca / Bowl capacity / Beken Kapazität / Capacité cuve / Capacidad tina / Capacidade recipiente / Объем бункера / 容器容积
-  Porzioni / Portions / Portionen / Portions / Raciones / Porções / Кол-во порций / 比例
-  Tempo max di mantenimento / Max time period for upkeep / Max Garungsdauer / Temps max de maintien au chaud / Tiempo máx de mantenimiento / Tempo máx. de mantenimiento / Макс. Время хранения / 最长保养期
-  Potenza resa / Output power / Ausgang Leistung / Puissance restituée / Potencia de rendimento / Potência de rendimento / Отдаваемая мощность / 输出功率
-  Livelli di potenza microonde / Microwaves power levels / Mikrowellen Leistungsstufen / Niveaux de puissance micro-ondes / Niveles de potencia microondas / Niveis de potência microondas / Микроволновые печи уровнях власти / 微波功率水平
-  Livelli di potenza grill / Grill power levels / Grill Leistungsstufen / Niveaux de puissance Grill / Niveles de potencia grill / Niveis de potência grade / уровнях Мощность гриля / 功率级别烧烤
-  Timer / Timer / Schaltuhr / Timer / Temporizador / Timer / Таймер / 定时器
-  Volume / Volume / Volumen / Volume / Volumen / Volume / Объем / 体积
-  Dimensioni interne / Inner dimensions / Garraumabmessungen / Dimensions intérieures / Dimensiones internas / Dimensões internas / Внутренние размеры / 内部尺寸
-  Magnetron / Magnetrons / Magnetransnommer / Magnétrons / Magnetrones / Magnetron / Магнетрон / 磁控管
-  Frequenza microonde / Microwave frequency / Mikrowellenfrequenz / Fréquence micro-ondes / Frecuencia microondas / Frequência das microondas / Частота микроволн / 微波频率
-  Grill livelli 1-2 / Grill levels 1-2 / Grill Ebene 1-2 / Grill nivel 1-2 / Grill nivel 1-2 / Гриль уровень 1-2 / 烤盘的层数为 1-2
-  Conveccion / Convection cooking / Umluft / Convection / Convección / Convecção / Конвекция / 对流烹饪
-  Rotolo film / Max. film roll / Folienrollen max / Max. bobine film / Rollo película / Bobina película / Рулон пленки макс. / 最大薄膜卷
-  Piano riscaldante / Heating surface / Heizfläche / Plateau chauffant / Plano calentador / Plano de aquecido / Подогреваемая поверхность / 加热表面
-  Temperatura di sigillatura / Sealing temperature / Siegeltemperatur / Température de sceller / Temperatura de sellado / Temperatura de sigilação / Температура запайки / 封装温度
-  Tempo di sigillatura / Sealing time / Siegelzeit / Temps de sceller / Tiempo de sellado / Tempo de sigilação / Время запайки / 封装时间
-  Tempo di sigillatura regolato / Programmed sealing time / Sealing Zeit angepasst / Temps de sceller réglé / Tiempo de sellado regulado / Tempo de sigilação / Установленное время запайки / 调节封装时间
-  Lunghezza sigillatura / Sealing length / Siegel-Länge / Longueur de sceller / Longitud sellado / Comprimento sigilação / Длина шва запайки / 封装长度
-  Spessore sigillatura / Sealing thickness / Siegelstärke / Épaisseur de sceller / Espesor sellado / Espessura sigilação / Толщина шва запайки / 封装厚度
-  Giri frusta / Whisk revolutions / Umdrehungen Schneebesen / Tours fouet / Vueltas batidor / Giros bater / Обороты Венчик / 搅拌机转速
-  Capacità vasca / Bowl capacity / Beken Kapazität / Capacité cuve / Capacidad tina / Capacidade recipiente / Объем бункера / 容器容积
-  Dimensioni cestello / Basket dimensions / Korbabmessungen / Dimensions du panier / Dimensión cesta / Dimensões cesta / Размеры корзинки / 筐的尺寸
-  Capacità impasto / Dough capacity / Teig Kapazität / Capacité pâte / Capacidad masa / Capacidade la massa de pão / Тесто потенциала / 面团容量
-  Peso pasta / Dough weight / Gewicht d. Teiges / Poids pâte / Peso de la masa / Peso da massa / Macca теста / 面团的重量
-  Potenza induzione / Induction power / Induktion Macht / Puissance de induction / Potencia de inducción / Potência de indução / Мощность индукции / 感应功率
-  Livelli velocità / Speed levels / Geschwindigkeitsstufen / Niveaux de vitesse / Niveles de velocidad / Niveis de velocidade / Скорость уровней / 速度水平
-  Giri coltelli / Knives revolutions / Umdrehungen messers / Tours couteaux / Vueltas cuchillos / Giros lâminas / Скорость вращения ножей / 刀片转速
-  Capacità di lavoro / Working capacity / Arbeitsfähigkeit / Capacité de travail / Capacidad de trabajo / Capacidade de trabalho / Объем / 工作能力
-  Giri / Revolutions / Umdrehungen / Tours / Vueltas / Giros / Обороты/мин ножей / 转
-  Dimensioni tramoggia / Hopper dimensions / Öffnung Größe / Dimensions bouche / Dimensiones boca / Dimensões boca / Размеры загруз. Горловины / 料口尺寸
-  Zone refrigerate / Refrigerated zone / Kühlzone / Zone réfrigérée / Zonas refrigerados / Areas refrigeradas / Охлаждаемые отсеки / 冷藏区域
-  Capacità max bottiglie / Max capacity bottles / Max Kapazität Flaschen / Max capacité Bouteilles / Capacidad máx de botellas / Capacidade máx de garrafas / Макс. вместимость бутылок / 可装瓶数
-  GAS Gas / Газ / 氣的
-  Pressione acqua / Water pressure / Wasserdruck / Pression de l'eau / Presión del agua / Pressão de água / Давление воды / 水压
-  Velocità centrifuga / Spin speed / Schleuderdrehzahl / Vitesse d'essorage / Velocidad de centrifugado / Velocidade de centrifugação / Макс. скорость отжима / 最大脱水速度
-  Capacità / Capacity / Kapazität / Capacité / Capacidad / Capacidade / Вместимость / 容积
-  Dimensioni cestello / Drum dimensions / Trommel Abmessungen / dimensions tambour / Dimensiones cesta / Dimensões da cesta / Размеры барабана / 滚筒尺寸
-  Potenza assorbita senza calore / Power consuption no heat / Aufgenommene Leistung ohne Wärme / Puissance absorbée sans chauffage / Potencia absorvida sin calor / Potência absorvida sem calor / Потребляемая мощность без подогревания / 不带加热的能耗
-  Potenza assorbita con calore / Power consuption heating / Aufgenommene Leistung mit Wärme / Puissance absorbée avec chauffage / Potencia absorvida con el calor / Potência absorvida com o calor / Потребляемая мощность с подогреванием / 带加热的能耗
-  Potenza riscaldamento / Heater rating / Leistung Erwärmung / Puissance de chauffage / Potencia de calefacción / Potência calorífica / Мощность подогревания / 加热器功率

